

## REGULATORY COMPLIANCE



## ITEM DESCRIPTION

Watch Crystal Resonator 3.7mm x 7.9mm x 2.5mm 4 Pad Plastic Surface Mount (SMD)

## ELECTRICAL SPECIFICATIONS

Nominal Frequency	32.768kHz
Frequency Tolerance	±20ppm at 25°C
Frequency Stability Temperature Coefficient	-0.034±0.006ppm/(Change in °C) <sup>2</sup> Maximum
Turn over Temperature	25°C ±5°C
Aging at 25°C	±3ppm/year Maximum
Operating Temperature Range	-40°C to +85°C
Load Capacitance	6 pF Parallel Resonant 12.5pF Parallel Resonant
Shunt Capacitance	1.35pF Typical
Motional Capacitance	3.0fF Typical
Equivalent Series Resistance	50,000 Ohms Maximum
Mode of Operation	Fundamental
Drive Level	1µWatt Maximum
Crystal Cut	Tuning Fork
Storage Temperature Range	-55°C to +125°C
Insulation Resistance	Measured at 100Vdc 500 Megaohms Minimum

## PART NUMBERING GUIDE

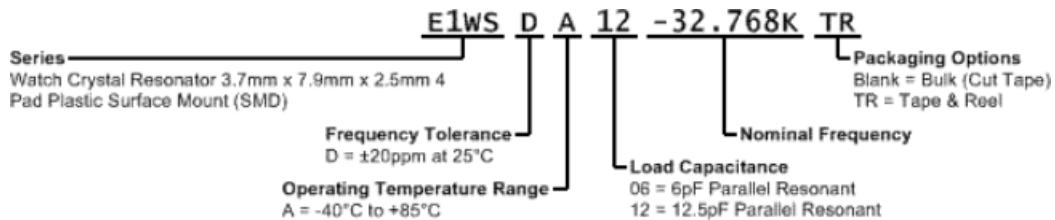

**MECHANICAL DIMENSIONS**

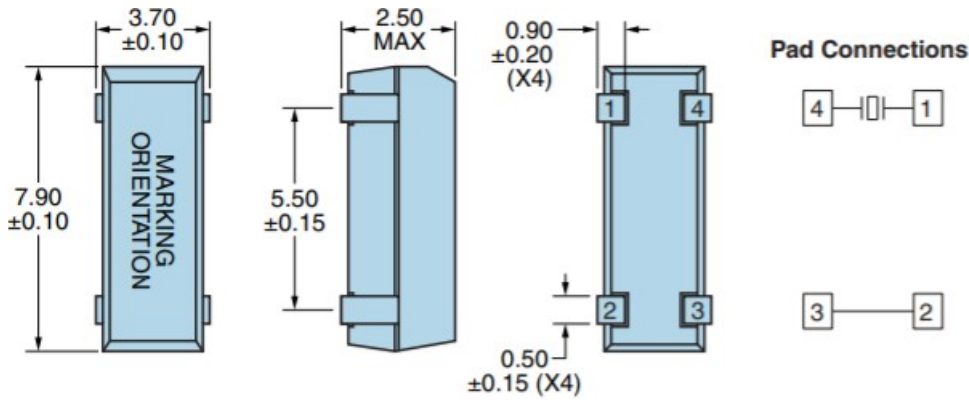

**SUGGESTED SOLDER PAD LAYOUT**

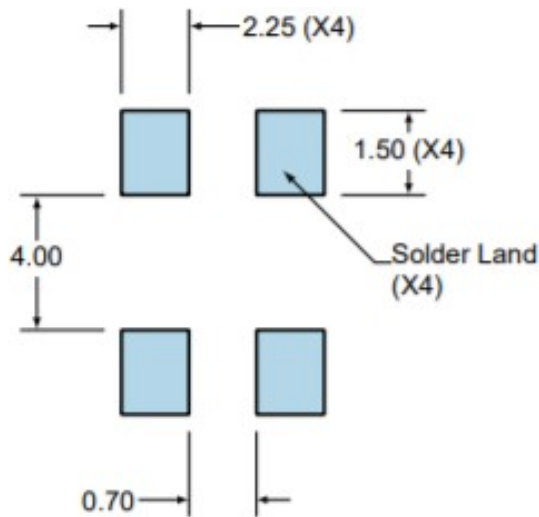

PIN	CONNECTION
1	Crystal
2	No Connect to Pin 3
3	No Connect to Pin 2
4	Crystal

All Tolerances are ±0.1

**All Dimensions in Millimeters**

## TAPE & REEL DIMENSIONS

Quantity per Reel: 3000 Units

All Dimensions in Millimeters

Compliant to EIA-481

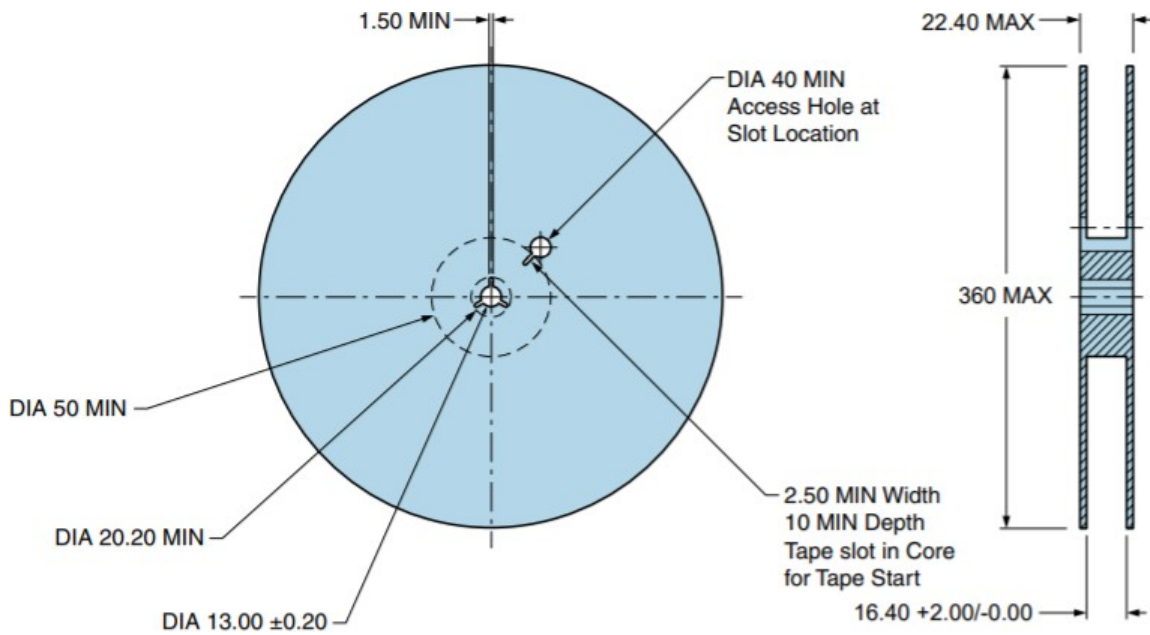
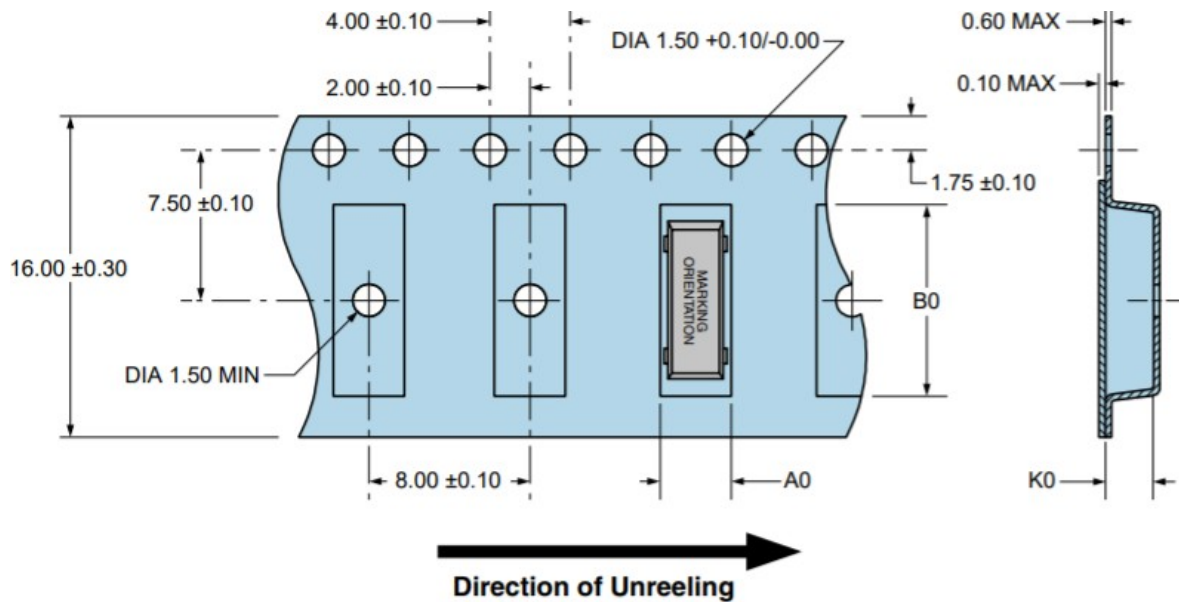

RECOMMENDED SOLDER REFLOW METHOD

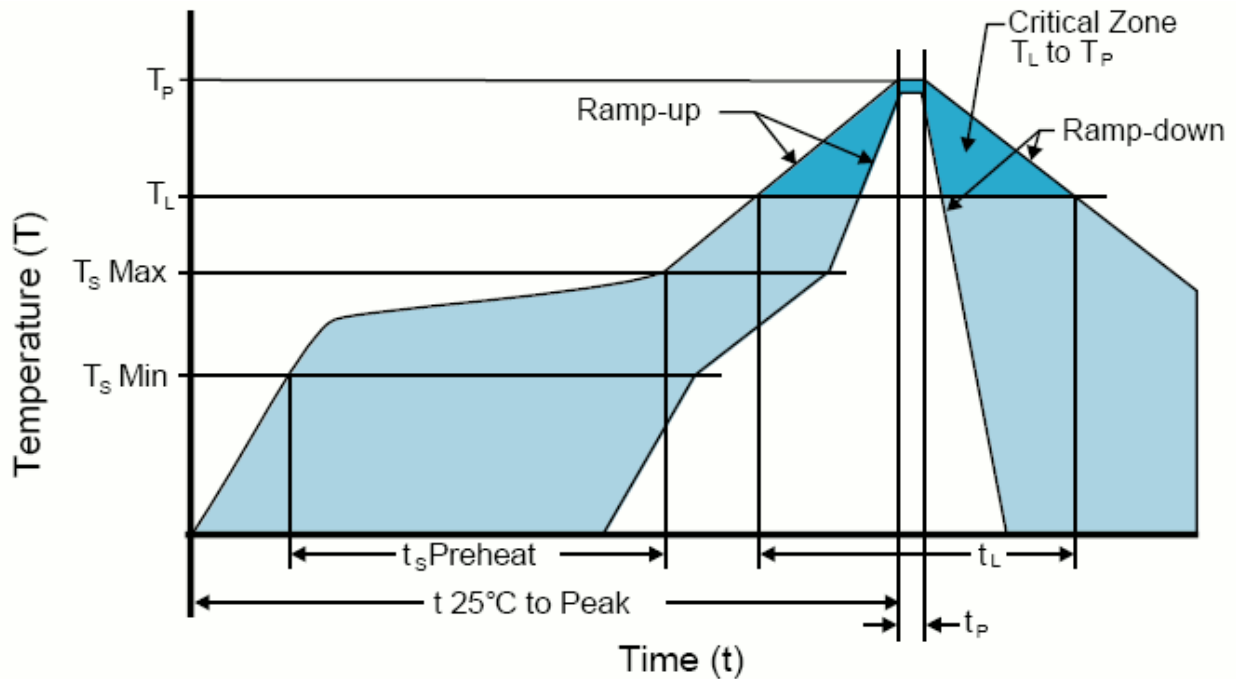

**HIGH TEMPERATURE INFRARED/CONVECTION**

T <sub>S</sub> MAX to T <sub>L</sub> (Ramp-up Rate)	3°C/Second Maximum
<b>Preheat</b>	
- Temperature Minimum (T <sub>S</sub> MIN)	150°C
- Temperature Typical (T <sub>S</sub> TYP)	175°C
- Temperature Maximum(T <sub>S</sub> MAX)	200°C
- Time (t <sub>s</sub> )	60 - 180 Seconds
<b>Ramp-up Rate (T<sub>L</sub> to T<sub>P</sub>)</b>	3°C/Second Maximum
<b>Time Maintained Above:</b>	
- Temperature (T <sub>L</sub> )	217°C
- Time (t <sub>L</sub> )	60 - 150 Seconds
<b>Peak Temperature (T<sub>P</sub>)</b>	260°C Maximum for 10 Seconds Maximum
<b>Target Peak Temperature(T<sub>P</sub> Target)</b>	250°C +0/-5°C
<b>Time within 5°C of actual peak (t<sub>p</sub>)</b>	20 - 40 Seconds
<b>Ramp-down Rate</b>	6°C/Second Maximum
<b>Time 25°C to Peak Temperature (t)</b>	8 Minutes Maximum
<b>Moisture Sensitivity Level</b>	Level 1
<b>Additional Notes</b>	Temperatures shown are applied to body of device.

**High Temperature Manual Soldering**

260°C Maximum for 5 Seconds Maximum, 2 times Maximum. (Temperatures shown are applied to body of device.)

RECOMMENDED SOLDER REFLOW METHOD

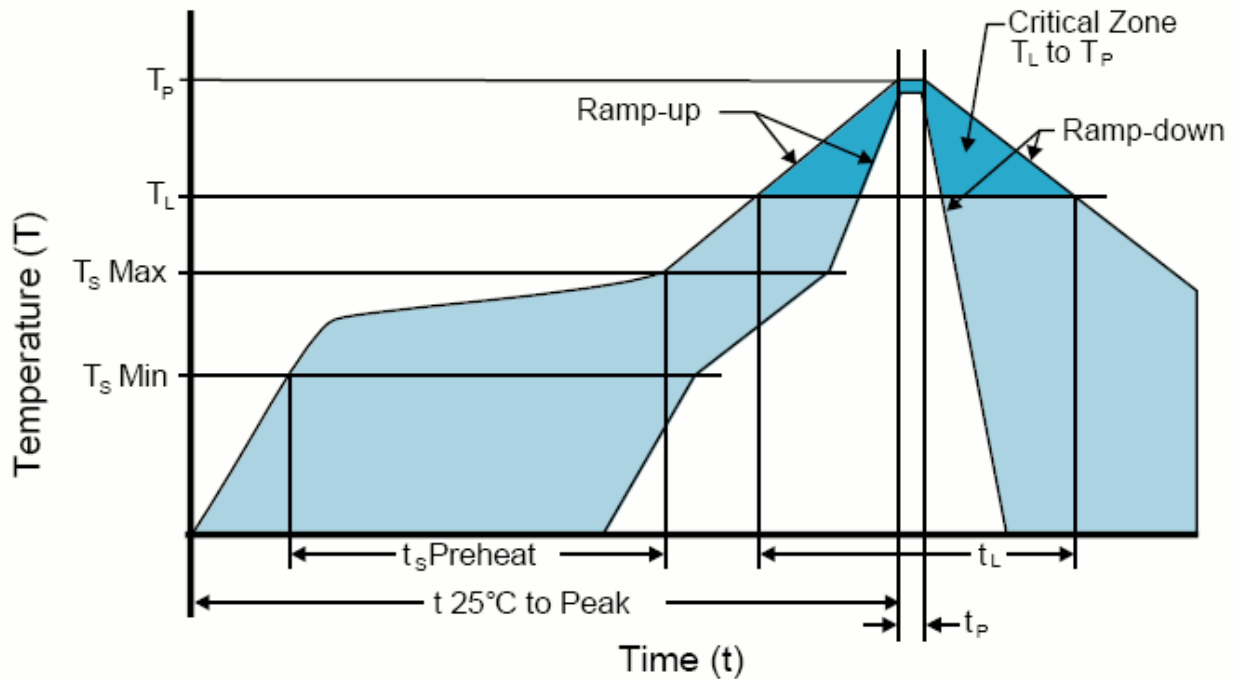

LOW TEMPERATURE INFRARED/CONVECTION	
T <sub>s</sub> MAX to T <sub>L</sub> (Ramp-up Rate)	5°C/Second Maximum
<b>Preheat</b>	
- Temperature Minimum (T <sub>s</sub> MIN)	N/A
- Temperature Typical (T <sub>s</sub> TYP)	150°C
- Temperature Maximum(T <sub>s</sub> MAX)	N/A
- Time (t <sub>s</sub> )	30 - 60 Seconds
Ramp-up Rate (T <sub>L</sub> to T <sub>P</sub> )	5°C/Second Maximum
<b>Time Maintained Above:</b>	
- Temperature (T <sub>L</sub> )	150°C
- Time (t <sub>L</sub> )	200 Seconds Maximum
Peak Temperature (T <sub>P</sub> )	245°C Maximum
Target Peak Temperature (T <sub>P</sub> Target)	245°C Maximum 2 Times / 230°C Maximum 1 Time
Time within 5°C of actual peak (t <sub>p</sub> )	10 Seconds Maximum 2 Times / 80 Seconds Maximum 1 Time
Ramp-down Rate	5°C/Second Maximum
Time 25°C to Peak Temperature (t)	N/A
Moisture Sensitivity Level	Level 1
Additional Notes	Temperatures shown are applied to body of device.

Low Temperature Manual Soldering

185°C Maximum for 10 Seconds Maximum, 2 times Maximum. (Temperatures shown are applied to body of device.)