

## 2.8 W filter-free mono class D audio power amplifier

Datasheet - production data

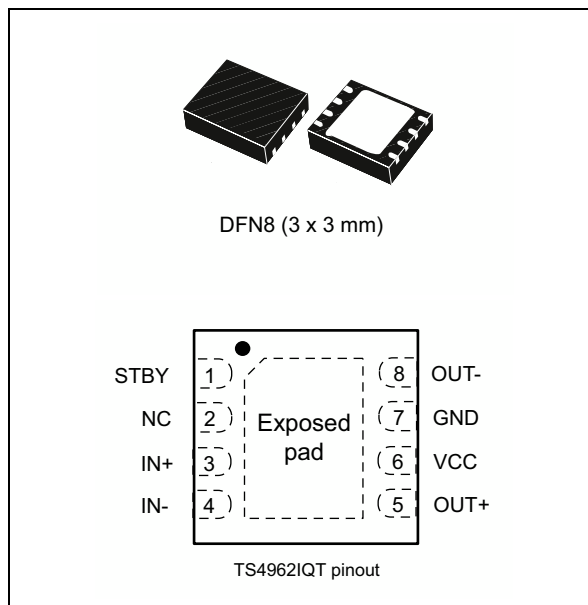

### Applications

- Cellular phones
- PDAs
- Notebook PCs

### Description

The TS4962 is a differential class-D BTL power amplifier. It can drive up to 2.2 W into a 4  $\Omega$  load and 1.4 W into an 8  $\Omega$  load at 5 V. It achieves outstanding efficiency (88% typ.) compared to standard AB-class audio amps.

The gain of the device can be controlled via two external gain setting resistors. Pop and click reduction circuitry provides low on/off switch noise while allowing the device to start within 5 ms. A standby function (active low) enables the current consumption to be reduced to 10 nA typical.

### Features

- Operating from  $V_{CC} = 2.4$  V to 5.5 V
- Standby mode active low
- Output power: 2.8 W into 4  $\Omega$  and 1.7 W into 8  $\Omega$  with 10% THD+N maximum and 5 V power supply
- Output power: 2.2 W at 5 V or 0.7 W at 3.0 V into 4  $\Omega$  with 1% THD+N maximum
- Output power: 1.4 W at 5 V or 0.5 W at 3.0 V into 8  $\Omega$  with 1% THD+N maximum
- Adjustable gain via external resistors
- Low current consumption 2 mA at 3 V
- Efficiency: 88% typical
- Signal to noise ratio: 85 dB typical
- PSRR: 63 dB typical at 217 Hz with 6 dB gain
- PWM base frequency: 280 kHz
- Low pop and click noise
- Available in DFN8 3 x 3 mm package

# Contents

<b>1</b>	<b>Absolute maximum ratings and operating conditions</b>	<b>3</b>
<b>2</b>	<b>Application overview</b>	<b>5</b>
<b>3</b>	<b>Electrical characteristics</b>	<b>7</b>
3.1	Electrical characteristics curves	19
<b>4</b>	<b>Application information</b>	<b>30</b>
4.1	Differential configuration principle	30
4.2	Gain in typical application schematic	30
4.3	Common-mode feedback loop limitations	31
4.4	Low frequency response	31
4.5	Decoupling of the circuit	32
4.6	Wake-up time ( $t_{WU}$ )	32
4.7	Shutdown time ( $t_{STBY}$ )	32
4.8	Consumption in standby mode	32
4.9	Single-ended input configuration	33
4.10	Output filter considerations	34
4.11	Several examples with summed inputs	35
4.11.1	Example 1: dual differential inputs	35
4.11.2	Example 2: one differential input plus one single-ended input	36
<b>5</b>	<b>Demonstration board</b>	<b>37</b>
<b>6</b>	<b>Recommended footprint</b>	<b>39</b>
<b>7</b>	<b>Package information</b>	<b>40</b>
<b>8</b>	<b>Ordering information</b>	<b>42</b>
<b>9</b>	<b>Revision history</b>	<b>43</b>

# 1 Absolute maximum ratings and operating conditions

**Table 1. Absolute maximum ratings**

Symbol	Parameter	Value	Unit
$V_{CC}$	Supply voltage <sup>(1) (2)</sup>	6	V
$V_i$	Input voltage <sup>(3)</sup>	GND to $V_{CC}$	V
$T_{oper}$	Operating free air temperature range	-40 to + 85	°C
$T_{stg}$	Storage temperature	-65 to +150	°C
$T_j$	Maximum junction temperature	150	°C
$R_{thja}$	Thermal resistance junction to ambient DFN8 package	120	°C/W
$P_d$	Power dissipation	Internally limited <sup>(4)</sup>	
ESD	Human body model <sup>(5)</sup>	2	kV
	Machine model <sup>(6)</sup>	200	V
	Charged device model <sup>(7)</sup>		
Latch-up	Latch-up immunity	200	mA
$V_{STBY}$	Standby pin maximum voltage <sup>(8)</sup>	GND to $V_{CC}$	V
	Lead temperature (soldering, 10sec)	260	°C

1. Caution: this device is not protected in the event of abnormal operating conditions such as short-circuiting between any one output pin and ground or between any one output pin and  $V_{CC}$ , and between individual output pins.
2. All voltage values are measured with respect to the ground pin.
3. The magnitude of the input signal must never exceed  $V_{CC} + 0.3$  V/GND - 0.3 V.
4. Exceeding the power derating curves during a long period will provoke abnormal operation.
5. Human body model: a 100 pF capacitor is charged to the specified voltage, then discharged through a 1.5 k $\Omega$  resistor between two pins of the device. This is done for all couples of connected pin combinations while the other pins are floating.
6. Machine model: a 200 pF capacitor is charged to the specified voltage, then discharged directly between two pins of the device with no external series resistor (internal resistor < 5  $\Omega$ ). This is done for all couples of connected pin combinations while the other pins are floating.
7. Charged device model: all pins and the package are charged together to the specified voltage and then discharged directly to the ground through only one pin. This is done for all pins.
8. The magnitude of the standby signal must never exceed  $V_{CC} + 0.3$  V/GND - 0.3 V.

**Table 2. Dissipation ratings**

Package	Derating factor	Power rating at 25°C	Power rating at 85°C
DFN8	20 mW/°C	2.5 W	1.3 W

Table 3. Operating conditions

Symbol	Parameter	Value	Unit
$V_{CC}$	Supply voltage <sup>(1)</sup>	2.4 to 5.5	V
$V_{IC}$	Common mode input voltage range <sup>(2)</sup>	0.5 to $V_{CC}-0.8$	V
$V_{STBY}$	Standby voltage input: <sup>(3)</sup> Device ON Device OFF	$1.4 \leq V_{STBY} \leq V_{CC}$ $GND \leq V_{STBY} \leq 0.4$ <sup>(4)</sup>	V
$R_L$	Load resistor	$\geq 4$	$\Omega$
$R_{thja}$	Thermal resistance junction to ambient DFN8 package <sup>(5)</sup>	50	$^{\circ}X/\Omega$

1. For  $V_{CC}$  between 2.4 V and 2.5 V, the operating temperature range is reduced to  $0^{\circ}C \leq T_{amb} \leq 70^{\circ}C$ .
2. For  $V_{CC}$  between 2.4V and 2.5V, the common mode input range must be set at  $V_{CC}/2$ .
3. Without any signal on  $V_{STBY}$ , the device will be in standby.
4. Minimum current consumption is obtained when  $V_{STBY} = GND$ .
5. When mounted on a 4-layer PCB.

## 2 Application overview

**Table 4. External component information**

Component	Functional description
$C_S$	Bypass supply capacitor. Install as close as possible to the TS4962 to minimize high-frequency ripple. A 100 nF ceramic capacitor should be added to enhance the power supply filtering at high frequencies.
$R_{in}$	Input resistor used to program the TS4962's differential gain (gain = $300 \text{ k}\Omega/R_{in}$ with $R_{in}$ in $\text{k}\Omega$ ).
Input capacitor	Because of common-mode feedback, these input capacitors are optional. However, they can be added to form with $R_{in}$ a 1st order high-pass filter with -3 dB cut-off frequency = $1/(2*\pi*R_{in}*C_{in})$ .

**Table 5. Pin description**

Pin number	Pin name	Description
1	STBY	Standby input pin (active low)
2	NC	No internal connection pin
3	IN+	Positive input pin
4	IN-	Negative input pin
5	OUT+	Positive output pin
6	VCC	Power supply input pin
7	GND	Ground input pin
8	OUT-	Negative output pin
	Exposed pad	Exposed pad can be connected to ground (pin 7) or left floating

Figure 1. Typical application schematics

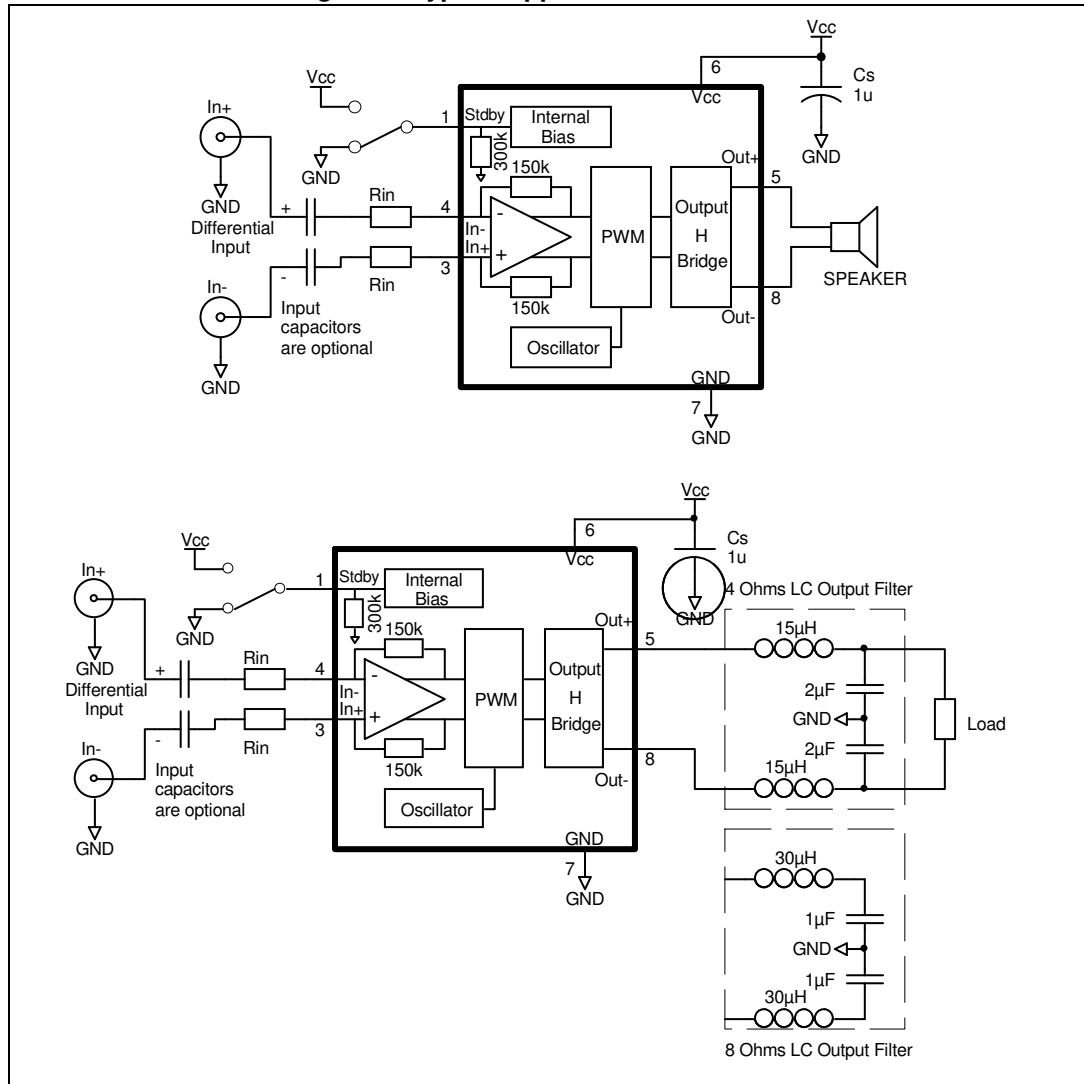

### 3 Electrical characteristics

**Table 6. Electrical characteristics at  $V_{CC} = +5\text{ V}$ ,  
with  $GND = 0\text{ V}$ ,  $V_{icm} = 2.5\text{ V}$ , and  $T_{amb} = 25^\circ\text{C}$  (unless otherwise specified)**

Symbol	Parameter	Min.	Typ.	Max.	Unit
$I_{CC}$	Supply current No input signal, no load		2.3	3.3	mA
$I_{STBY}$	Standby current <sup>(1)</sup> No input signal, $V_{STBY} = GND$		10	1000	nA
$V_{oo}$	Output offset voltage No input signal, $R_L = 8\ \Omega$		3	25	mV
$P_{out}$	Output power, $G = 6\text{ dB}$ THD = 1% max, $f = 1\text{ kHz}$ , $R_L = 4\ \Omega$ THD = 10% max, $f = 1\text{ kHz}$ , $R_L = 4\ \Omega$ THD = 1% max, $f = 1\text{ kHz}$ , $R_L = 8\ \Omega$ THD = 10% max, $f = 1\text{ kHz}$ , $R_L = 8\ \Omega$		2.2 2.8 1.4 1.7		W
THD + N	Total harmonic distortion + noise $P_{out} = 850\text{ mW}_{RMS}$ , $G = 6\text{ dB}$ , $20\text{ Hz} < f < 20\text{ kHz}$ $R_L = 8\ \Omega + 15\ \mu\text{H}$ , $BW < 30\text{ kHz}$ $P_{out} = 1\text{ W}_{RMS}$ , $G = 6\text{ dB}$ , $f = 1\text{ kHz}$ $R_L = 8\ \Omega + 15\ \mu\text{H}$ , $BW < 30\text{ kHz}$		2 0.4		%
Efficiency	Efficiency $P_{out} = 2\text{ W}_{RMS}$ , $R_L = 4\ \Omega + 15\ \mu\text{H}$ $P_{out} = 1.2\text{ W}_{RMS}$ , $R_L = 8\ \Omega + 15\ \mu\text{H}$		78 88		%
PSRR	Power supply rejection ratio with inputs grounded <sup>(2)</sup> $f = 217\text{ Hz}$ , $R_L = 8\ \Omega$ , $G = 6\text{ dB}$ , $V_{ripple} = 200\text{ mV}_{pp}$		63		dB
CMRR	Common mode rejection ratio $f = 217\text{ Hz}$ , $R_L = 8\ \Omega$ , $G = 6\text{ dB}$ , $\Delta V_{ic} = 200\text{ mV}_{pp}$		57		dB
Gain	Gain value ( $R_{in}$ in $k\Omega$ )	$\frac{273k\Omega}{R_{in}}$	$\frac{300k\Omega}{R_{in}}$	$\frac{327k\Omega}{R_{in}}$	V/V
$R_{STBY}$	Internal resistance from standby to GND	273	300	327	$k\Omega$
$F_{PWM}$	Pulse width modulator base frequency	200	280	360	kHz
SNR	Signal to noise ratio (A weighting), $P_{out} = 1.2\text{ W}$ , $R_L = 8\ \Omega$		85		dB
$t_{WU}$	Wake-up time		5	10	ms
$t_{STBY}$	Standby time		5	10	ms

**Table 6. Electrical characteristics at  $V_{CC} = +5\text{ V}$ ,  
with  $GND = 0\text{ V}$ ,  $V_{icm} = 2.5\text{ V}$ , and  $T_{amb} = 25^\circ\text{C}$  (unless otherwise specified)  
(continued)**

Symbol	Parameter	Min.	Typ.	Max.	Unit
$V_N$	Output voltage noise $f = 20\text{ Hz to } 20\text{ kHz}$ , $G = 6\text{ dB}$				$\mu\text{V}_{\text{RMS}}$
	Unweighted $R_L = 4\ \Omega$		85		
	A-weighted $R_L = 4\ \Omega$		60		
	Unweighted $R_L = 8\ \Omega$		86		
	A-weighted $R_L = 8\ \Omega$		62		
	Unweighted $R_L = 4\ \Omega + 15\ \mu\text{H}$		83		
	A-weighted $R_L = 4\ \Omega + 15\ \mu\text{H}$		60		
	Unweighted $R_L = 4\ \Omega + 30\ \mu\text{H}$		88		
	A-weighted $R_L = 4\ \Omega + 30\ \mu\text{H}$		64		
	Unweighted $R_L = 8\ \Omega + 30\ \mu\text{H}$		78		
	A-weighted $R_L = 8\ \Omega + 30\ \mu\text{H}$		57		
	Unweighted $R_L = 4\ \Omega + \text{filter}$		87		
	A-weighted $R_L = 4\ \Omega + \text{filter}$		65		
	Unweighted $R_L = 4\ \Omega + \text{filter}$		82		
A-weighted $R_L = 4\ \Omega + \text{filter}$		59			

1. Standby mode is active when  $V_{\text{STBY}}$  is tied to GND.
2. Dynamic measurements -  $20 \cdot \log(\text{rms}(V_{\text{out}})/\text{rms}(V_{\text{ripple}}))$ .  $V_{\text{ripple}}$  is the superimposed sinusoidal signal to  $V_{CC}$  at  $f = 217\text{ Hz}$ .



**Table 7. Electrical characteristics at  $V_{CC} = +4.2\text{ V}$  with  $GND = 0\text{ V}$ ,  $V_{icm} = 2.1\text{ V}$  and  $T_{amb} = 25^\circ\text{C}$  (unless otherwise specified)<sup>(1)</sup>**

Symbol	Parameter	Min.	Typ.	Max.	Unit
$I_{CC}$	Supply current No input signal, no load		2.1	3	mA
$I_{STBY}$	Standby current <sup>(2)</sup> No input signal, $V_{STBY} = GND$		10	1000	nA
$V_{oo}$	Output offset voltage No input signal, $R_L = 8\ \Omega$		3	25	mV
$P_{out}$	Output power, $G = 6\text{ dB}$ THD = 1% max, $f = 1\text{ kHz}$ , $R_L = 4\ \Omega$ THD = 10% max, $f = 1\text{ kHz}$ , $R_L = 4\ \Omega$ THD = 1% max, $f = 1\text{ kHz}$ , $R_L = 8\ \Omega$ THD = 10% max, $f = 1\text{ kHz}$ , $R_L = 8\ \Omega$		1.5 1.95 0.9 1.1		W
THD + N	Total harmonic distortion + noise $P_{out} = 600\text{ mW}_{RMS}$ , $G = 6\text{ dB}$ , $20\text{ Hz} < f < 20\text{ kHz}$ $R_L = 8\text{ W} + 15\ \mu\text{H}$ , $BW < 30\text{ kHz}$ $P_{out} = 700\text{ mW}_{RMS}$ , $G = 6\text{ dB}$ , $f = 1\text{ kHz}$ $R_L = 8\text{ W} + 15\ \mu\text{H}$ , $BW < 30\text{ kHz}$		2 0.35		%
Efficiency	Efficiency $P_{out} = 1.45\text{ W}_{RMS}$ , $R_L = 4\ \Omega + \geq 15\ \mu\text{H}$ $P_{out} = 0.9\text{ W}_{RMS}$ , $R_L = 8\text{ W} + \geq 15\ \mu\text{H}$		78 88		%
PSRR	Power supply rejection ratio with inputs grounded <sup>(3)</sup> $f = 217\text{ Hz}$ , $R_L = 8\ \Omega$ , $G = 6\text{ dB}$ , $V_{ripple} = 200\text{ mV}_{pp}$		63		dB
CMRR	Common mode rejection ratio $f = 217\text{ Hz}$ , $R_L = 8\ \Omega$ , $G = 6\text{ dB}$ , $\Delta V_{ic} = 200\text{ mV}_{pp}$		57		dB
Gain	Gain value ( $R_{in}$ in $k\Omega$ )	$\frac{273k\Omega}{R_{in}}$	$\frac{300k\Omega}{R_{in}}$	$\frac{327k\Omega}{R_{in}}$	V/V
$R_{STBY}$	Internal resistance from standby to GND	273	300	327	$k\Omega$
$F_{PWM}$	Pulse width modulator base frequency	200	280	360	kHz
SNR	Signal to noise ratio (A-weighting) $P_{out} = 0.8\text{ W}$ , $R_L = 8\ \Omega$		85		dB
$t_{WU}$	Wake-up time		5	10	ms
$t_{STBY}$	Standby time		5	10	ms

**Table 7. Electrical characteristics at  $V_{CC} = +4.2\text{ V}$  with  $GND = 0\text{ V}$ ,  $V_{icm} = 2.1\text{ V}$  and  $T_{amb} = 25^\circ\text{C}$  (unless otherwise specified)<sup>(1)</sup> (continued)**

Symbol	Parameter	Min.	Typ.	Max.	Unit
$V_N$	Output voltage noise $f = 20\text{ Hz to } 20\text{ kHz}$ , $G = 6\text{ dB}$				$\mu\text{V}_{\text{RMS}}$
	Unweighted $R_L = 4\ \Omega$		85		
	A-weighted $R_L = 4\ \Omega$		60		
	Unweighted $R_L = 8\ \Omega$		86		
	A-weighted $R_L = 8\ \Omega$		62		
	Unweighted $R_L = 4\ \Omega + 15\ \mu\text{H}$		83		
	A-weighted $R_L = 4\ \Omega + 15\ \mu\text{H}$		60		
	Unweighted $R_L = 4\ \Omega + 30\ \mu\text{H}$		88		
	A-weighted $R_L = 4\ \Omega + 30\ \mu\text{H}$		64		
	Unweighted $R_L = 8\ \Omega + 30\ \mu\text{H}$		78		
	A-weighted $R_L = 8\ \Omega + 30\ \mu\text{H}$		57		
	Unweighted $R_L = 4\ \Omega + \text{filter}$		87		
	A-weighted $R_L = 4\ \Omega + \text{filter}$		65		
	Unweighted $R_L = 4\ \Omega + \text{filter}$		82		
A-weighted $R_L = 4\ \Omega + \text{filter}$		59			

1. All electrical values are guaranteed with correlation measurements at 2.5 V and 5 V.
2. Standby mode is active when  $V_{\text{STBY}}$  is tied to GND.
3. Dynamic measurements -  $20 \cdot \log(\text{rms}(V_{\text{out}})/\text{rms}(V_{\text{ripple}}))$ .  $V_{\text{ripple}}$  is the superimposed sinusoidal signal to  $V_{CC}$  at  $f = 217\text{ Hz}$ .

**Table 8. Electrical characteristics at  $V_{CC} = +3.6\text{ V}$   
with  $GND = 0\text{ V}$ ,  $V_{icm} = 1.8\text{ V}$ ,  $T_{amb} = 25^\circ\text{C}$  (unless otherwise specified)<sup>(1)</sup>**

Symbol	Parameter	Min.	Typ.	Max.	Unit
$I_{CC}$	Supply current No input signal, no load		2	2.8	mA
$I_{STBY}$	Standby current <sup>(2)</sup> No input signal, $V_{STBY} = GND$		10	1000	nA
$V_{oo}$	Output offset voltage No input signal, $R_L = 8\ \Omega$		3	25	mV
$P_{out}$	Output power, $G = 6\text{ dB}$ THD = 1% max, $f = 1\text{ kHz}$ , $R_L = 4\ \Omega$ THD = 10% max, $f = 1\text{ kHz}$ , $R_L = 4\ \Omega$ THD = 1% max, $f = 1\text{ kHz}$ , $R_L = 8\ \Omega$ THD = 10% max, $f = 1\text{ kHz}$ , $R_L = 8\ \Omega$		1.1 1.4 0.7 0.85		W
THD + N	Total harmonic distortion + noise $P_{out} = 450\text{ mW}_{RMS}$ , $G = 6\text{ dB}$ , $20\text{ Hz} < f < 20\text{ kHz}$ $R_L = 8\ \Omega + 15\ \mu\text{H}$ , $BW < 30\text{ kHz}$ $P_{out} = 500\text{ mW}_{RMS}$ , $G = 6\text{ dB}$ , $f = 1\text{ kHz}$ $R_L = 8\ \Omega + 15\ \mu\text{H}$ , $BW < 30\text{ kHz}$		2 0.1		%
Efficiency	Efficiency $P_{out} = 1\text{ W}_{RMS}$ , $R_L = 4\ \Omega + \geq 15\ \mu\text{H}$ $P_{out} = 0.65\text{ W}_{RMS}$ , $R_L = 8\ \Omega + \geq 15\ \mu\text{H}$		78 88		%
PSRR	Power supply rejection ratio with inputs grounded <sup>(3)</sup> $f = 217\text{ Hz}$ , $R_L = 8\ \Omega$ , $G = 6\text{ dB}$ , $V_{ripple} = 200\text{ mV}_{pp}$		62		dB
CMRR	Common mode rejection ratio $f = 217\text{ Hz}$ , $R_L = 8\ \Omega$ , $G = 6\text{ dB}$ , $\Delta V_{ic} = 200\text{ mV}_{pp}$		56		dB
Gain	Gain value ( $R_{in}$ in $k\Omega$ )	$\frac{273k\Omega}{R_{in}}$	$\frac{300k\Omega}{R_{in}}$	$\frac{327k\Omega}{R_{in}}$	V/V
$R_{STBY}$	Internal resistance from standby to GND	273	300	327	$k\Omega$
$F_{PWM}$	Pulse width modulator base frequency	200	280	360	kHz
SNR	Signal to noise ratio (A-weighting) $P_{out} = 0.6\text{ W}$ , $R_L = 8\ \Omega$		83		dB
$t_{WU}$	Wake-up time		5	10	ms
$t_{STBY}$	Standby time		5	10	ms

**Table 8. Electrical characteristics at  $V_{CC} = +3.6\text{ V}$   
with  $GND = 0\text{ V}$ ,  $V_{icm} = 1.8\text{ V}$ ,  $T_{amb} = 25^\circ\text{C}$  (unless otherwise specified)<sup>(1)</sup>  
(continued)**

Symbol	Parameter	Min.	Typ.	Max.	Unit
$V_N$	Output voltage noise $f = 20\text{ Hz to } 20\text{ kHz}$ , $G = 6\text{ dB}$				
	Unweighted $R_L = 4\ \Omega$		83		$\mu\text{V}_{\text{RMS}}$
	A-weighted $R_L = 4\ \Omega$		57		
	Unweighted $R_L = 8\ \Omega$		83		
	A-weighted $R_L = 8\ \Omega$		61		
	Unweighted $R_L = 4\ \Omega + 15\ \mu\text{H}$		81		
	A-weighted $R_L = 4\ \Omega + 15\ \mu\text{H}$		58		
	Unweighted $R_L = 4\ \Omega + 30\ \mu\text{H}$		87		
	A-weighted $R_L = 4\ \Omega + 30\ \mu\text{H}$		62		
	Unweighted $R_L = 8\ \Omega + 30\ \mu\text{H}$		77		
	A-weighted $R_L = 8\ \Omega + 30\ \mu\text{H}$		56		
	Unweighted $R_L = 4\ \Omega + \text{filter}$		85		
	A-weighted $R_L = 4\ \Omega + \text{filter}$		63		
	Unweighted $R_L = 4\ \Omega + \text{filter}$		80		
A-weighted $R_L = 4\ \Omega + \text{filter}$		57			

1. All electrical values are guaranteed with correlation measurements at 2.5 V and 5 V.
2. Standby mode is activated when  $V_{\text{STBY}}$  is tied to GND.
3. Dynamic measurements -  $20 \cdot \log(\text{rms}(V_{\text{out}})/\text{rms}(V_{\text{ripple}}))$ .  $V_{\text{ripple}}$  is the superimposed sinusoidal signal to  $V_{CC}$  at  $f = 217\text{ Hz}$ .

**Table 9. Electrical characteristics at  $V_{CC} = +3.0\text{ V}$   
with  $GND = 0\text{ V}$ ,  $V_{icm} = 1.5\text{ V}$ ,  $T_{amb} = 25^\circ\text{C}$  (unless otherwise specified)<sup>(1)</sup>**

Symbol	Parameter	Min.	Typ.	Max.	Unit
$I_{CC}$	Supply current No input signal, no load		1.9	2.7	mA
$I_{STBY}$	Standby current <sup>(2)</sup> No input signal, $V_{STBY} = GND$		10	1000	nA
$V_{oo}$	Output offset voltage No input signal, $R_L = 8\ \Omega$		3	25	mV
$P_{out}$	Output power, $G = 6\text{ dB}$ THD = 1% max, $f = 1\text{ kHz}$ , $R_L = 4\ \Omega$ THD = 10% max, $f = 1\text{ kHz}$ , $R_L = 4\ \Omega$ THD = 1% max, $f = 1\text{ kHz}$ , $R_L = 8\ \Omega$ THD = 10% max, $f = 1\text{ kHz}$ , $R_L = 8\ \Omega$		0.7 1 0.5 0.6		W
THD + N	Total harmonic distortion + noise $P_{out} = 300\text{ mW}_{RMS}$ , $G = 6\text{ dB}$ , $20\text{ Hz} < f < 20\text{ kHz}$ $R_L = 8\ \Omega + 15\ \mu\text{H}$ , $BW < 30\text{ kHz}$ $P_{out} = 350\text{ mW}_{RMS}$ , $G = 6\text{ dB}$ , $f = 1\text{ kHz}$ $R_L = 8\ \Omega + 15\ \mu\text{H}$ , $BW < 30\text{ kHz}$		2 0.1		%
Efficiency	Efficiency $P_{out} = 0.7\text{ W}_{RMS}$ , $R_L = 4\ \Omega + \geq 15\ \mu\text{H}$ $P_{out} = 0.45\text{ W}_{RMS}$ , $R_L = 8\ \Omega + \geq 15\ \mu\text{H}$		78 88		%
PSRR	Power supply rejection ratio with inputs grounded <sup>(3)</sup> $f = 217\text{ Hz}$ , $R_L = 8\ \Omega$ , $G = 6\text{ dB}$ , $V_{ripple} = 200\text{ mV}_{pp}$		60		dB
CMRR	Common mode rejection ratio $f = 217\text{ Hz}$ , $R_L = 8\ \Omega$ , $G = 6\text{ dB}$ , $\Delta V_{ic} = 200\text{ mV}_{pp}$		54		dB
Gain	Gain value ( $R_{in}$ in $k\Omega$ )	$\frac{273k\Omega}{R_{in}}$	$\frac{300k\Omega}{R_{in}}$	$\frac{327k\Omega}{R_{in}}$	V/V
$R_{STBY}$	Internal resistance from standby to GND	273	300	327	$k\Omega$
$F_{PWM}$	Pulse width modulator base frequency	200	280	360	kHz
SNR	Signal to noise ratio (A-weighting) $P_{out} = 0.4\text{ W}$ , $R_L = 8\ \Omega$		82		dB
$t_{WU}$	Wake-up time		5	10	ms
$t_{STBY}$	Standby time		5	10	ms

**Table 9. Electrical characteristics at  $V_{CC} = +3.0\text{ V}$   
with  $GND = 0\text{ V}$ ,  $V_{icm} = 1.5\text{ V}$ ,  $T_{amb} = 25^\circ\text{C}$  (unless otherwise specified)<sup>(1)</sup>**  
(continued)

Symbol	Parameter	Min.	Typ.	Max.	Unit
$V_N$	Output voltage noise $f = 20\text{ Hz to } 20\text{ kHz}$ , $G = 6\text{ dB}$				
	Unweighted $R_L = 4\ \Omega$		83		$\mu\text{V}_{\text{RMS}}$
	A-weighted $R_L = 4\ \Omega$		57		
	Unweighted $R_L = 8\ \Omega$		83		
	A-weighted $R_L = 8\ \Omega$		61		
	Unweighted $R_L = 4\ \Omega + 15\ \mu\text{H}$		81		
	A-weighted $R_L = 4\ \Omega + 15\ \mu\text{H}$		58		
	Unweighted $R_L = 4\ \Omega + 30\ \mu\text{H}$		87		
	A-weighted $R_L = 4\ \Omega + 30\ \mu\text{H}$		62		
	Unweighted $R_L = 8\ \Omega + 30\ \mu\text{H}$		77		
	A-weighted $R_L = 8\ \Omega + 30\ \mu\text{H}$		56		
	Unweighted $R_L = 4\ \Omega + \text{filter}$		85		
	A-weighted $R_L = 4\ \Omega + \text{filter}$		63		
	Unweighted $R_L = 4\ \Omega + \text{filter}$		80		
A-weighted $R_L = 4\ \Omega + \text{filter}$		57			

1. All electrical values are guaranteed with correlation measurements at 2.5 V and 5 V.
2. Standby mode is active when  $V_{\text{STBY}}$  is tied to GND.
3. Dynamic measurements -  $20 \cdot \log(\text{rms}(V_{\text{out}})/\text{rms}(V_{\text{ripple}}))$ .  $V_{\text{ripple}}$  is the superimposed sinusoidal signal to  $V_{CC}$  at  $f = 217\text{ Hz}$ .

**Table 10. Electrical characteristics at  $V_{CC} = +2.5\text{ V}$   
with  $GND = 0\text{ V}$ ,  $V_{icm} = 1.25\text{ V}$ ,  $T_{amb} = 25^\circ\text{C}$  (unless otherwise specified)**

Symbol	Parameter	Min.	Typ.	Max.	Unit
$I_{CC}$	Supply current No input signal, no load		1.7	2.4	mA
$I_{STBY}$	Standby current <sup>(1)</sup> No input signal, $V_{STBY} = GND$		10	1000	nA
$V_{oo}$	Output offset voltage No input signal, $R_L = 8\ \Omega$		3	25	mV
$P_{out}$	Output power, $G = 6\text{ dB}$ THD = 1% max, $f = 1\text{ kHz}$ , $R_L = 4\ \Omega$ THD = 10% max, $f = 1\text{ kHz}$ , $R_L = 4\ \Omega$ THD = 1% max, $f = 1\text{ kHz}$ , $R_L = 8\ \Omega$ THD = 10% max, $f = 1\text{ kHz}$ , $R_L = 8\ \Omega$		0.5 0.65 0.33 0.41		W
THD + N	Total harmonic distortion + noise $P_{out} = 180\text{ mW}_{RMS}$ , $G = 6\text{ dB}$ , $20\text{ Hz} < f < 20\text{ kHz}$ $R_L = 8\ \Omega + 15\ \mu\text{H}$ , $BW < 30\text{ kHz}$ $P_{out} = 200\text{ mW}_{RMS}$ , $G = 6\text{ dB}$ , $f = 1\text{ kHz}$ $R_L = 8\ \Omega + 15\ \mu\text{H}$ , $BW < 30\text{ kHz}$		1 0.05		%
Efficiency	Efficiency $P_{out} = 0.47\text{ W}_{RMS}$ , $R_L = 4\ \Omega + 15\ \mu\text{H}$ $P_{out} = 0.3\text{ W}_{RMS}$ , $R_L = 8\ \Omega + 15\ \mu\text{H}$		78 88		%
PSRR	Power supply rejection ratio with inputs grounded <sup>(2)</sup> $f = 217\text{ Hz}$ , $R_L = 8\ \Omega$ , $G = 6\text{ dB}$ , $V_{ripple} = 200\text{ mV}_{pp}$		60		dB
CMRR	Common mode rejection ratio $f = 217\text{ Hz}$ , $R_L = 8\ \Omega$ , $G = 6\text{ dB}$ , $\Delta V_{ic} = 200\text{ mV}_{pp}$		54		dB
Gain	Gain value ( $R_{in}$ in $k\Omega$ )	$\frac{273k\Omega}{R_{in}}$	$\frac{300k\Omega}{R_{in}}$	$\frac{327k\Omega}{R_{in}}$	V/V
$R_{STBY}$	Internal resistance from standby to GND	273	300	327	$k\Omega$
$F_{PWM}$	Pulse width modulator base frequency	200	280	360	kHz
SNR	Signal to noise ratio (A-weighting) $P_{out} = 0.3\text{ W}$ , $R_L = 8\ \Omega$		80		dB
$t_{WU}$	Wake-up time		5	10	ms
$t_{STBY}$	Standby time		5	10	ms

**Table 10. Electrical characteristics at  $V_{CC} = +2.5\text{ V}$   
with  $GND = 0\text{ V}$ ,  $V_{icm} = 1.25\text{ V}$ ,  $T_{amb} = 25^\circ\text{C}$  (unless otherwise specified)  
(continued)**

Symbol	Parameter	Min.	Typ.	Max.	Unit
$V_N$	Output voltage noise $f = 20\text{ Hz to } 20\text{ kHz}$ , $G = 6\text{ dB}$				
	Unweighted $R_L = 4\ \Omega$		85		$\mu\text{V}_{\text{RMS}}$
	A-weighted $R_L = 4\ \Omega$		60		
	Unweighted $R_L = 8\ \Omega$		86		
	A-weighted $R_L = 8\ \Omega$		62		
	Unweighted $R_L = 4\ \Omega + 15\ \mu\text{H}$		76		
	A-weighted $R_L = 4\ \Omega + 15\ \mu\text{H}$		56		
	Unweighted $R_L = 4\ \Omega + 30\ \mu\text{H}$		82		
	A-weighted $R_L = 4\ \Omega + 30\ \mu\text{H}$		60		
	Unweighted $R_L = 8\ \Omega + 30\ \mu\text{H}$		67		
	A-weighted $R_L = 8\ \Omega + 30\ \mu\text{H}$		53		
	Unweighted $R_L = 4\ \Omega + \text{filter}$		78		
	A-weighted $R_L = 4\ \Omega + \text{filter}$		57		
	Unweighted $R_L = 4\ \Omega + \text{filter}$		74		
A-weighted $R_L = 4\ \Omega + \text{filter}$		54			

1. Standby mode is active when  $V_{\text{STBY}}$  is tied to GND.
2. Dynamic measurements -  $20 \cdot \log(\text{rms}(V_{\text{out}})/\text{rms}(V_{\text{ripple}}))$ .  $V_{\text{ripple}}$  is the superimposed sinusoidal signal to  $V_{CC}$  at  $f = 217\text{ Hz}$ .



**Table 11. Electrical characteristics at  $V_{CC} +2.4 V$   
with  $GND = 0 V$ ,  $V_{icm} = 1.2 V$ ,  $T_{amb} = 25^{\circ}C$  (unless otherwise specified)**

Symbol	Parameter	Min.	Typ.	Max.	Unit
$I_{CC}$	Supply current No input signal, no load		1.7		mA
$I_{STBY}$	Standby current <sup>(1)</sup> No input signal, $V_{STBY} = GND$		10		nA
$V_{oo}$	Output offset voltage No input signal, $R_L = 8 \Omega$		3		mV
$P_{out}$	Output power, $G = 6 dB$ THD = 1% max, $f = 1 kHz$ , $R_L = 4 \Omega$ THD = 10% max, $f = 1 kHz$ , $R_L = 4 \Omega$ THD = 1% max, $f = 1 kHz$ , $R_L = 8 \Omega$ THD = 10% max, $f = 1 kHz$ , $R_L = 8 \Omega$		0.42 0.61 0.3 0.38		W
THD + N	Total harmonic distortion + noise $P_{out} = 150 mW_{RMS}$ , $G = 6 dB$ , $20 Hz < f < 20 kHz$ $R_L = 8 \Omega + 15 \mu H$ , $BW < 30 kHz$		1		%
Efficiency	Efficiency $P_{out} = 0.38 W_{RMS}$ , $R_L = 4 \Omega + 3 15 \mu H$ $P_{out} = 0.25 W_{RMS}$ , $R_L = 8 \Omega + 3 15 \mu H$		77 86		%
CMRR	Common mode rejection ratio $f = 217 Hz$ , $R_L = 8 \Omega$ , $G = 6 dB$ , $\Delta V_{ic} = 200 mV_{pp}$		54		dB
Gain	Gain value ( $R_{in}$ in $k\Omega$ )	$\frac{273k\Omega}{R_{in}}$	$\frac{300k\Omega}{R_{in}}$	$\frac{327k\Omega}{R_{in}}$	V/V
$R_{STBY}$	Internal resistance from standby to GND	273	300	327	$k\Omega$
$F_{PWM}$	Pulse width modulator base frequency		280		kHz
SNR	Signal to noise ratio (A-weighting) $P_{out} = 0.25 W$ , $R_L = 8 \Omega$		80		dB
$t_{WU}$	Wake-up time		5		ms
$t_{STBY}$	Standby time		5		ms

**Table 11. Electrical characteristics at  $V_{CC} + 2.4\text{ V}$   
with  $GND = 0\text{ V}$ ,  $V_{icm} = 1.2\text{ V}$ ,  $T_{amb} = 25^\circ\text{C}$  (unless otherwise specified)  
(continued)**

Symbol	Parameter	Min.	Typ.	Max.	Unit
$V_N$	Output voltage noise $f = 20\text{ Hz to } 20\text{ kHz}$ , $G = 6\text{ dB}$				$\mu\text{V}_{\text{RMS}}$
	Unweighted $R_L = 4\ \Omega$		85		
	A-weighted $R_L = 4\ \Omega$		60		
	Unweighted $R_L = 8\ \Omega$		86		
	A-weighted $R_L = 8\ \Omega$		62		
	Unweighted $R_L = 4\ \Omega + 15\ \mu\text{H}$		76		
	A-weighted $R_L = 4\ \Omega + 15\ \mu\text{H}$		56		
	Unweighted $R_L = 4\ \Omega + 30\ \mu\text{H}$		82		
	A-weighted $R_L = 4\ \Omega + 30\ \mu\text{H}$		60		
	Unweighted $R_L = 8\ \Omega + 30\ \mu\text{H}$		67		
	A-weighted $R_L = 8\ \Omega + 30\ \mu\text{H}$		53		
	Unweighted $R_L = 4\ \Omega + \text{filter}$		78		
	A-weighted $R_L = 4\ \Omega + \text{filter}$		57		
	Unweighted $R_L = 4\ \Omega + \text{filter}$		74		
A-weighted $R_L = 4\ \Omega + \text{filter}$		54			

1. Standby mode is active when  $V_{\text{STBY}}$  is tied to GND.

### 3.1 Electrical characteristics curves

The graphs shown in this section use the following abbreviations.

- $R_L + 15 \mu\text{H}$  or  $30 \mu\text{H}$  = pure resistor + very low series resistance inductor
- Filter = LC output filter ( $1 \mu\text{F} + 30 \mu\text{H}$  for  $4 \Omega$  and  $0.5 \mu\text{F} + 60 \mu\text{H}$  for  $8 \Omega$ )

All measurements are done with  $C_{S1} = 1 \mu\text{F}$  and  $C_{S2} = 100 \text{ nF}$  (see [Figure 2](#)), except for the PSRR where  $C_{S1}$  is removed (see [Figure 3](#)).

**Figure 2. Schematic used for test measurements**

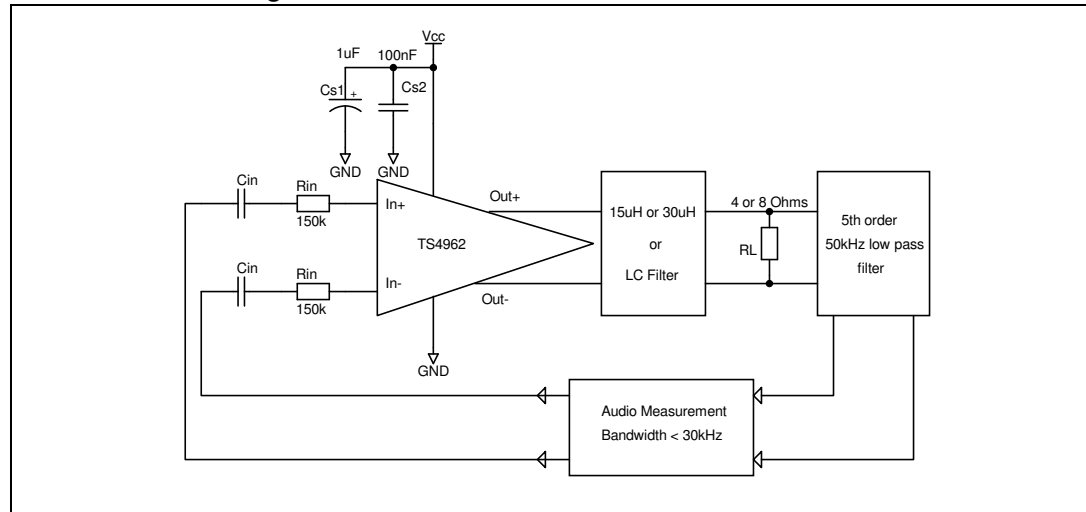

**Figure 3. Schematic used for PSRR measurements**

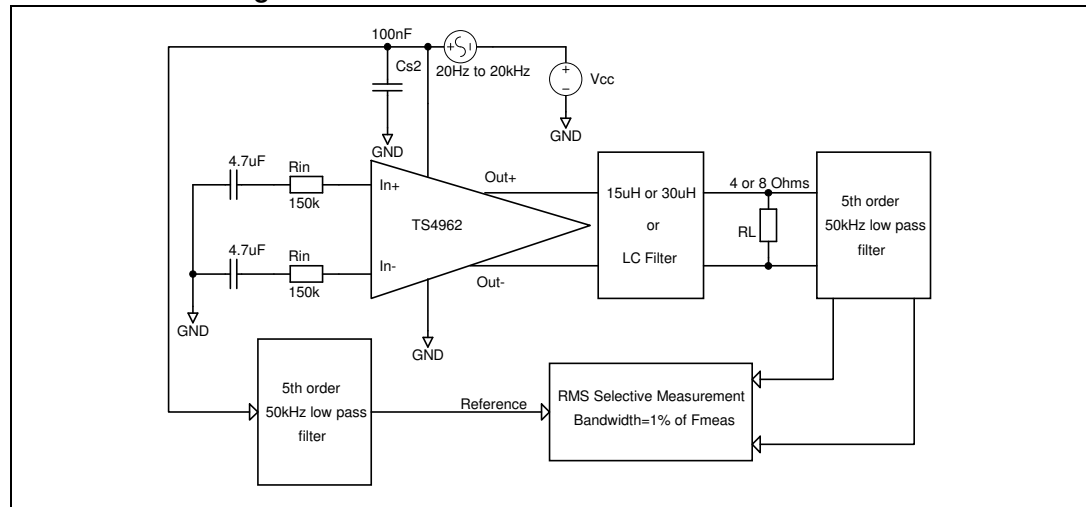

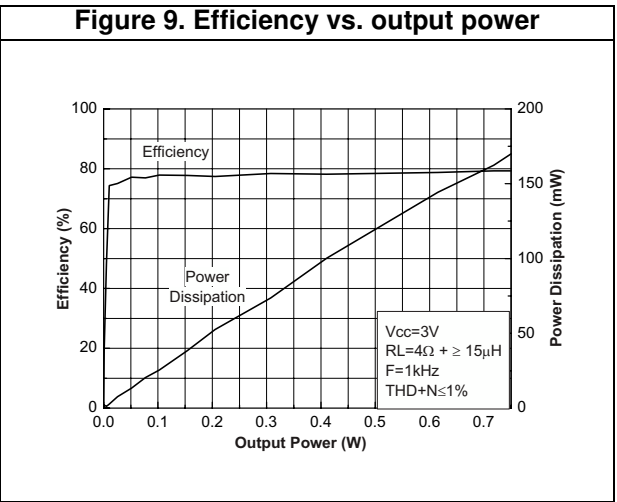
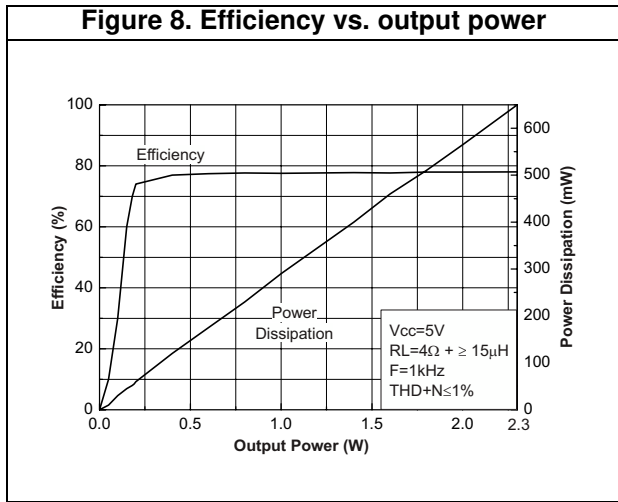
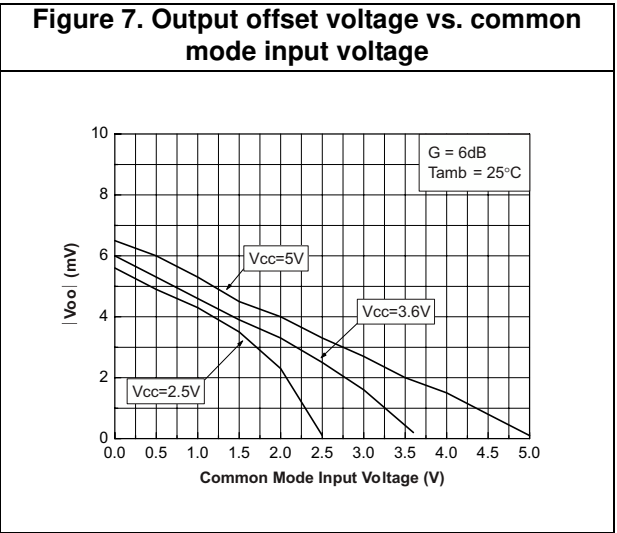
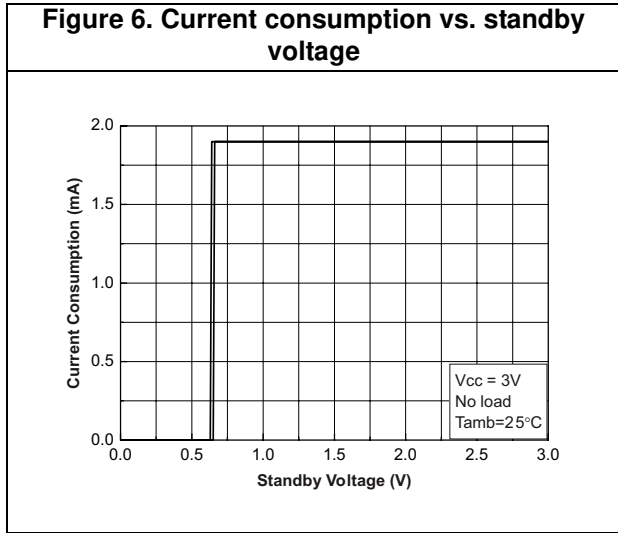
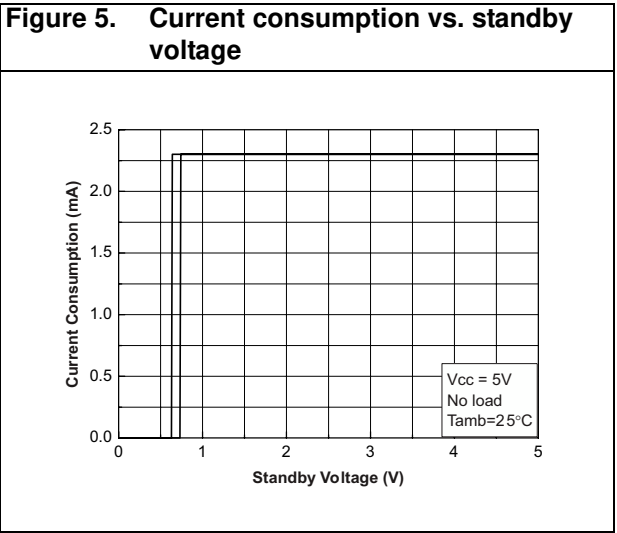
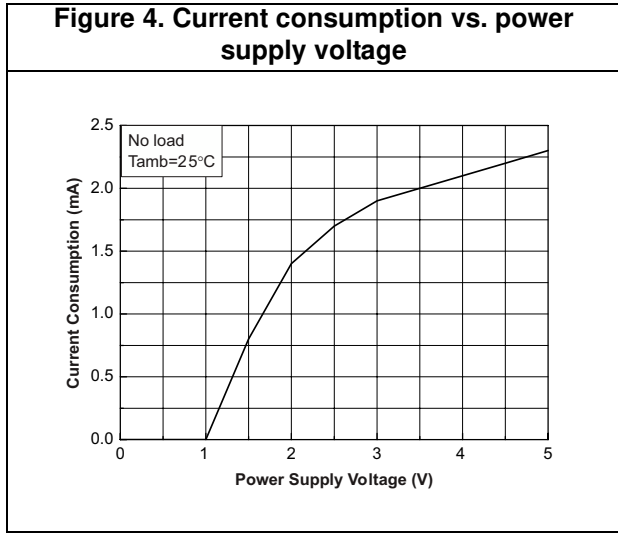

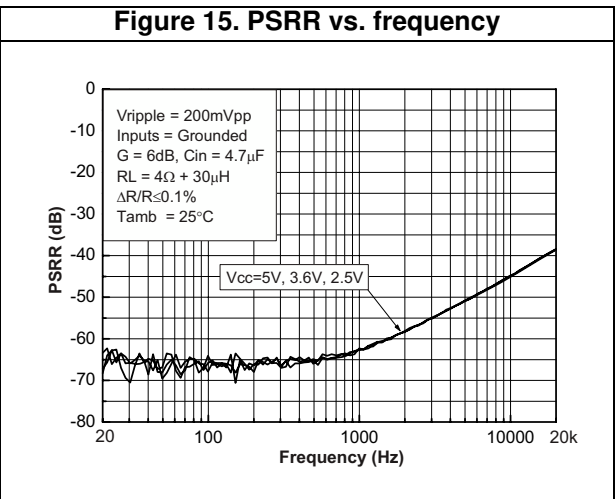
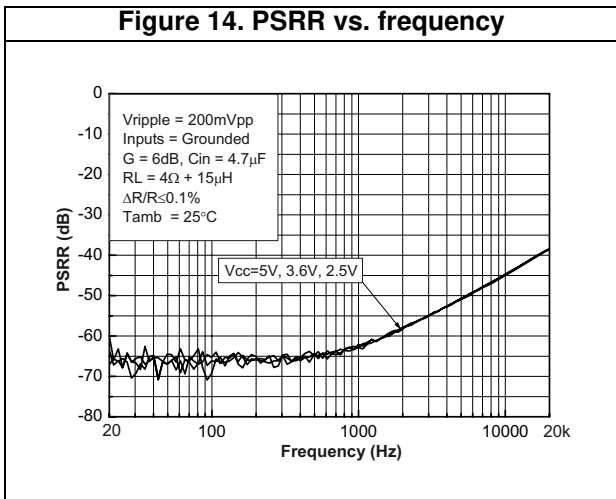
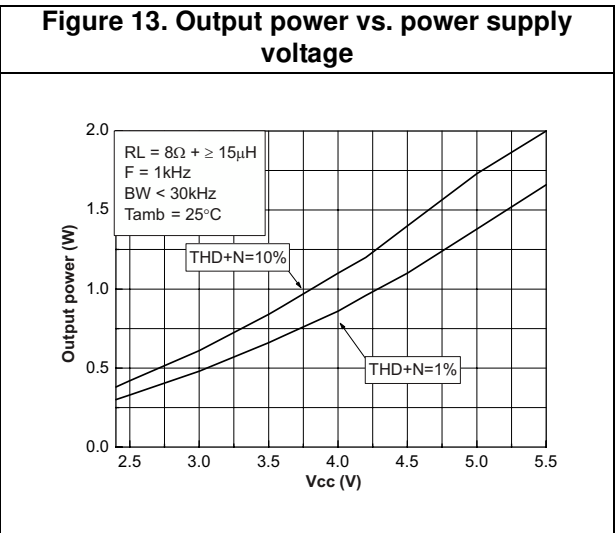
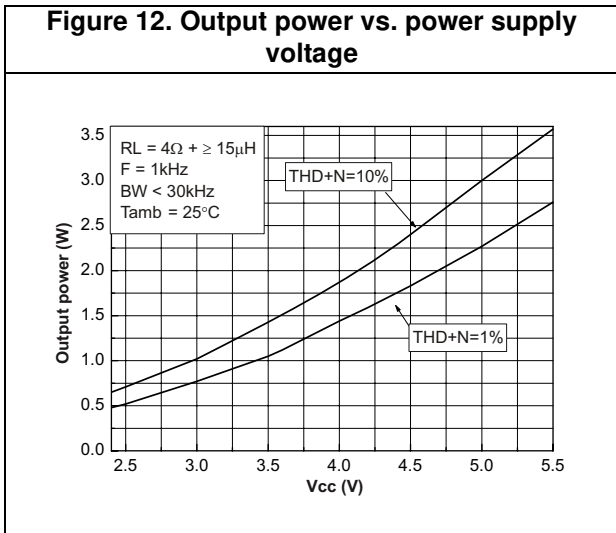
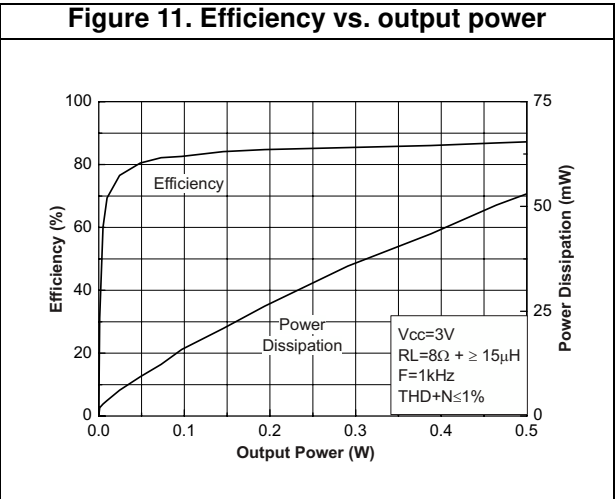
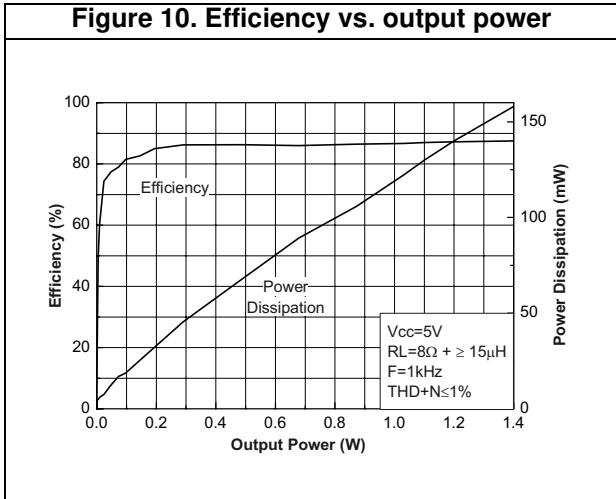

Figure 16. PSRR vs. frequency

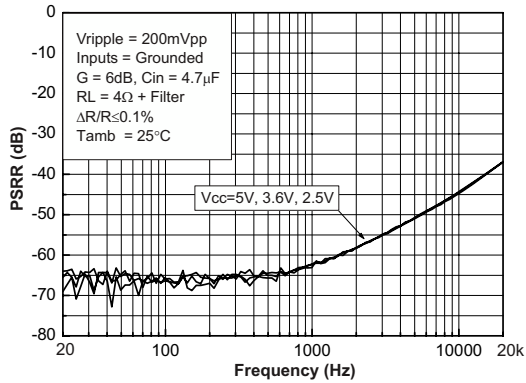

Figure 17. PSRR vs. frequency

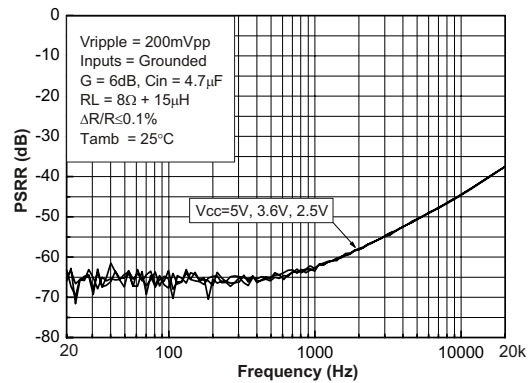

Figure 18. PSRR vs. frequency

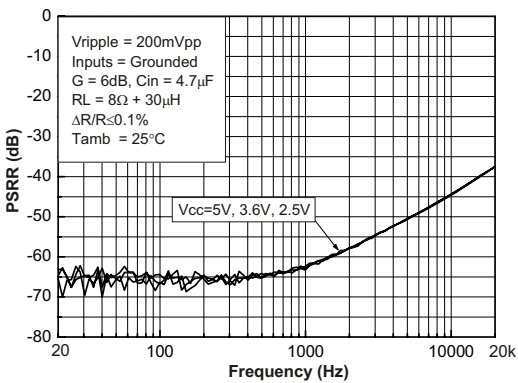

Figure 19. PSRR vs. frequency

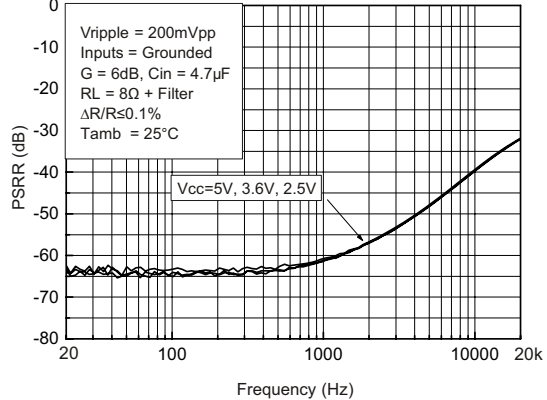

Figure 20. PSRR vs. common mode input voltage

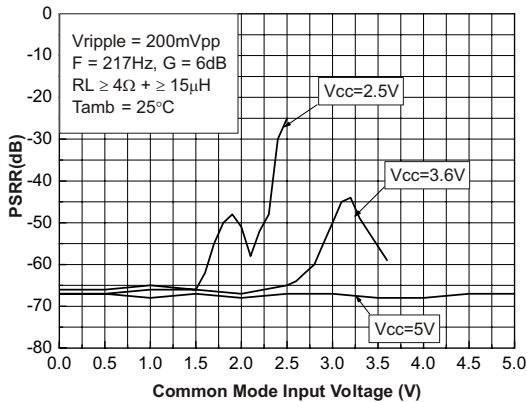

Figure 21. CMRR vs. frequency

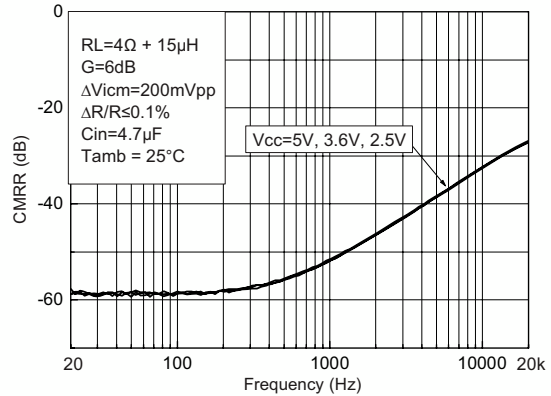

Figure 22. CMRR vs. frequency

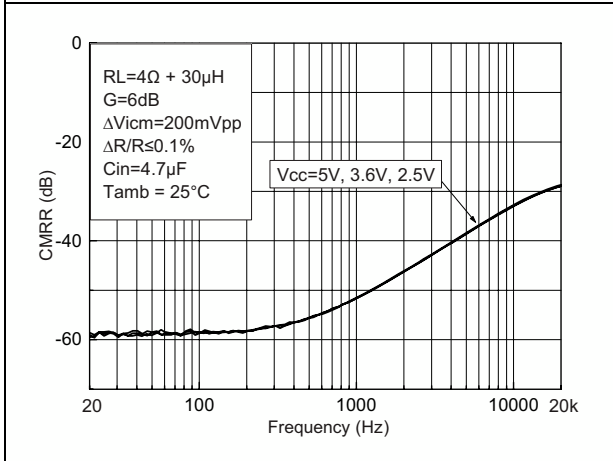

Figure 23. CMRR vs. frequency

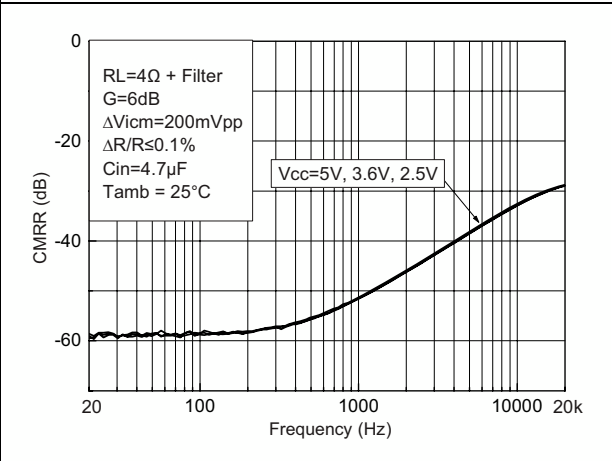

Figure 24. CMRR vs. frequency

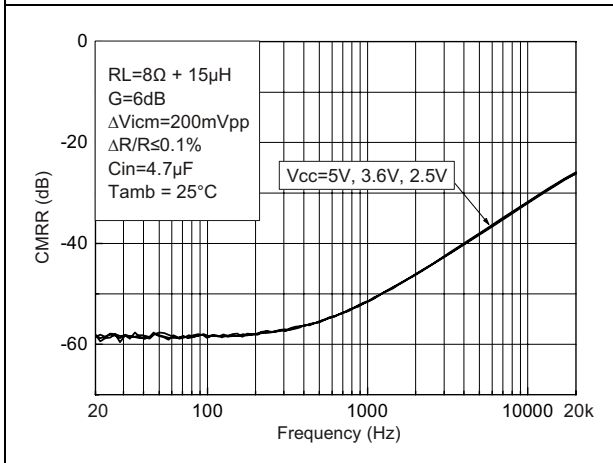

Figure 25. CMRR vs. frequency

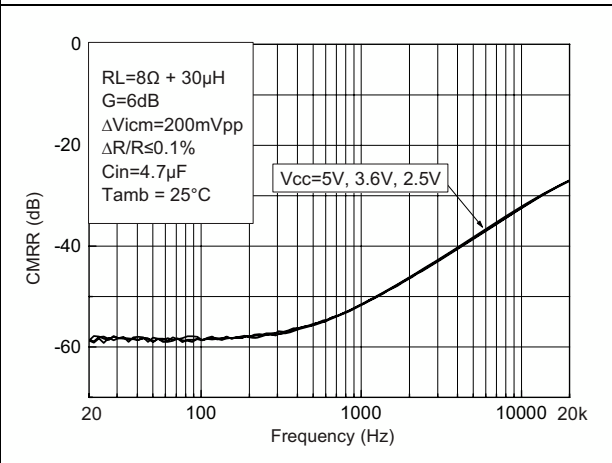

Figure 26. CMRR vs. frequency

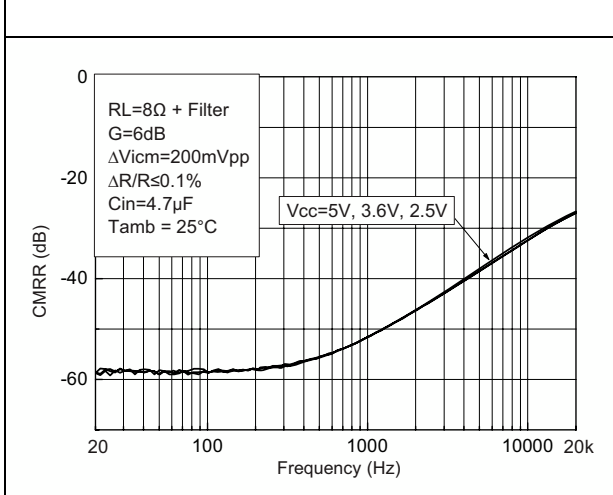
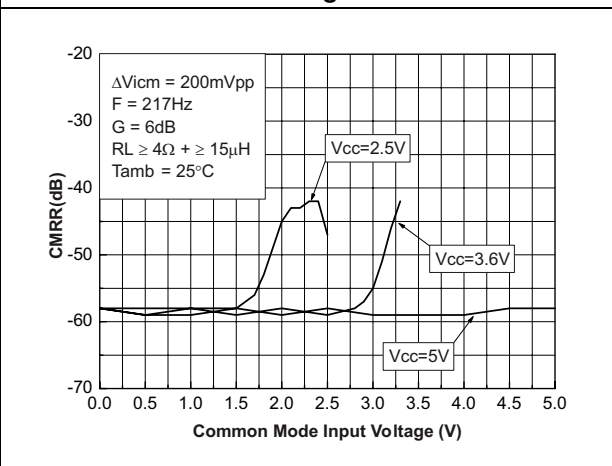

Figure 27. CMRR vs. common mode input voltage



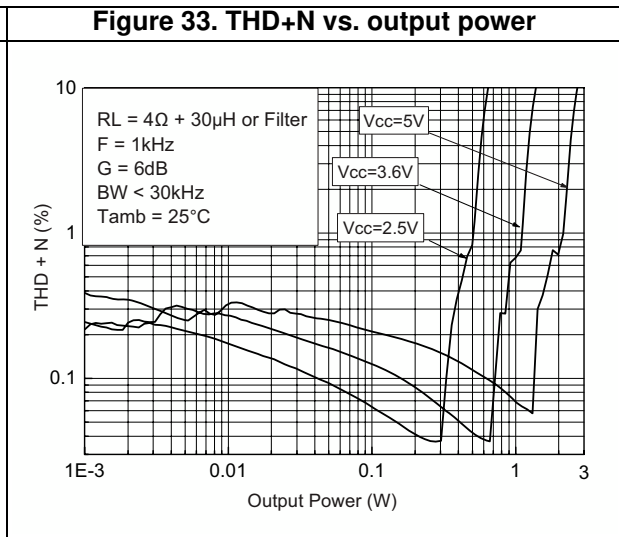
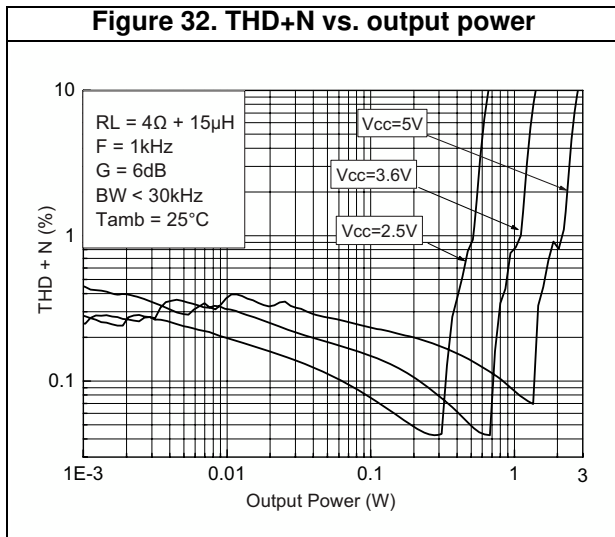
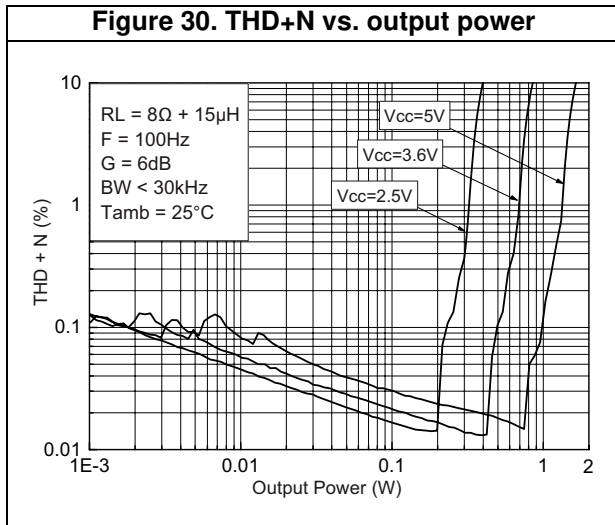
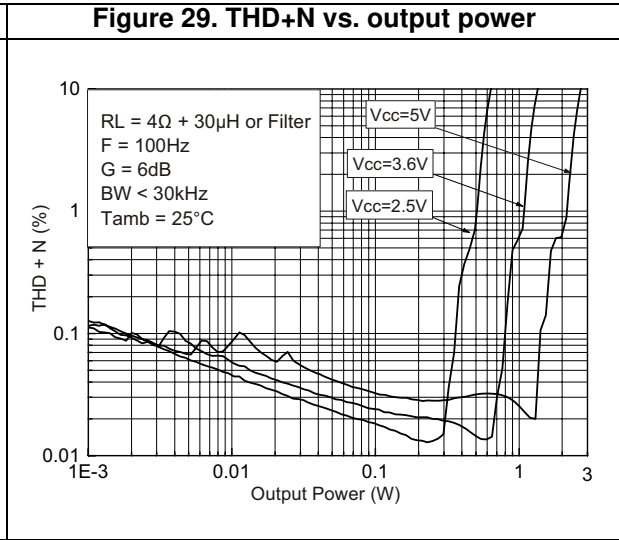
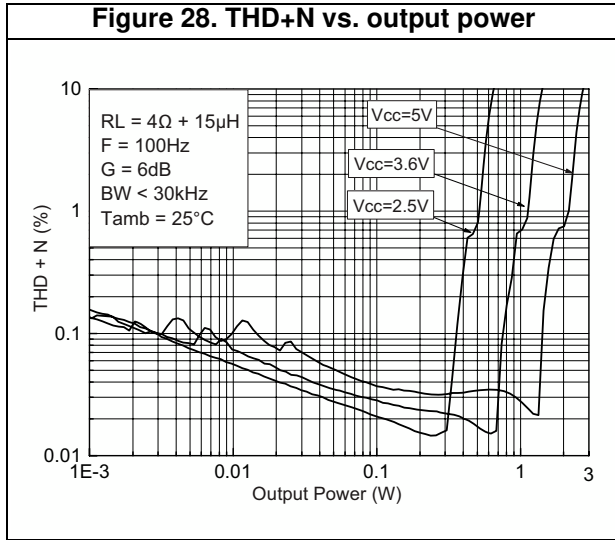



Figure 34. THD+N vs. output power

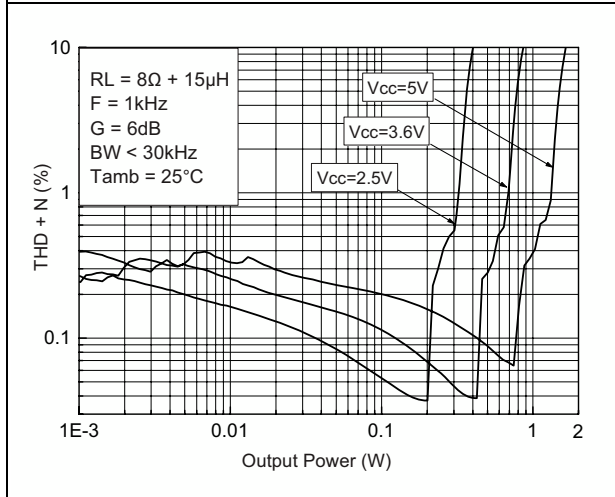

Figure 35. THD+N vs. output power

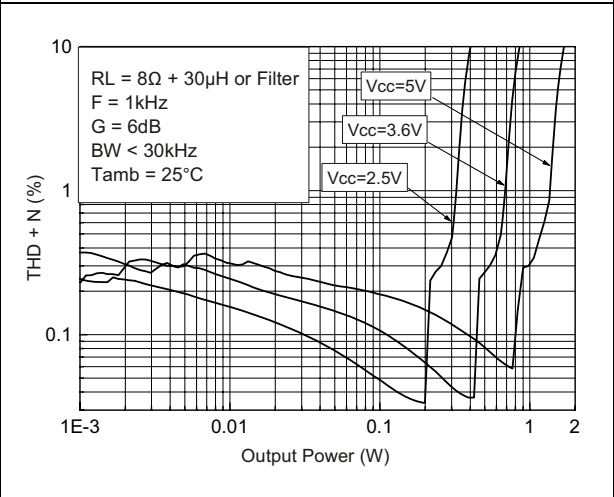

Figure 36. THD+N vs. frequency

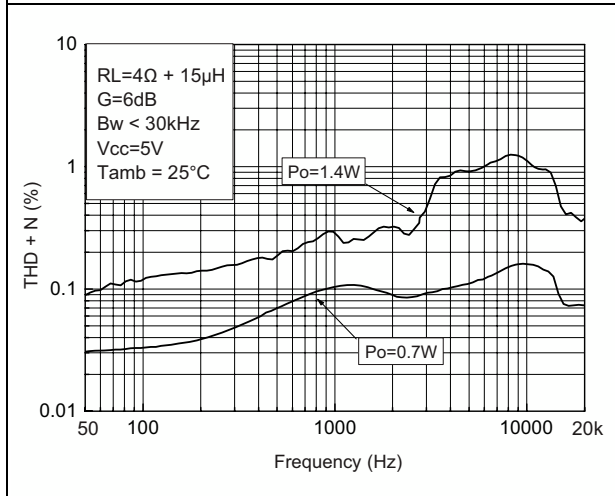

Figure 37. THD+N vs. frequency

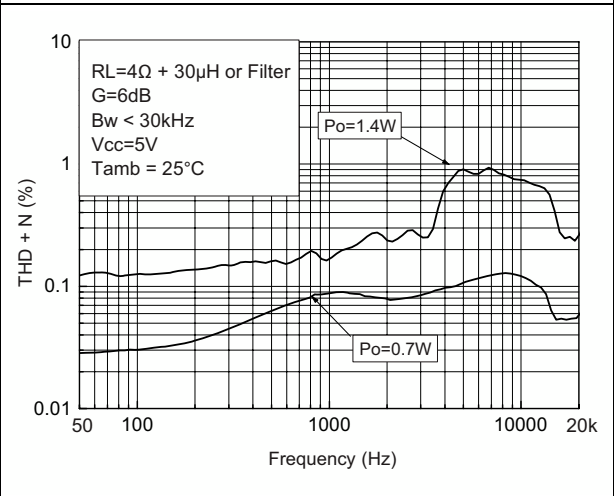

Figure 38. THD+N vs. frequency

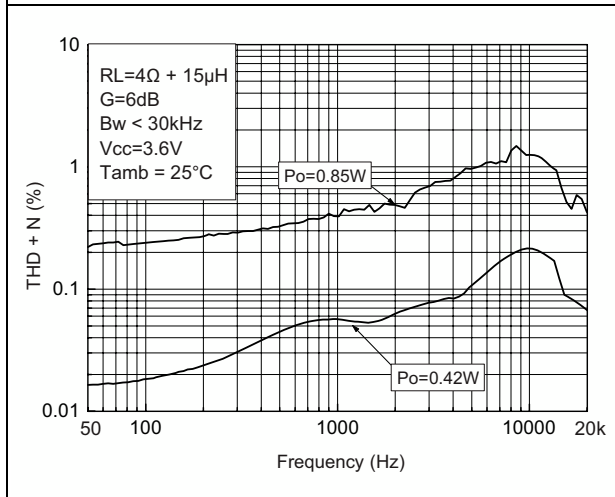
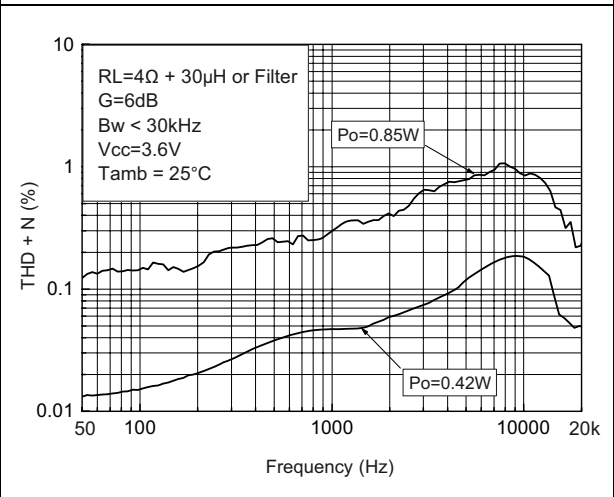
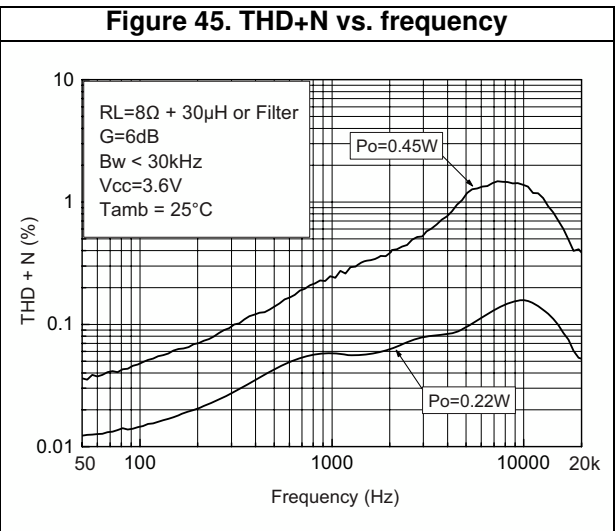
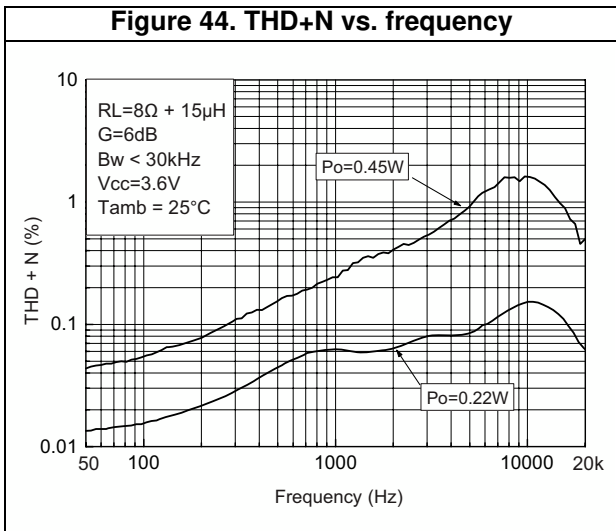
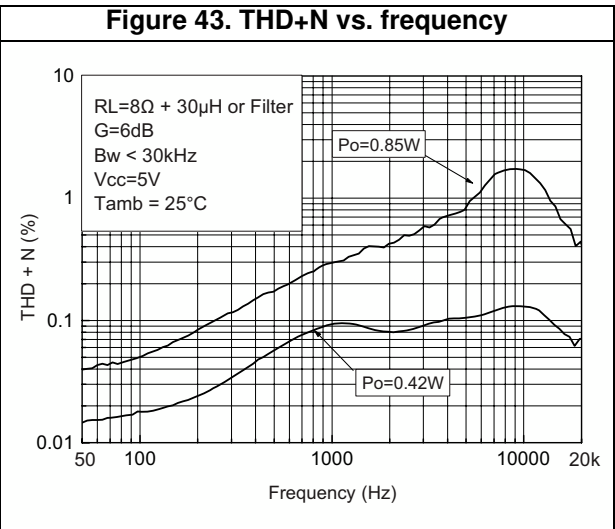
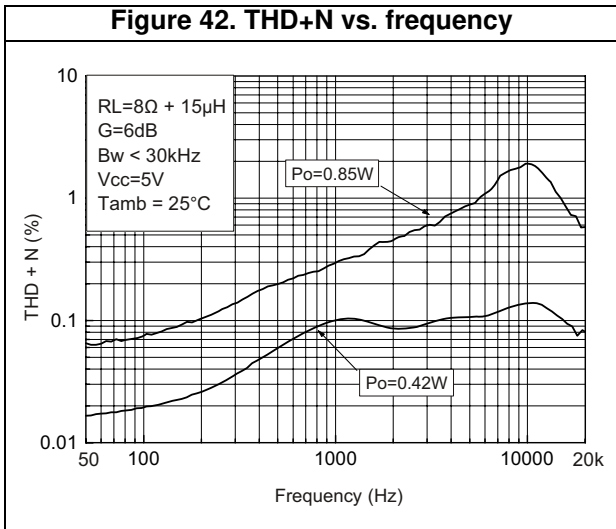
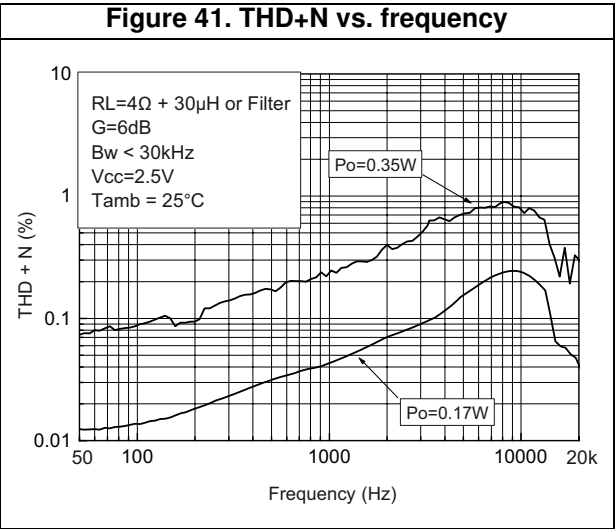
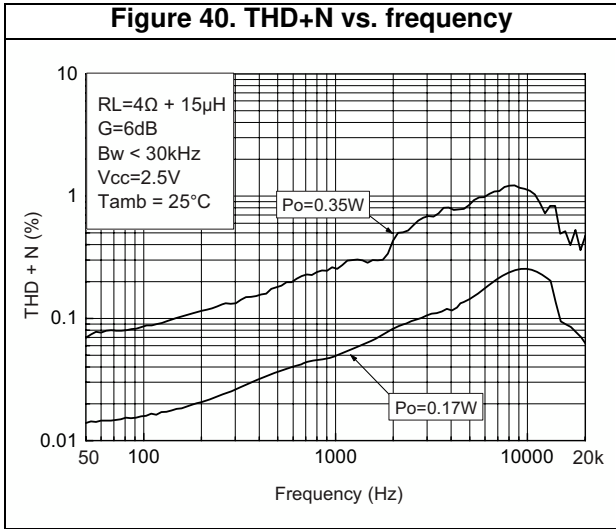

Figure 39. THD+N vs. frequency





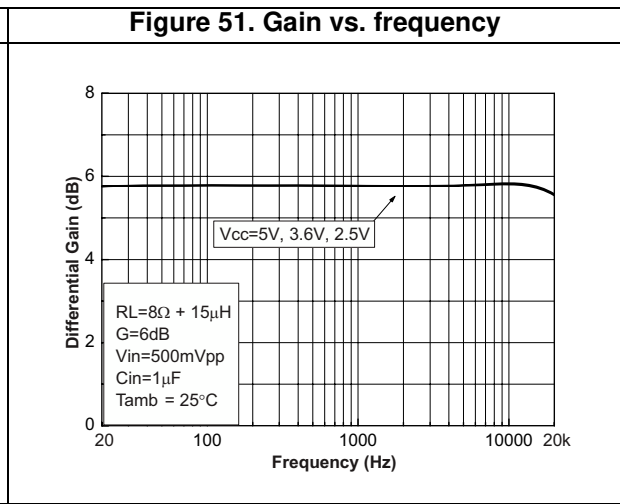
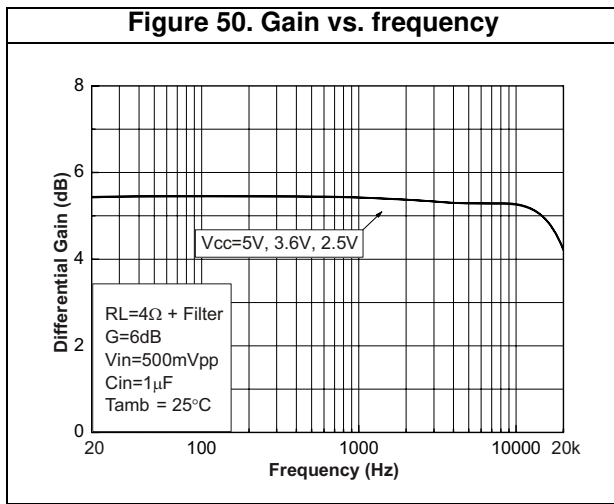
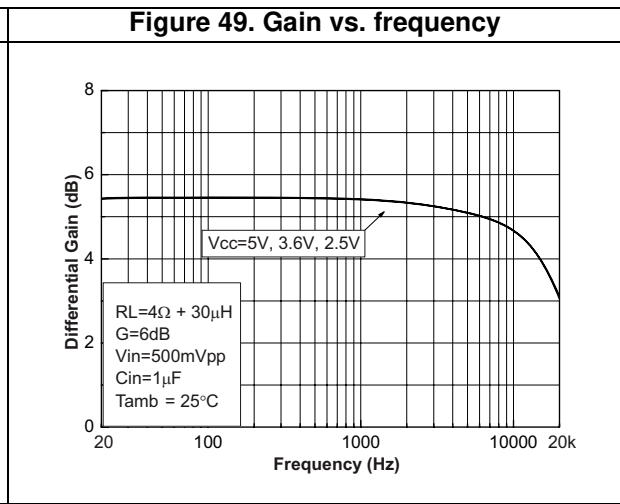
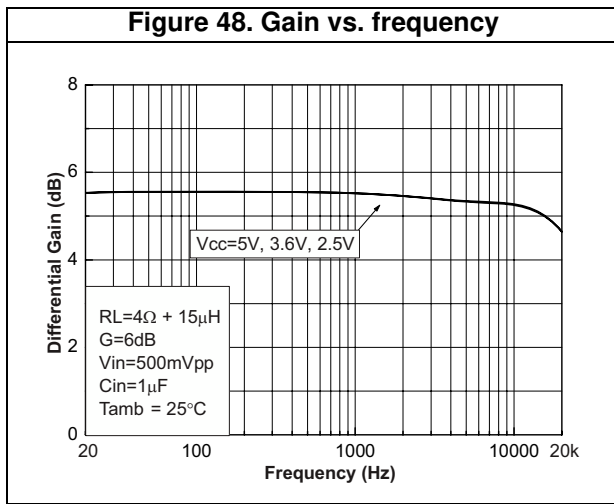
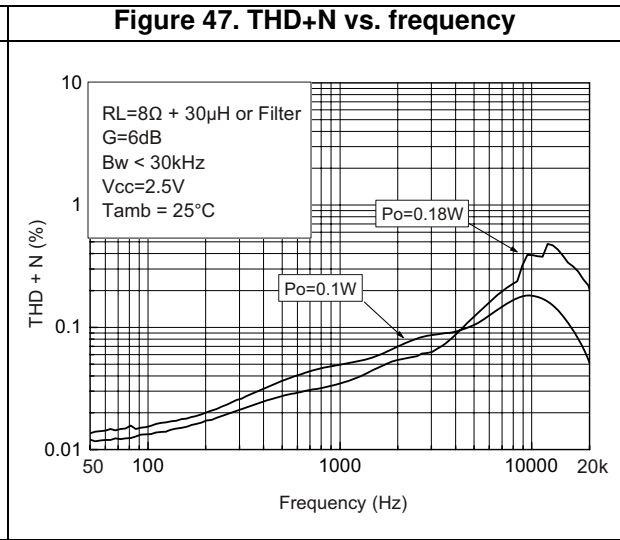
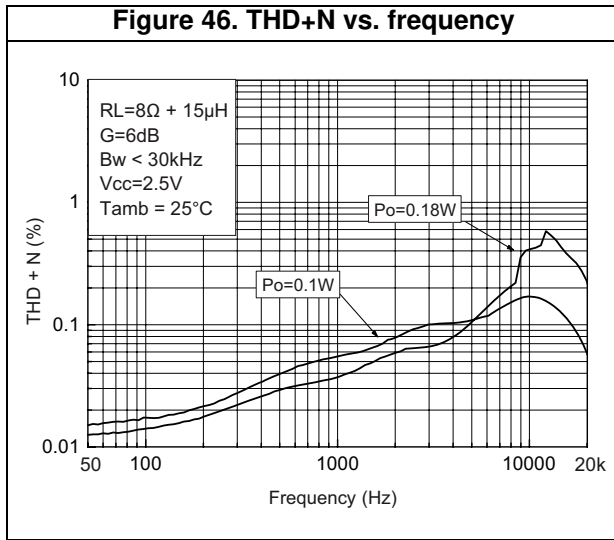

Figure 52. Gain vs. frequency

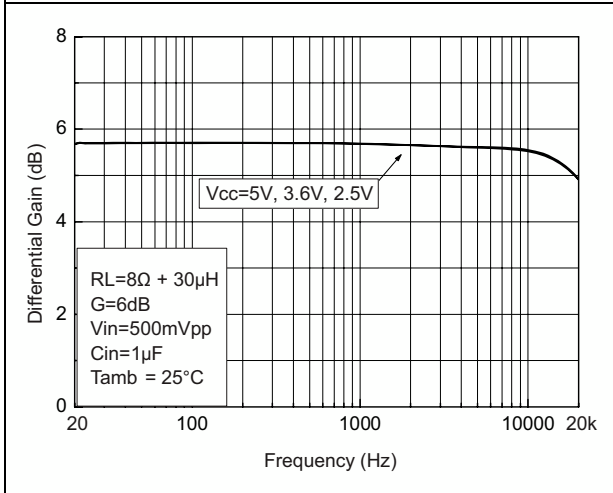

Figure 53. Gain vs. frequency

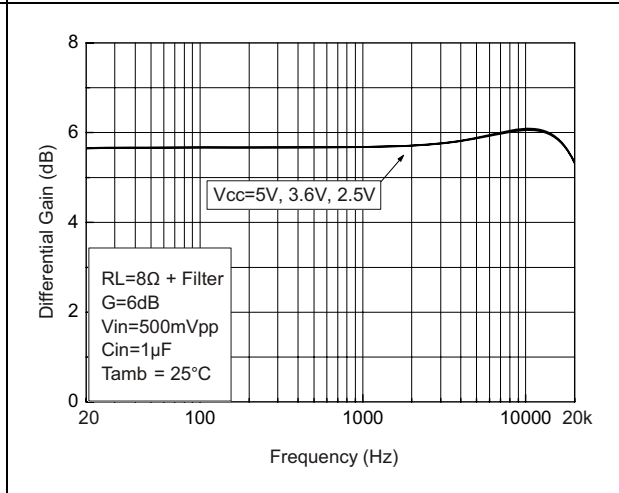

Figure 54. Gain vs. frequency

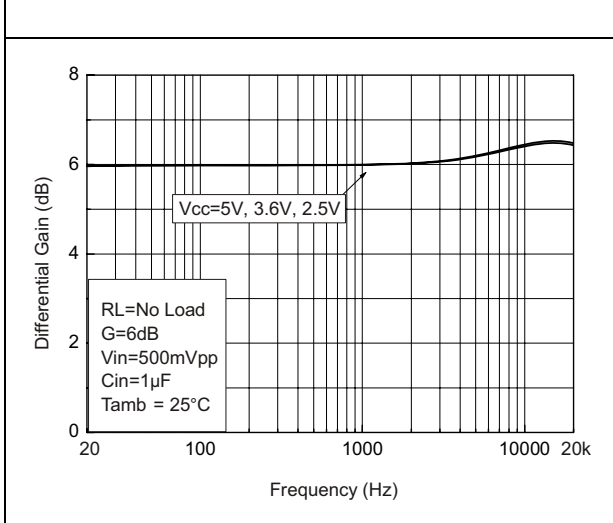

Figure 55. Startup and shutdown times  
 $V_{CC} = 5V, G = 6dB, C_{in} = 1\mu F$  (5ms/div)

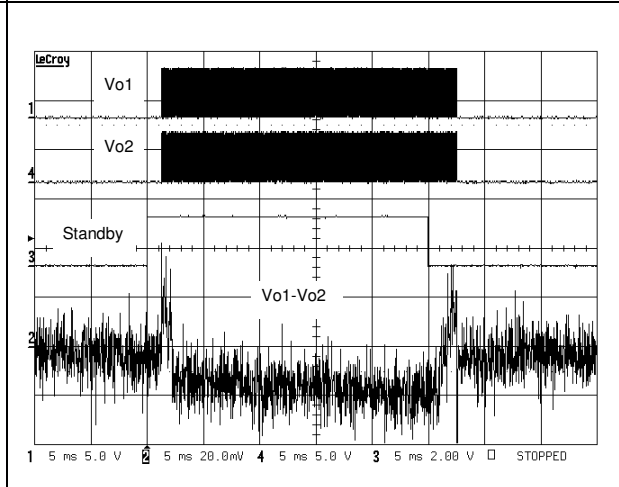

Figure 56. Startup and shutdown times  
 $V_{CC} = 3V, G = 6dB, C_{in} = 1\mu F$  (5ms/div)

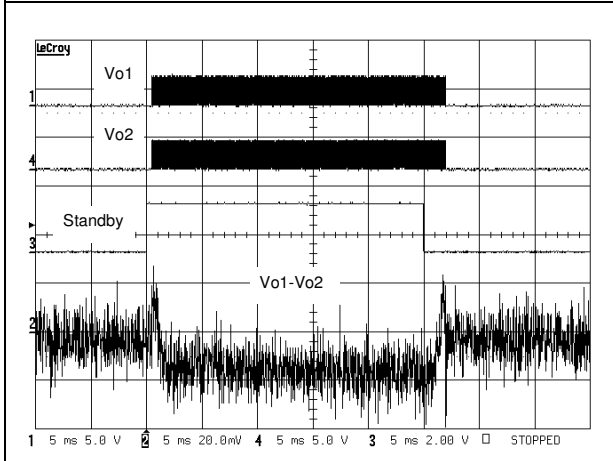
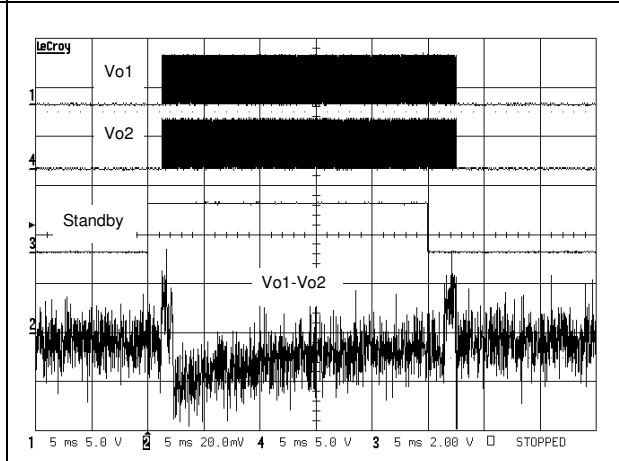
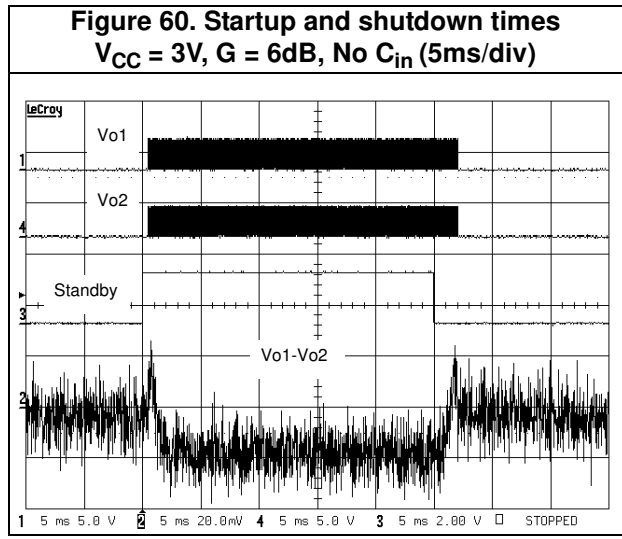
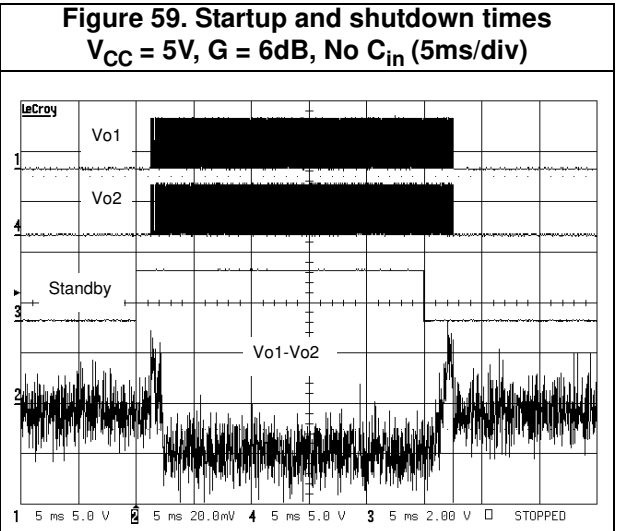
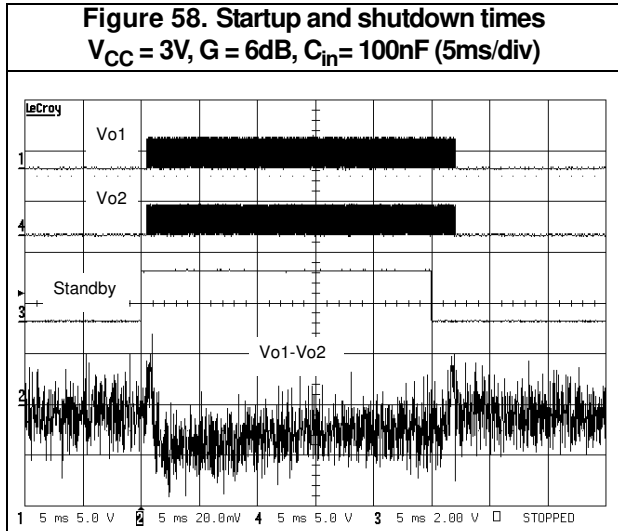

Figure 57. Startup and shutdown times  
 $V_{CC} = 5V, G = 6dB, C_{in} = 100nF$  (5ms/div)





## 4 Application information

### 4.1 Differential configuration principle

The TS4962 is a monolithic, fully differential input/output class D power amplifier. The TS4962 also includes a common-mode feedback loop that controls the output bias value to average it at  $V_{CC}/2$  for any DC common-mode input voltage. This allows the device to always have a maximum output voltage swing, and by consequence, maximize the output power. Moreover, as the load is connected differentially compared to a single-ended topology, the output is four times higher for the same power supply voltage.

The advantages of a fully differential amplifier are:

- high PSRR (power supply rejection ratio).
- high common mode noise rejection.
- virtually zero pop without additional circuitry, giving a faster start-up time compared to conventional single-ended input amplifiers.
- easier interfacing with differential output audio DAC.
- no input coupling capacitors required because of common-mode feedback loop.

The main disadvantage is that, since the differential function is directly linked to the external resistor mismatching, particular attention should be paid to this mismatching in order to obtain the best performance from the amplifier.

### 4.2 Gain in typical application schematic

Typical differential applications are shown in [Figure 1 on page 6](#).

In the flat region of the frequency-response curve (no input coupling capacitor effect), the differential gain is expressed by the relation:

$$A_{V_{diff}} = \frac{Out^+ - Out^-}{In^+ - In^-} = \frac{300}{R_{in}}$$

with  $R_{in}$  expressed in  $k\Omega$ .

Due to the tolerance of the internal  $150\text{ k}\Omega$  feedback resistor, the differential gain is in the range (no tolerance on  $R_{in}$ ):

$$\frac{273}{R_{in}} \leq A_{V_{diff}} \leq \frac{327}{R_{in}}$$

### 4.3 Common-mode feedback loop limitations

As explained previously, the common-mode feedback loop allows the output DC bias voltage to be averaged at  $V_{CC}/2$  for any DC common-mode bias input voltage.

However, due to a  $V_{icm}$  limitation in the input stage (see [Table 3: Operating conditions on page 4](#)), the common-mode feedback loop can play its role only within a defined range. This range depends upon the values of  $V_{CC}$  and  $R_{in}$  ( $A_{Vdiff}$ ). To have a good estimation of the  $V_{icm}$  value, we can apply this formula (no tolerance on  $R_{in}$ ):

$$V_{icm} = \frac{V_{CC} \times R_{in} + 2 \times V_{IC} \times 150k\Omega}{2 \times (R_{in} + 150k\Omega)} \quad (V)$$

with

$$V_{IC} = \frac{In^+ + In^-}{2} \quad (V)$$

And the result of the calculation must be in the range:

$$0.5V \leq V_{icm} \leq V_{CC} - 0.8V$$

Due to the +/-9% tolerance on the 150 kΩ resistor, it is also important to check  $V_{icm}$  in these conditions.

$$\frac{V_{CC} \times R_{in} + 2 \times V_{IC} \times 136.5k\Omega}{2 \times (R_{in} + 136.5k\Omega)} \leq V_{icm} \leq \frac{V_{CC} \times R_{in} + 2 \times V_{IC} \times 163.5k\Omega}{2 \times (R_{in} + 163.5k\Omega)}$$

If the result of the  $V_{icm}$  calculation is not in the previous range, input coupling capacitors must be used. With  $V_{CC}$  between 2.4 and 2.5 V, input coupling capacitors are mandatory.

#### For example:

With  $V_{CC} = 3$  V,  $R_{in} = 150$  k and  $V_{IC} = 2.5$  V, we typically find  $V_{icm} = 2$  V, which is lower than  $3$  V -  $0.8$  V =  $2.2$  V. With  $136.5$  kΩ we find  $1.97$  V and with  $163.5$  kΩ we have  $2.02$  V. Therefore, no input coupling capacitors are required.

### 4.4 Low frequency response

If a low frequency bandwidth limitation is requested, it is possible to use input coupling capacitors.

In the low frequency region,  $C_{in}$  (input coupling capacitor) starts to have an effect.  $C_{in}$  forms, with  $R_{in}$ , a first order high-pass filter with a -3 dB cut-off frequency.

$$F_{CL} = \frac{1}{2\pi \times R_{in} \times C_{in}} \quad (Hz)$$

So, for a desired cut-off frequency we can calculate  $C_{in}$ ,

$$C_{in} = \frac{1}{2\pi \times R_{in} \times F_{CL}} \quad (F)$$

with  $R_{in}$  in Ω and  $F_{CL}$  in Hz.

## 4.5 Decoupling of the circuit

A power supply capacitor, referred to as  $C_S$ , is needed to correctly bypass the TS4962.

The TS4962 has a typical switching frequency at 250 kHz and output fall and rise time about 5 ns. Due to these very fast transients, careful decoupling is mandatory.

A 1  $\mu$ F ceramic capacitor is enough, but it must be located very close to the TS4962 in order to avoid any extra parasitic inductance being created by an overly long track wire. In relation with  $dI/dt$ , this parasitic inductance introduces an overvoltage that decreases the global efficiency and, if it is too high, may cause a breakdown of the device.

In addition, even if a ceramic capacitor has an adequate high frequency ESR value, its current capability is also important. A 0603 size is a good compromise, particularly when a 4  $\Omega$  load is used.

Another important parameter is the rated voltage of the capacitor. A 1  $\mu$ F/6.3 V capacitor used at 5 V loses about 50% of its value. In fact, with a 5 V power supply voltage, the decoupling value is about 0.5  $\mu$ F instead of 1  $\mu$ F. As  $C_S$  has particular influence on the THD+N in the medium-high frequency region, this capacitor variation becomes decisive. In addition, less decoupling means higher overshoots, which can be problematic if they reach the power supply AMR value (6 V).

## 4.6 Wake-up time ( $t_{WU}$ )

When the standby is released to set the device ON, there is a wait of about 5 ms. The TS4962 has an internal digital delay that mutes the outputs and releases them after this time in order to avoid any pop noise.

## 4.7 Shutdown time ( $t_{STBY}$ )

When the standby command is set, the time required to put the two output stages into high impedance and to put the internal circuitry in standby mode is about 5 ms. This time is used to decrease the gain and avoid any pop noise during the shutdown phase.

## 4.8 Consumption in standby mode

Between the standby pin and GND there is an internal 300 k $\Omega$  resistor. This resistor forces the TS4962 to be in standby mode when the standby input pin is left floating.

However, this resistor also introduces additional power consumption if the standby pin voltage is not 0 V.

For example, with a 0.4 V standby voltage pin, [Table 3 on page 4](#) shows that you must add  $0.4 \text{ V}/300 \text{ k}\Omega = 1.3 \text{ }\mu\text{A}$  typical ( $0.4 \text{ V}/273 \text{ k}\Omega = 1.46 \text{ }\mu\text{A}$  maximum) to the standby current specified in [Table 5 on page 5](#).



### 4.9 Single-ended input configuration

It is possible to use the TS4962 in a single-ended input configuration. However, input coupling capacitors are needed in this configuration. *Figure 61* shows a typical single-ended input application.

**Figure 61. Single-ended input typical application**

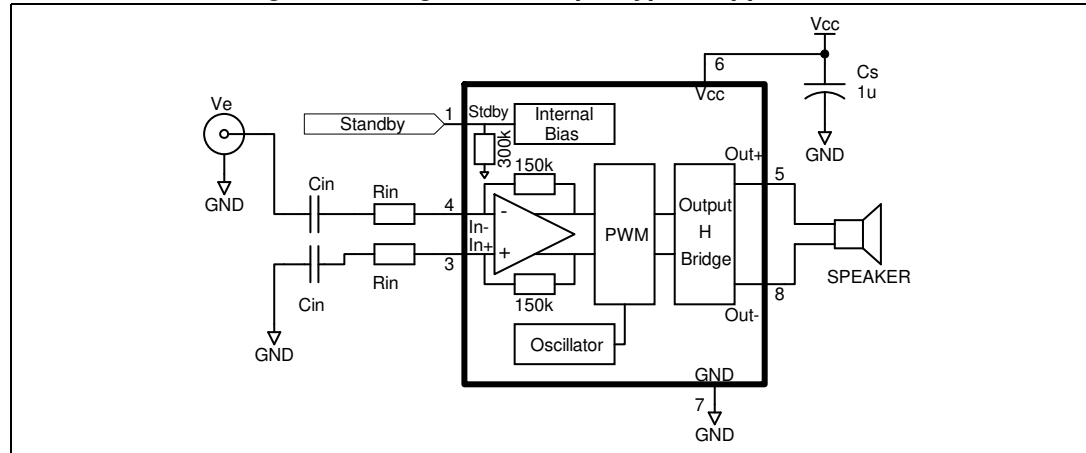

All formulas are identical except for the gain with  $R_{in}$  in  $k\Omega$ .

$$A_{V_{single}} = \frac{V_e}{Out^+ - Out^-} = \frac{300}{R_{in}}$$

Due to the internal resistor tolerance we have:

$$\frac{273}{R_{in}} \leq A_{V_{single}} \leq \frac{327}{R_{in}}$$

In the event that multiple single-ended inputs are summed, it is important that the impedance on both TS4962 inputs ( $In^-$  and  $In^+$ ) be equal.

**Figure 62. Typical application schematic with multiple single-ended inputs**

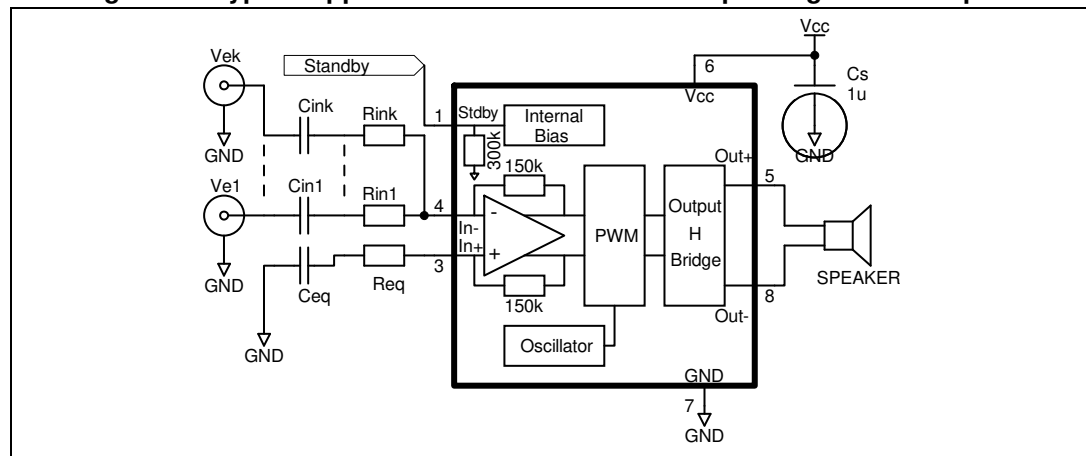

We have the following equations.

$$\text{Out}^+ - \text{Out}^- = V_{e1} \times \frac{300}{R_{in1}} + \dots + V_{ek} \times \frac{300}{R_{ink}} \quad (V)$$

$$C_{eq} = \sum_{j=1}^k C_{ini}$$

$$C_{ini} = \frac{1}{2 \times \pi \times R_{ini} \times F_{CLi}} \quad (F)$$

$$R_{eq} = \frac{1}{\sum_{j=1}^k \frac{1}{R_{ini}}}$$

In general, for mixed situations (single-ended and differential inputs) it is best to use the same rule, that is, equalize impedance on both TS4962 inputs.

## 4.10 Output filter considerations

The TS4962 is designed to operate without an output filter. However, due to very sharp transients on the TS4962 output, EMI-radiated emissions may cause some standard compliance issues.

These EMI standard compliance issues can appear if the distance between the TS4962 outputs and the loudspeaker terminal is long (typically more than 50 mm, or 100 mm in both directions, to the speaker terminals). As the PCB layout and internal equipment device are different for each configuration, it is difficult to provide a one-size-fits-all solution.

However, to decrease the probability of EMI issues, there are several simple rules to follow.

- Reduce, as much as possible, the distance between the TS4962 output pins and the speaker terminals.
- Use ground planes for "shielding" sensitive wires.
- Place, as close as possible to the TS4962 and in series with each output, a ferrite bead with a rated current of at least 2.5 A and an impedance greater than 50  $\Omega$  at frequencies above 30 MHz. If, after testing, these ferrite beads are not necessary, replace them by a short-circuit.
- Allow enough footprint to place, if necessary, a capacitor to short perturbations to ground (see [Figure 63](#)).

**Figure 63. Method for shorting perturbations to ground**

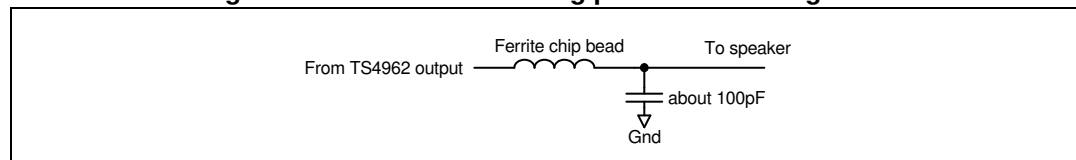

In the case where the distance between the TS4962 output and the speaker terminals is high, it is possible to observe low frequency EMI issues due to the fact that the typical operating frequency is 250 kHz. In this configuration, we recommend using an output filter (as represented in [Figure 1 on page 6](#)). It should be placed as close as possible to the device.

## 4.11 Several examples with summed inputs

### 4.11.1 Example 1: dual differential inputs

Figure 64. Typical application schematic with dual differential inputs

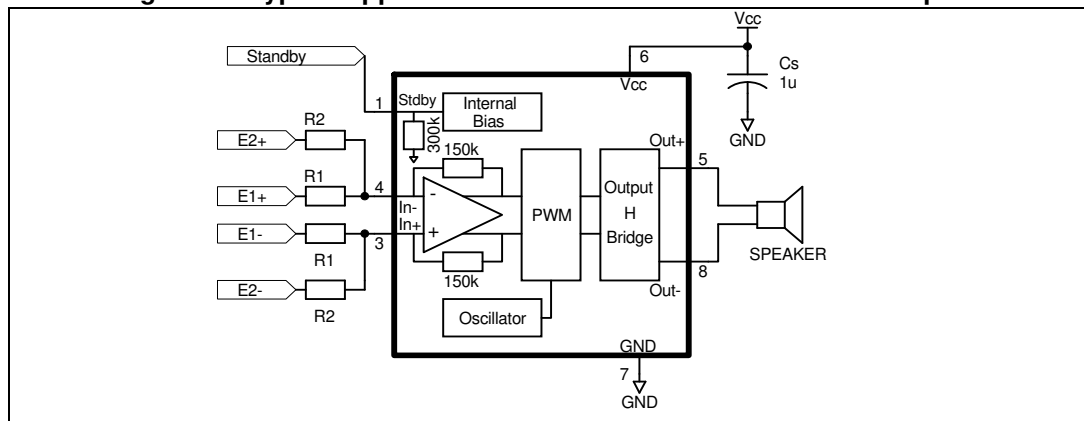

With ( $R_i$  in  $k\Omega$ ):

$$A_{V_1} = \frac{Out^+ - Out^-}{E_1^+ - E_1^-} = \frac{300}{R_1}$$

$$A_{V_2} = \frac{Out^+ - Out^-}{E_2^+ - E_2^-} = \frac{300}{R_2}$$

$$0.5V \leq \frac{V_{CC} \times R_1 \times R_2 + 300 \times (V_{IC1} \times R_2 + V_{IC2} \times R_1)}{300 \times (R_1 + R_2) + 2 \times R_1 \times R_2} \leq V_{CC} - 0.8V$$

$$V_{IC1} = \frac{E_1^+ + E_1^-}{2} \quad \text{and} \quad V_{IC2} = \frac{E_2^+ + E_2^-}{2}$$

4.11.2 Example 2: one differential input plus one single-ended input

Figure 65. Typical application schematic with one differential input and one single-ended input

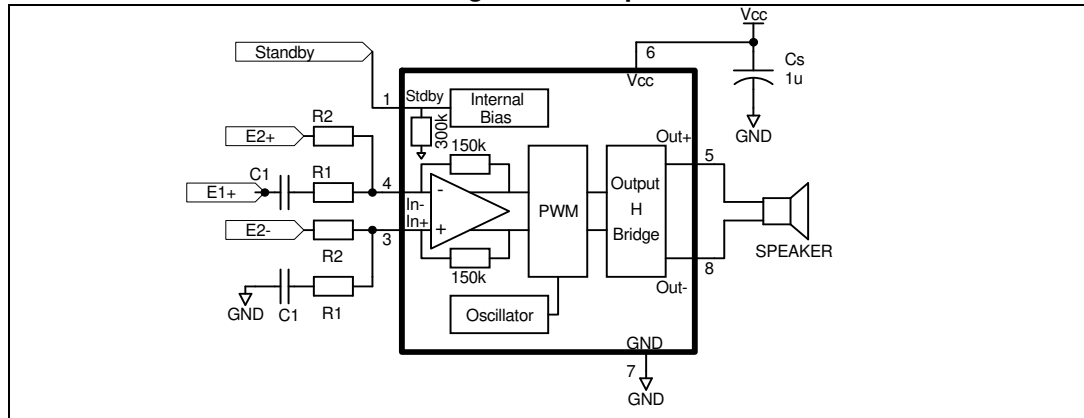

With ( $R_i$  in  $k\Omega$ ):

$$A_{V_1} = \frac{Out^+ - Out^-}{E_1^+} = \frac{300}{R_1}$$

$$A_{V_2} = \frac{Out^+ - Out^-}{E_2^+ - E_2^-} = \frac{300}{R_2}$$

$$C_1 = \frac{1}{2\pi \times R_1 \times F_{CL}} \quad (F)$$

# 5 Demonstration board

A demonstration board for the TS4962 is available. For more information about this demonstration board, refer to the application note AN2406 "TS4962IQ class D audio amplifier evaluation board user guidelines" available on [www.st.com](http://www.st.com).

**Figure 66. Schematic diagram of mono class D demonstration board for the TS4962 DFN package**

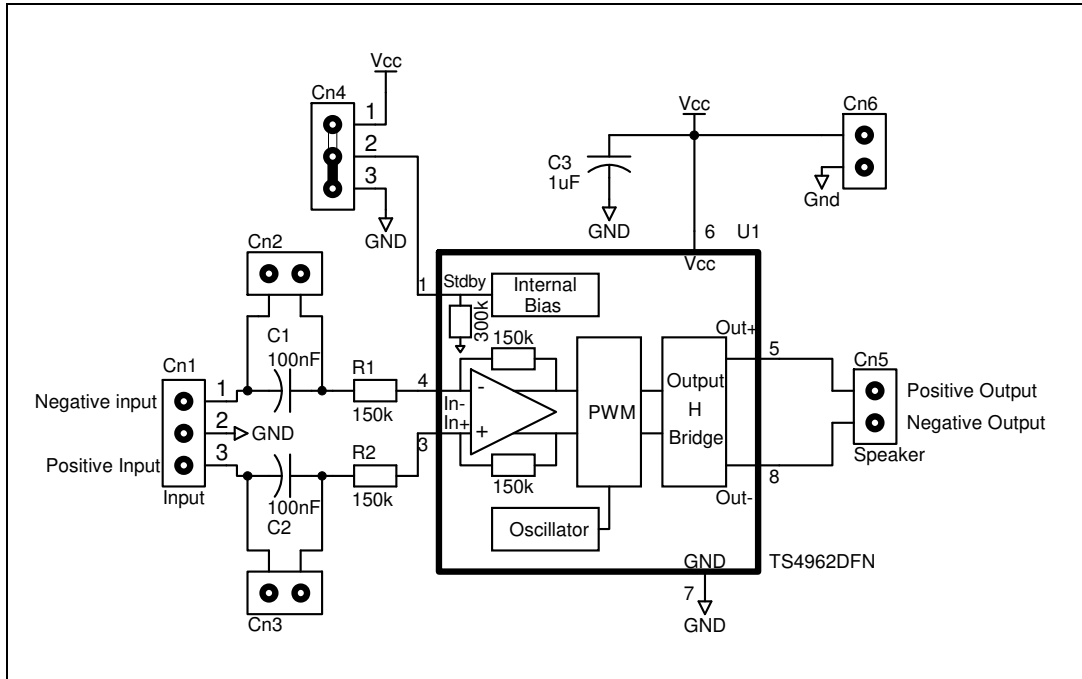

**Figure 67. Top view**

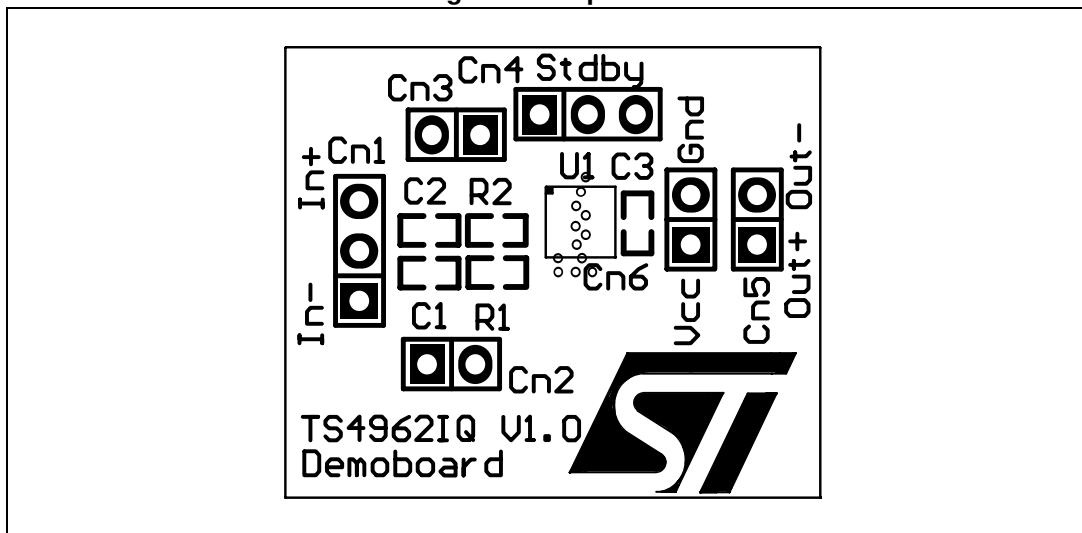

Figure 68. Bottom layer

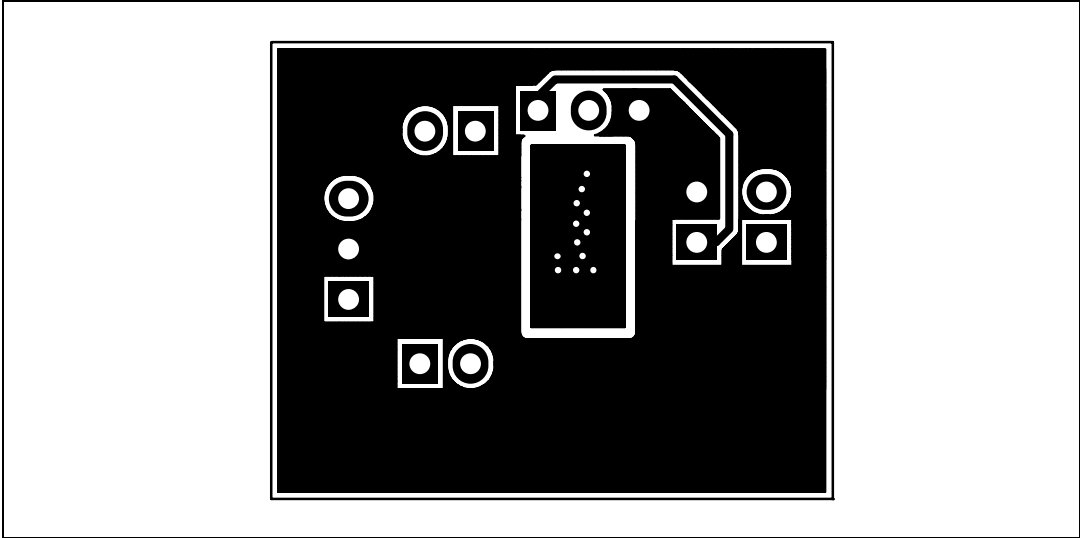
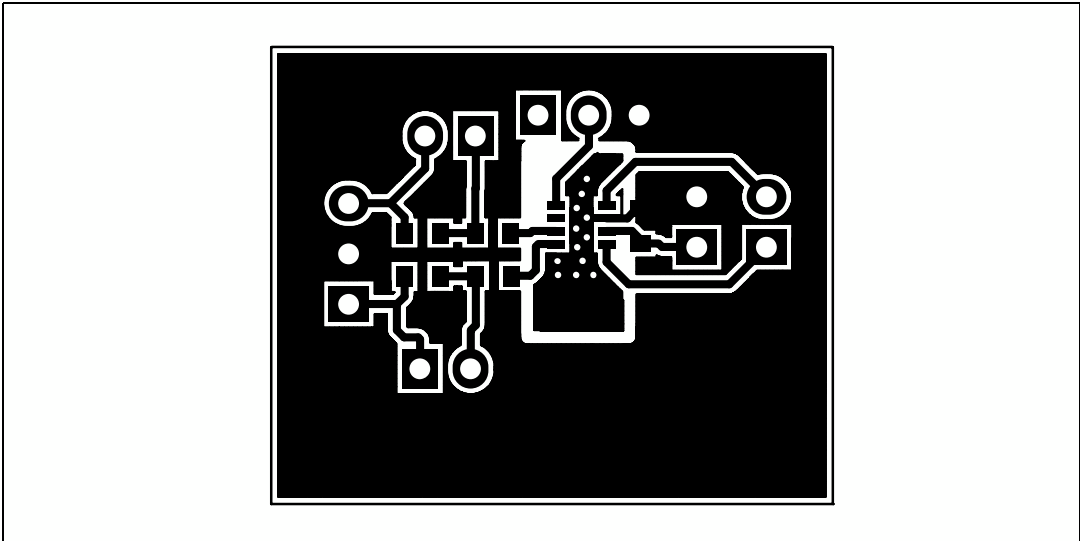
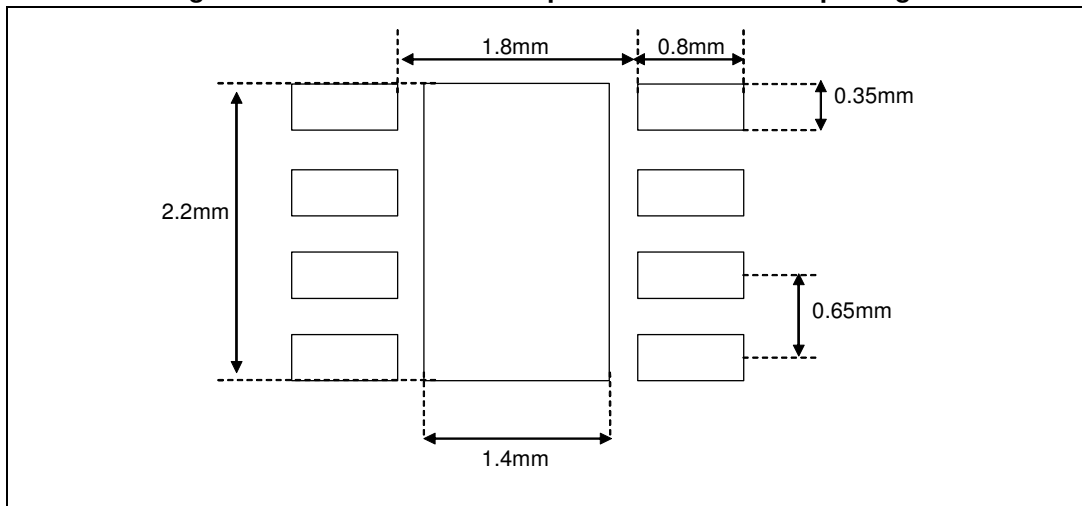

Figure 69. Top layer



## 6 Recommended footprint

Figure 70. Recommended footprint for TS4962 DFN package



## 7 Package information

In order to meet environmental requirements, ST offers these devices in different grades of ECOPACK packages, depending on their level of environmental compliance. ECOPACK specifications, grade definitions and product status are available at: [www.st.com](http://www.st.com). ECOPACK is an ST trademark.



Figure 71. DFN8 3 x 3 exposed pad package mechanical drawing (pitch 0.65 mm)

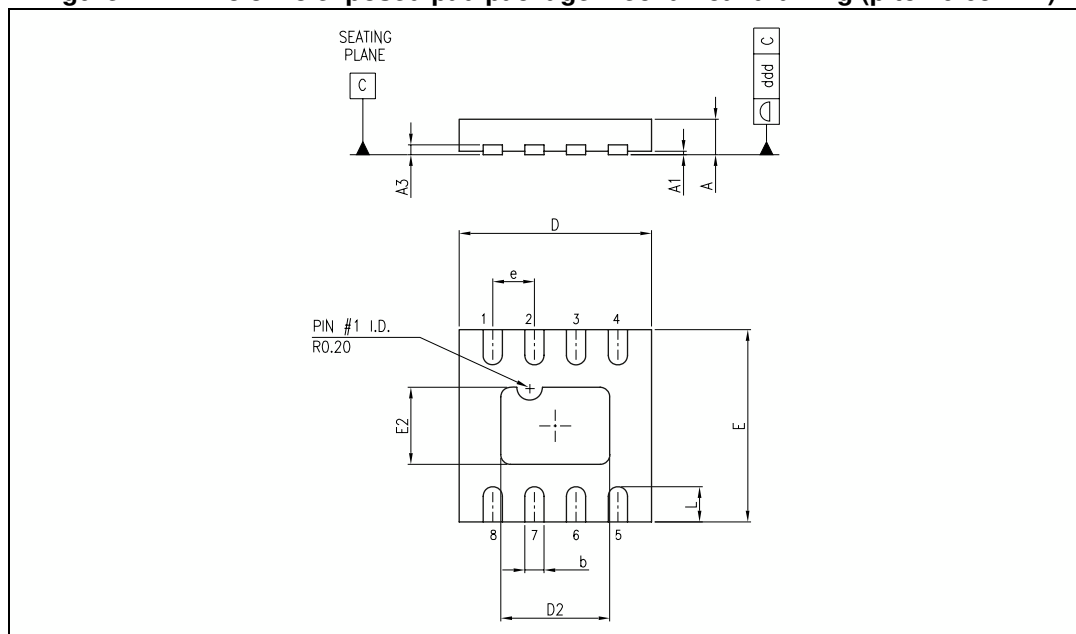

Table 12. DFN8 3 x 3 exposed pad package mechanical data (pitch 0.65 mm)

Ref.	Dimensions					
	Millimeters			Inches		
	Min.	Typ.	Max.	Min.	Typ.	Max.
A	0.50	0.60	0.65	0.020	0.024	0.026
A1		0.02	0.05		0.0008	0.002
A3			0.22			0.009
b	0.25	0.30	0.35	0.010	0.012	0.014
D	2.85	3.00	3.15	0.112	0.118	0.124
D2	1.60	1.70	1.80	0.063	0.067	0.071
E	2.85	3.00	3.15	0.112	0.118	0.124
E2	1.10	1.20	1.30	0.043	0.047	0.051
e		0.65			0.026	
L	0.50	0.55	0.60	0.020	0.022	0.024
ddd			0.08			0.003

- Note: 1 The pin 1 identifier must be visible on the top surface of the package by using an indentation mark or other feature of the package body. Exact shape and size of this feature are optional.
- 2 The dimension L does not conform with JEDEC MO-248, which recommends 0.40+/-0.10 mm.
- For enhanced thermal performance, the exposed pad must be soldered to a copper area on the PCB, acting as a heatsink. This copper area can be electrically connected to pin 7 or left floating.

## 8 Ordering information

**Table 13. Order codes**

<b>Part number</b>	<b>Temperature range</b>	<b>Package</b>	<b>Packaging</b>	<b>Marking</b>
TS4962IQT	-40°C, +85°C	DFN8	Tape & reel	K962

## 9 Revision history

**Table 14. Document revision history**

<b>Date</b>	<b>Revision</b>	<b>Changes</b>
31-May-2006	5	Modified package information. Now includes only standard DFN8 package.
16-Oct-2006	6	Added curves in Section 3: Electrical characteristics. Added evaluation board information in Section 5: Demonstration board Added recommended footprint.
10-Jan-2007	7	Added paragraph about rated voltage of capacitor in Section 4.5: Decoupling of the circuit.
18-Jan-2010	8	Added Table 5: Pin description.
17-Mar-2020	9	Removed feature on the cover page.

**IMPORTANT NOTICE – PLEASE READ CAREFULLY**

STMicroelectronics NV and its subsidiaries (“ST”) reserve the right to make changes, corrections, enhancements, modifications, and improvements to ST products and/or to this document at any time without notice. Purchasers should obtain the latest relevant information on ST products before placing orders. ST products are sold pursuant to ST’s terms and conditions of sale in place at the time of order acknowledgement.

Purchasers are solely responsible for the choice, selection, and use of ST products and ST assumes no liability for application assistance or the design of Purchasers’ products.

No license, express or implied, to any intellectual property right is granted by ST herein.

Resale of ST products with provisions different from the information set forth herein shall void any warranty granted by ST for such product.

ST and the ST logo are trademarks of ST. For additional information about ST trademarks, please refer to [www.st.com/trademarks](http://www.st.com/trademarks). All other product or service names are the property of their respective owners.

Information in this document supersedes and replaces information previously supplied in any prior versions of this document.

© 2020 STMicroelectronics – All rights reserved