

Type C1T

Surface Mount Slow Blow Chip Fuse

HF  C1T Series – 1206 Size

RoHS Compliant

Features

- Slow Blow
- Small size, 1206 SMD
- Current rating from 750mA to 8A
- Wide operating temperature range from -55°C to 125°C
- Tape and Reel for automatic SMD placement
- Compatible with 260°C IR Pb-free and wave soldering process
- Full compliance with EU Directive 2011/65/EU and amending directive 2015/863 (MSL = 1)
- Halogen Free and Lead Free
- AEC-Q Compliant
- Meets Bel automotive qualification*
- * - Largely based on internal AEC-Q test plan

Applications

- Notebook
- Automotive Navigation System
- LED Headlights
- Thin film transistor LCD flat-panel display screen
- PC computer
- Office electronic equipment
- Industrial equipment
- Medical equipment
- POE, POE+
- LCD / LED monitor and LCD / LED TV
- Power supply
- DC-DC Converter

LEAD FREE = 
 HALOGEN FREE = 



AEC-Q Compliant

Typical Part Marking

Fuse body (ceramic white side) marked with marking code.

Example:





Current Rating	Marking Code	Current Rating	Marking Code
750mA	TM	3A	T3
1A	T1	3.5A	TZ
1.25A	TP	4A	T4
1.5A	TR	5A	T5
1.75A	TS	6A	T6
2A	T2	7A	T7
2.5A	TT	8A	T8

Electrical Characteristics (UL STD. 248-14)



Testing Current	Blow Time	
	Minimum	Maximum
100%	4 Hrs.	N/A
200%	1 Sec	120 Sec
300%	0.1 Sec	3 Sec
800%	0.002 Sec	0.05 Sec

Safety Agency Approvals

Safety Agency	Safety Agency Certificate	Ampere Rating / Voltage Rating	Ampere Range / Volt @ I.R. ability*
	E20624	750mA-8A/63V AC/DC	750mA-8A/63V AC/DC @ 50A
	R 50410861 Tested according to IEC 60127-1: 2006+A1+A2 IEC 60127-7: 2016	750mA-1.5A/63V AC/DC 2A-8A/63V AC/DC	750mA-1.5A/63V AC/DC @ 50A or 10In, which is higher 2A-8A/63V AC/DC @ 50A or 10In, which is higher

*I.R.= Interrupting Rating = Short Circuit Rating(Amps)

Physical Specifications

Materials	Body : Ceramic Substrate
	Terminations : Ag / Ni / Sn (100% Lead-free)
	Element Cover Coating : Lead-free Glass
Marking	On Fuse :
	Marking Code
	On Label :
	"bel", "C1T", "Current Rating", "Voltage Rating", "Interrupting Rating", "Appropriate Safety Logos" and "  ", "  " (China RoHS compliant).

Specifications subject to change without notice

Temperature Derating Curve

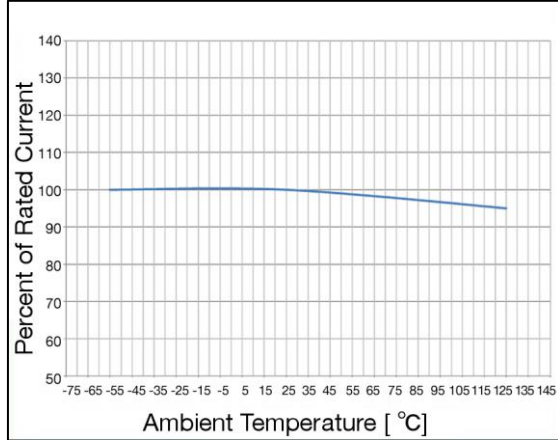

Average Time Current Curve

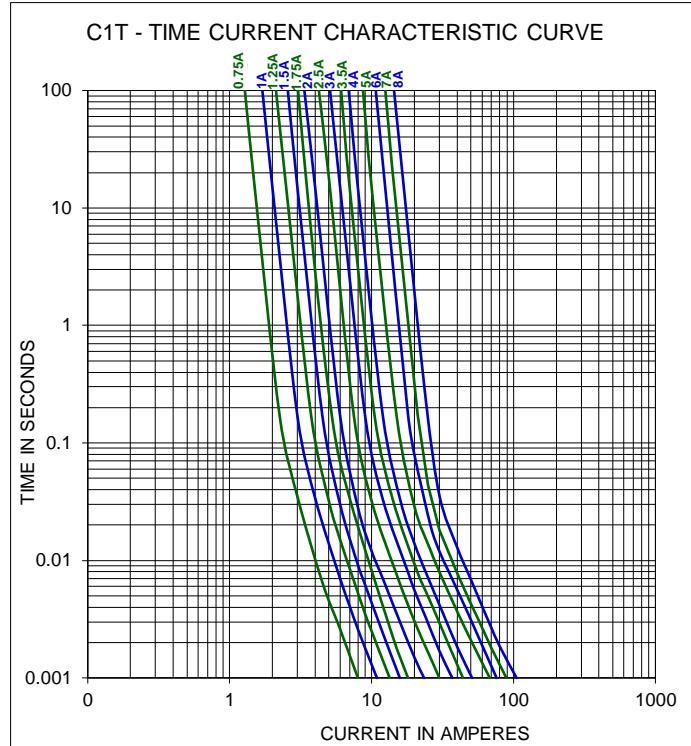

Electrical Specifications

Part Number	Ampere Rating (A)	Marking Code	Nominal Cold Resistance (ohms)	Maximum Volt-drop @ 100% In (Volt) max.	Voltage and Interrupting Ratings	Nominal Melting I²T @ 10 In (A² Sec)	Maximum Power Dissipation @ 100% In (W)	Agency Approvals	
0685T0750-XX	750mA	TM	0.700	0.795	See Table of Safety Approvals on Page 1 for Voltage and associated Interrupting Ratings	0.06	0.60	Y	Y
0685T1000-XX	1A	T1	0.460	0.597		0.12	0.60	Y	Y
0685T1250-XX	1.25A	TP	0.300	0.541		0.20	0.68	Y	Y
0685T1500-XX	1.5A	TR	0.190	0.436		0.23	0.65	Y	Y
0685T1750-XX	1.75A	TS	0.135	0.395		0.43	0.65	Y	
0685T2000-XX	2A	T2	0.110	0.325		0.63	0.65	Y	Y
0685T2500-XX	2.5A	TT	0.068	0.274		1.07	0.69	Y	Y
0685T3000-XX	3A	T3	0.050	0.232		1.64	0.70	Y	Y
0685T3500-XX	3.5A	TZ	0.040	0.194		2.28	0.68	Y	Y
0685T4000-XX	4A	T4	0.030	0.195		2.56	0.78	Y	Y
0685T5000-XX	5A	T5	0.020	0.157		5.3	0.79	Y	Y
0685T6000-XX	6A	T6	0.0145	0.153		6.0	0.92	Y	Y
0685T7000-XX	7A	T7	0.0115	0.139		6.9	0.97	Y	Y
0685T8000-XX	8A	T8	0.0095	0.135		8.0	1.08	Y	Y

Consult manufacturer for other ratings

NOTES: Test Conditions

All test for ratings 750mA - 5A were conducted with fuse samples soldered on a PCB (1.6mm thick) test board with copper traces measuring 0.035 mm (35µm) nominal thickness (1 oz. clad), 5mm wide and 100 mm overall length.

All test for ratings 6A-8A were conducted with fuse samples soldered on a PCB (1.6mm thick) test board with copper traces measuring 0.070 mm (70µm) nominal thickness (2 oz. clad), 7.5mm wide and 100 mm overall length.

Device designed to be mounted with marking facing up.

Device designed to carry rated current for 4 hours minimum. It is recommended that device be operated continuously at no more than 80% of rated current when in a +25°C ambient, with further derating at elevated ambient temperatures.



Specifications subject to change without notice

Bel Fuse Inc.
206 Van Vorst Street
Jersey City, NJ 07302 USA

+1 201.432.0463
Bel.US.CS@belf.com
belfuse.com/circuit-protection

Environmental Specifications

Shock Resistance	MIL-STD-202G, Method 213B, Test Condition 1 (100 G's peak for 6 milliseconds; Sawtooth waveform)
Vibration Resistance	MIL-STD-202G, Method 201A (10-55 Hz, 0.06 inch, total excursion).
Salt Spray Resistance	MIL-STD-202G, Method 101E, Test Condition B (48 hrs.).
Insulation Resistance	MIL-STD-202G, Method 302, Test Condition A (After Opening) 10,000 ohms minimum.
Solderability	MIL-STD-202G, Method 208H
Resistance to solder Heat	MIL-STD-202G, Method 210F, Test Condition C. Top Side(260°C,20 sec) MIL-STD-202G, Method 210F, Test Condition D. Bottom Side(260°C, 10 sec)
Thermal Shock	MIL-STD-202G, Method 107G, Test Condition B (-65°C to +125°C).
Operating Temperature	-55°C to +125°C
Moisture Sensitivity Level	1 (According to IPC J-Std-020)

High temperature storage	MIL-STD-202 Method 108
Temperature cycling	JESD22 Method JA-104, Test Condition B
Biased humidity	MIL-STD-202 Method 103, 85C/85% RH with 10% operating power for 1000 hrs.
Operational life	MIL-STD-202 Method 108, Test Condition D
Resistance to solvents	MIL-STD-202 Method 215
Mechanical shock	MIL-STD-202 Method 213, Test Condition C
Vibration	MIL-STD-202 Method 204
Resistance to soldering heat	MIL-STD-202 Method 210, Test condition B
Thermal shock	MIL-STD-202 Method 107
Solderability	J-STD-002
Board flex(SMD)	AEC-Q200-005
Terminal strength	AEC-Q200-006
Electrical characterization	3 temperature electrical

Soldering Parameters

IR Reflow Profile (IPC/JEDEC J-STD-020D)	
Preheat & Soak	
Temperature min (T_{smin})	150°C
Temperature max (T_{smax})	200°C
Time (T_{smin} to T_{smax}) (t_s)	60-120 seconds
Average ramp-up rate (T_{smax} to T_p)	3°C/second max.
Liquidous temperature (T_L)	217°C
Time at liquidous (t_L)	60-150 seconds
Peak temperature (T_p)	260°C max
Time (t_p) within 5°C of the specified classification temperature (T_c)	30 seconds
Average ramp-down rate (T_p to T_{smax})	6°C/second max.
Time 25°C to peak temperature	8 minutes max.

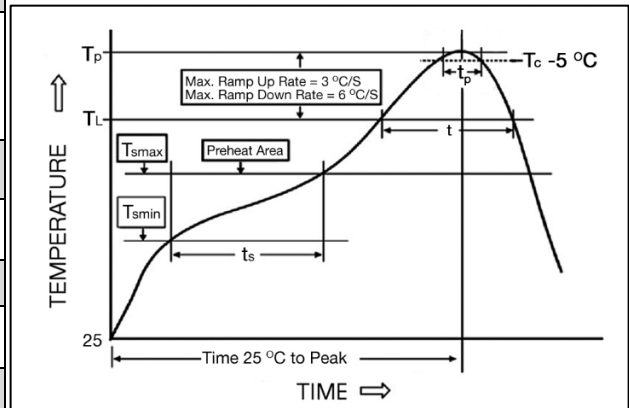

Lead-free Wave Soldering Profile	
Wave Soldering Parameter	
Average ramp-up rate	200°C / second
Heating rate during preheat	typical 1 - 2°C / second Max 4°C / second
Final preheat temperature	within 125°C of soldering temperature
Peak temperature T_p	260°C
Time within +0°C / -5°C of actual peak temperature	10 seconds
Ramp-down rate	5°C / second max.

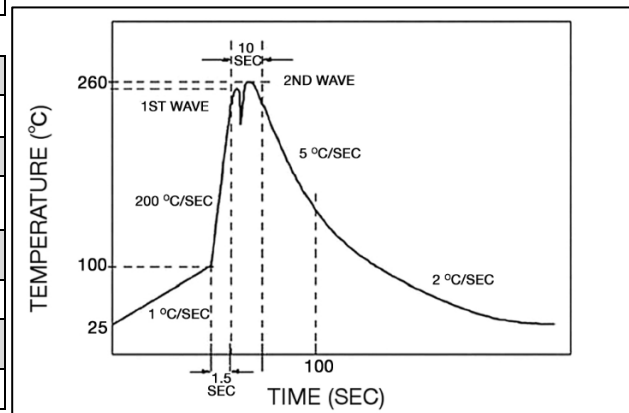

Specifications subject to change without notice

Bel Fuse Inc.
206 Van Vorst Street
Jersey City, NJ 07302 USA

+1 201.432.0463
Bel.US.CS@belf.com
belfuse.com/circuit-protection

Type C1T

Fuse FGNO Explanation

0685 T [XXXX] -XX

0685T=C1T; [XXXX]=Ampere Rating; XX=See Ordering Information as below

Fraction	Decimal	Milliamps	Bel FGNO[XXXX]
3/4	0.750	750	0750

Fraction	Decimal	Amps	Bel FGNO[XXXX]
	1.0	1	1000
1-1/4	1.25	1.25	1250
1-1/2	1.50	1.5	1500
	1.75	1.75	1750
	2.0	2	2000
2-1/2	2.5	2.5	2500
	3.0	3	3000
3-1/2	3.5	3.5	3500
	4.0	4	4000
	5.0	5	5000
	6.0	6	6000
	7.0	7	7000
	8.0	8	8000

Mechanical Dimensions

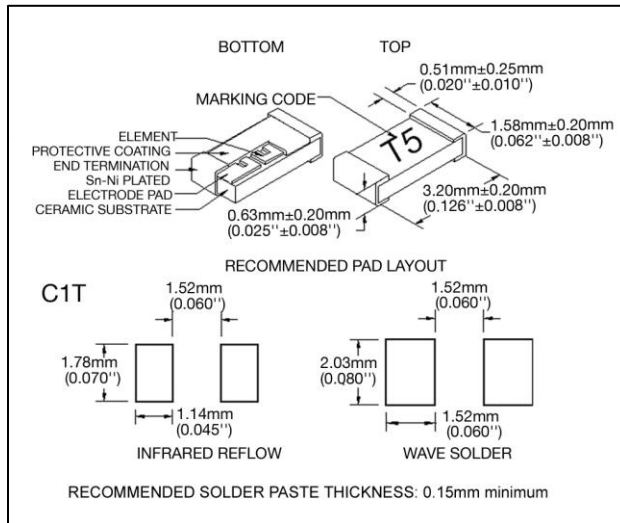

Ordering Information

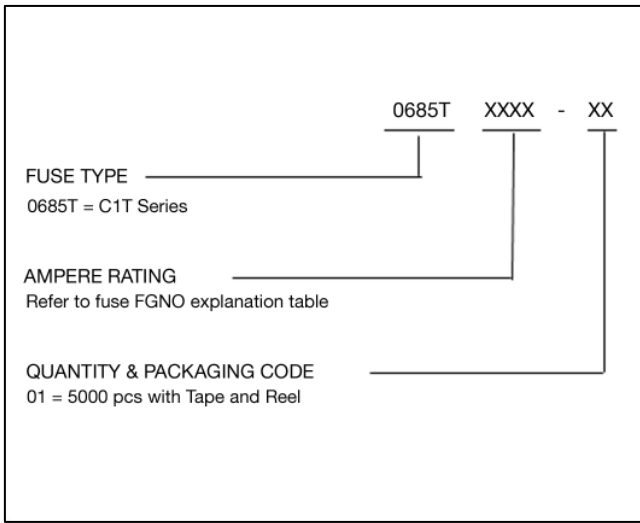

Packaging

Packaging Tape & Reel	Packaging Specification	Quantity	Quantity & Packaging Code
8 mm wide tape with 7 inches Diameter reel	EIA Standard 481-E	5000	0685TXXXX-01



Specifications subject to change without notice

Bel Fuse Inc.
206 Van Vorst Street
Jersey City, NJ 07302 USA

+1 201.432.0463
Bel.US.CS@belf.com
belfuse.com/circuit-protection