

Circuit Breaker for Equipment thermal vertical, THT terminals for PCB mounting, 1 pole



See below:  
[Approvals and Compliances](#)

**Description**

- Thermal circuit breaker
- 1-pole
- On request available with elevated glow-wire ratings
- THT connectors

**Unique Selling Proposition**

- Reset type
- Cycling trip-free release
- Compact design
- Different mounting possibilities

**Applications**

- Power supplies
- Uninterruptible power supply
- Power tools
- Industrial appliances
- HVAC
- Household appliances

**Weblinks**

[pdf data sheet](#), [html datasheet](#), [General Product Information](#), [Distributor-Stock-Check](#), [Detailed request for product](#), [Product News](#), [Video](#)

**Technical Data**

Rated Voltage AC	240
Rated Voltage DC	48
Rated current	4-12 A
Conditional short circuit capacity Inc	IEC 60934: PC1, AC 240 V: 2 kA UL / CSA: SC, AC 240 V DC 48 / 32 V: 2 kA, C1
Degree of protection front side	IP40
Endurance minimum	IEC: 200% I <sub>r</sub> , cos φ 0.6: min. 50 switching cycles
Endurance typical	4-8 A: 150% I <sub>r</sub> , cos φ 0.9: 2500 switching cycles 10-12 A: 150% I <sub>r</sub> , cos φ 0.9: 6000 switching cycles
Dielectric Strength	1500 VAC
Insulation Resistance	500 VDC > 1000 MΩ

Allowable Operation Temp.	5-12 A: -5 °C to 60 °C 4 A: -5°C to 50 °C
Soldering Methods	Wave
Solderability	245 °C / 3 sec acc. to IEC 60068-2-20 / Test Ta, method 1
Resistance to Soldering Heat	260 °C / 10 sec acc. to IEC 60068-2-20 / Test Tb, method 1A
Weight	approx. 12.5 g

**Approvals and Compliances**

Detailed information on product approvals, code requirements, usage instructions and detailed test conditions can be looked up in [Details about Approvals](#)

SCHURTER products are designed for use in industrial environments. They have approvals from independent testing bodies according to national and international standards. Products with specific characteristics and requirements such as required in the automotive sector according to IATF 16949, medical technology according to ISO 13485 or in the aerospace industry can be offered exclusively with customer-specific, individual agreements by SCHURTER.





**Approvals**

The approval mark is used by the testing authorities to certify compliance with the safety requirements placed on electronic products.  
 Approval Reference Type: T9

Approval Logo	Certificates	Certification Body	Description
	<a href="#">VDE Approvals</a>	VDE	VDE Certificate Number: 40038016
	<a href="#">UL Approvals</a>	UL	UR File Number: E71572
	<a href="#">CCC Approvals</a>	CCC	CCC Certificate Number: 2020970307003348

## Product standards

Product standards that are referenced

Organization	Design	Standard	Description
	Designed according to	IEC 60934	Circuit-breakers for equipment (CBE)
	Designed according to	UL 1077	Standard for Supplementary Protectors for Use in Electrical Equipment
	Designed according to	CSA C22.2 No. 235	Supplementary Protectors
	Designed according to	GB 17701	Circuit-breaker for equipment





## Application standards

Application standards where the product can be used

Organization	Design	Standard	Description
	Suitable for applications acc.	IEC/UL 62368-1	Audio/video, information and communication technology equipment - Part 1: Safety requirements





## Compliances

The product complies with following Guide Lines

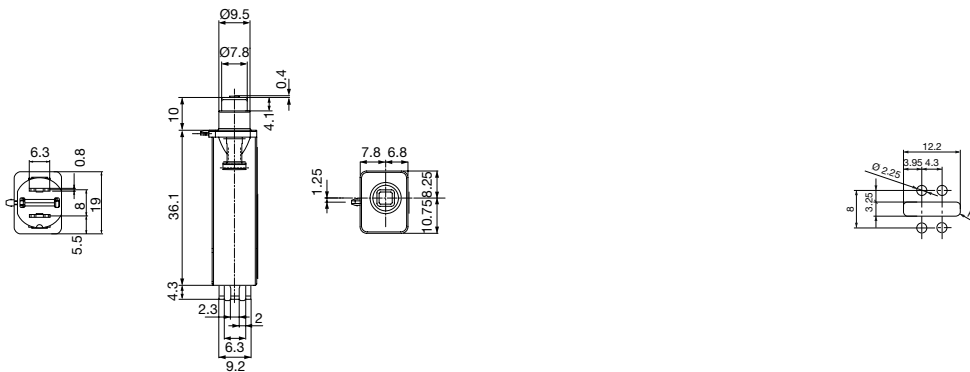
Identification	Details	Initiator	Description
	<a href="#">CE declaration of conformity</a>	SCHURTER AG	The CE marking declares that the product complies with the applicable requirements laid down in the harmonisation of Community legislation on its affixing in accordance with EU Regulation 765/2008.
	<a href="#">UKCA declaration of conformity</a>	SCHURTER AG	The UKCA marking declares that the product complies with the applicable requirements laid down in the British Amendment of Regulation (EC) 765/2008.
	RoHS	SCHURTER AG	Directive RoHS 2011/65/EU, Amendment (EU) 2015/863
	China RoHS	SCHURTER AG	The law SJ / T 11363-2006 (China RoHS) has been in force since 1 March 2007. It is similar to the EU directive RoHS.
	REACH	SCHURTER AG	On 1 June 2007, Regulation (EC) No 1907/2006 on the Registration, Evaluation, Authorization and Restriction of Chemicals 1 (abbreviated as "REACH") entered into force.

## Dimension [mm]



Approval		Rated current	Rated Voltage AC	Rated Voltage DC
	UL 1077	4 - 12 A	240 V	48 V
	CSA 22.2 235	4 - 12 A	240 V	48 V
	IEC 60934	4 - 12 A	240 V	48 V
	GB 17701	4 - 12 A	240 V	48 V

**Time-Current-Curves**

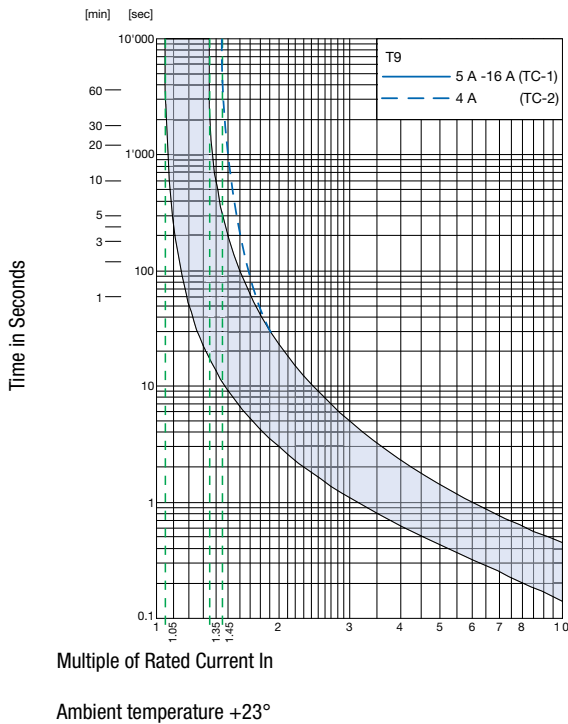

**Effect of ambient temperature**

The units are calibrated for an ambient temperature of +23°C. To determine the rated current for a lower or higher ambient temperature, use a correction factor (typical value) from the table below:

Ambient Temperature [°C]	Correction factor
-5	0,85
+10	0,95
+23	1,00
+40	1,08
+60	1,21

Example: Rated current = 10 A, Environmental temperature = 60 °C, --> Correction factor = 1.21, Resulting current = 12.1 A --> Round to next higher rated current: 13 A

**All Variants**

Config. Code	Designation	Order Number
T9--0	T9, Circuit Breakers, , , , ,	3-101-226
T9--0	T9, Circuit Breakers, , , , ,	3-101-227
T9--0	T9, Circuit Breakers, , , , ,	3-101-228
T9--0	T9, Circuit Breakers, , , , ,	3-101-229
T9--0	T9, Circuit Breakers, , , , ,	3-101-230
T9--0	T9, Circuit Breakers, , , , ,	3-101-231
T9--0	T9, Circuit Breakers, , , , ,	3-101-232

The listed variants should be available from stock. Other versions on request [www.schurter.com/contact](http://www.schurter.com/contact)

Availability for all products can be searched real-time: <https://www.schurter.com/en/Stock-Check/Stock-Check-SCHURTER>

**Packaging Unit** 100 Pcs