

ISL80101-ADJ

High Performance 1A LDO

FN7834
Rev 3.00
August 26, 2015

The [ISL80101-ADJ](#) is a low voltage, high current, single output LDO specified at 1A output current. This LDO operates from input voltages from 2.2V to 6V, and is capable of providing output voltages from 0.8V to 5V. The ISL80101-ADJ features an adjustable output. For the fixed output version of the ISL80101-ADJ, please refer to the [ISL80101](#) datasheet.

A submicron BiCMOS process is utilized for this product family to deliver the best in class analog performance and overall value. This CMOS LDO will consume significantly lower quiescent current as a function of load compared to bipolar LDOs, which translates into higher efficiency and packages with smaller footprints. State of the art internal compensation achieves a very fast load transient response. An external capacitor on the soft-start pin provides an adjustable soft-starting ramp. The ENABLE feature allows the part to be placed into a low quiescent current shutdown mode. A Power-good logic output signals a fault condition.

[Table 1](#) shows the differences between the ISL80101-ADJ and others in its family:

TABLE 1. KEY DIFFERENCES BETWEEN FAMILY OF PARTS

PART NUMBER	PROGRAMMABLE I _{LIMIT}	I _{LIMIT} (DEFAULT)	ADJ OR FIXED V _{OUT}
ISL80101-ADJ	No	1.75A	ADJ
ISL80101	No	1.75A	1.8V, 2.5V, 3.3V, 5.0V
ISL80101A	Yes	1.62A	ADJ
ISL80121-5	Yes	0.75A	5.0V

Features

- ±1.8% V_{OUT} accuracy guaranteed over line, load and T_J = -40 °C to +125 °C
- Very low 130mV dropout voltage at V_{OUT} = 2.5V
- Very fast transient response
- Programmable soft-starting
- Power-good output
- Excellent 65dB PSRR
- Current limit protection
- Thermal shutdown function
- Available in a 10 Ld DFN package
- Pb-Free (RoHS compliant)

Applications

- DSP, FPGA and μP core power supplies
- Noise-sensitive instrumentation systems
- Post regulation of switched mode power supplies
- Industrial systems
- Medical equipment
- Telecommunications and networking equipment
- Servers
- Hard disk drives (HD/HDD)

Related Literature

- [AN1592](#), "ISL80101 High Performance 1A LDO Evaluation Board User Guide"

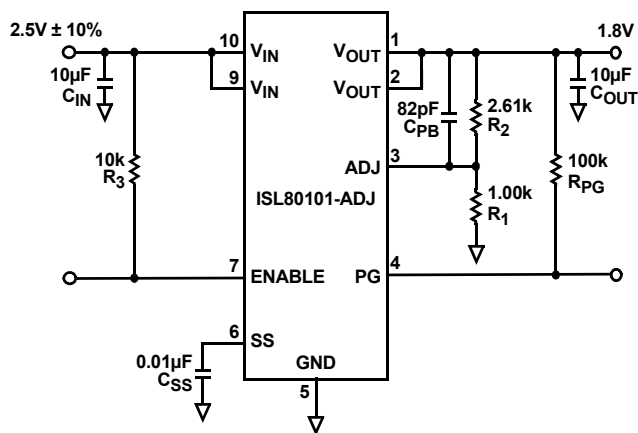

FIGURE 1. TYPICAL APPLICATION CIRCUIT

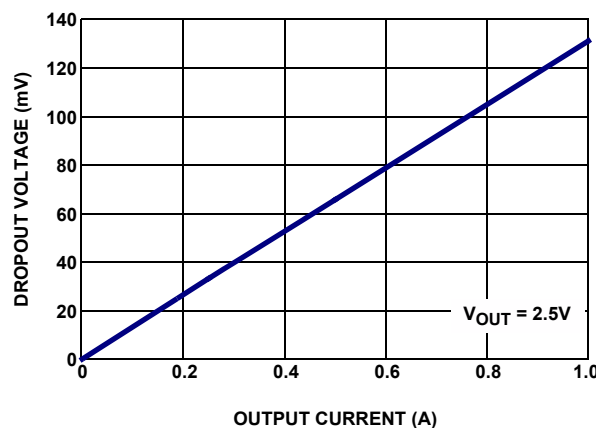
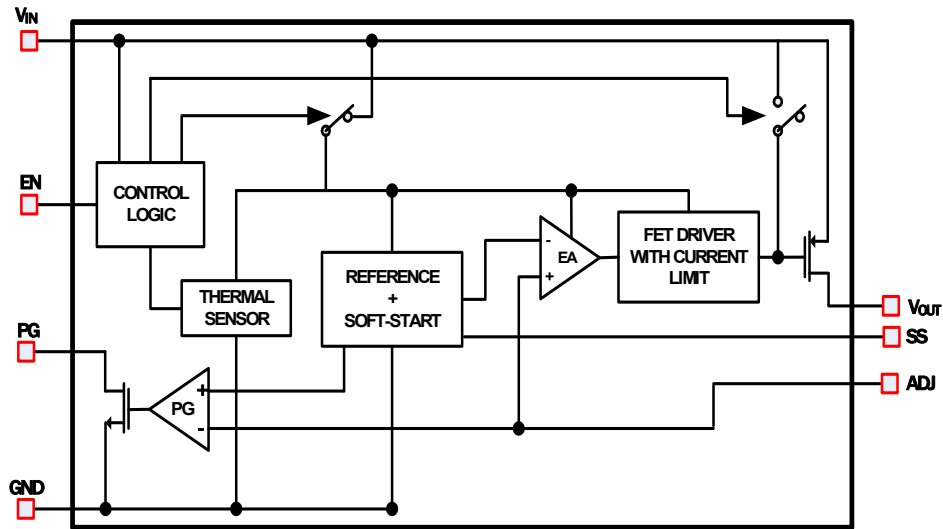

FIGURE 2. DROPOUT vs LOAD CURRENT

Block Diagram



Ordering Information

PART NUMBER (Notes 3, 4)	PART MARKING	V _{OUT} VOLTAGE (Note 2)	TEMP RANGE (°C)	PACKAGE (RoHS Compliant)	PKG DWG. #
ISL80101IRAJZ (Note 1)	DZAB	ADJ	-40 to +125	10 Ld 3x3 DFN	L10.3x3
ISL80101EVAL2Z	Evaluation Board				

NOTES:

1. Add "-T*" for Tape and Reel. Please refer to [TB347](#) for details on reel specifications.
2. For other output voltages, contact Intersil Marketing.
3. These Intersil Pb-free plastic packaged products employ special Pb-free material sets, molding compounds/die attach materials, and 100% matte tin plate plus anneal (e3 termination finish, which is RoHS compliant and compatible with both SnPb and Pb-free soldering operations). Intersil Pb-free products are MSL classified at Pb-free peak reflow temperatures that meet or exceed the Pb-free requirements of IPC/JEDEC J STD-020.
4. For Moisture Sensitivity Level (MSL), please see product information page for [ISL80101-ADJ](#). For more information on MSL please see techbrief [TB363](#).

Pin Configurations

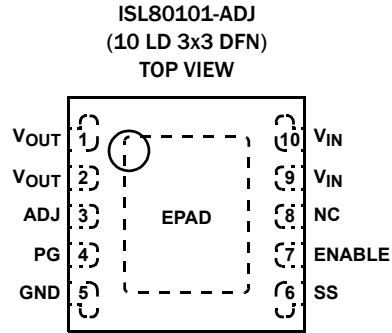

Pin Descriptions

PIN NUMBER	PIN NAME	DESCRIPTION
1, 2	V _{OUT}	Regulated output voltage. A X5R/X7R output capacitor is required for stability. See "External Capacitor Requirements" on page 8 for more details.
3	ADJ	This pin is connected to the feedback resistor divider and provides voltage feedback signals for the LDO to set the output voltage. In addition, the PGOOD circuit uses this input to monitor the output voltage status.
4	PG	This is an open-drain logic output used to indicate the status of the output voltage. Logic low indicates V _{OUT} is not in regulation. Must be grounded if not used.
5	GND	Ground
6	SS	External capacitor on this pin adjusts start-up ramp and controls inrush current.
7	ENABLE	V _{IN} independent chip enable. TTL and CMOS compatible.
8	NC	No connection; Leave floating.
9, 10	V _{IN}	Input supply; A minimum of 10μF X5R/X7R input capacitor is required for proper operation. See "External Capacitor Requirements" on page 8 for more details.
-	EPAD	EPAD at ground potential. It is recommended to solder the EPAD to the ground plane.

Absolute Maximum Ratings

V_{IN} Relative to GND (Note 5)	-0.3V to +6.5V
V_{OUT} Relative to GND (Note 5)	-0.3V to +6.5V
PG, ENABLE, ADJ, SS	
Relative to GND (Note 5)	-0.3V to +6.5V
ESD Rating	
Human Body Model (Tested per JESD22 A114F)	2.5kV
Charge Device Model (Tested per JESD22-C101C)	2kV
Latch-up (Tested per JESD78C, Class 2, Level A)	± 100 mA at +125°C

Thermal Information

Thermal Resistance (Typical)	θ_{JA} (°C/W)	θ_{JC} (°C/W)
10 Ld DFN Package (Notes 6, 7)	48	7
Storage Temperature Range	-65°C to +150°C	
Junction Temperature	+150°C	
Pb-Free Reflow Profile	see TB493	

Recommended Operating Conditions (Notes 8, 9)

Junction Temperature Range (T _J) (Note 8)	-40°C to +125°C
V_{IN} Relative to GND	2.2V to 6V
V_{OUT} Range	800mV to 5V
PG, ENABLE, ADJ, SS relative to GND	0V to 6V
PG Sink Current	<10mA

CAUTION: Do not operate at or near the maximum ratings listed for extended periods of time. Exposure to such conditions may adversely impact product reliability and result in failures not covered by warranty.

NOTES:

- ABS max voltage rating is defined as the voltage applied for a lifetime average duty cycle above 6V of 1%.
- θ_{JA} is measured in free air with the component mounted on a high effective thermal conductivity test board with “direct attach” features. See Tech Brief [TB379](#).
- For θ_{JC} , the “case temp” location is the center of the exposed metal pad on the package underside.
- Extended operation at these conditions may compromise reliability. Exceeding these limits will result in damage. Recommended operating conditions define limits where specifications are guaranteed.
- Electromigration specification defined as lifetime average junction temperature of +110°C where max rated DC current = lifetime average current.

Electrical Specifications Unless otherwise noted, 2.2V < V_{IN} < 6V, V_{OUT} = 0.5V, T_J = +25°C. Applications must follow thermal guidelines of the package to determine worst case junction temperature. Please refer to [“Applications Information” on page 8](#) and Tech Brief [TB379](#). **Boldface limits apply across the operating temperature range, -40°C to +125°C.**

PARAMETER	SYMBOL	TEST CONDITIONS	MIN (Note 10)	TYP	MAX (Note 10)	UNITS
DC CHARACTERISTICS						
Feedback Pin (ADJ Option Only)	V_{ADJ}	$V_{OUT} + 0.4V < V_{IN} < 6V$, $V_{OUT} = 2.5V$, $0A < I_{LOAD} < 1A$	491	500	509	mV
DC Input Line Regulation	$(V_{OUT \text{ low line}} - V_{OUT \text{ high line}}) / V_{OUT \text{ low line}}$	$V_{OUT} + 0.4V < V_{IN} < 6V$, $V_{OUT} = 2.5V$	-1		1	%
DC Output Load Regulation	$(V_{OUT \text{ no load}} - V_{OUT \text{ high load}}) / V_{OUT \text{ no load}}$	$0A < I_{LOAD} < 1A$, $V_{OUT} = 2.5V$	-1		1	%
Feedback Input Current		$V_{ADJ} = 0.5V$		0.01	1	μA
Ground Pin Current	I_Q	$I_{LOAD} = 0A$, $V_{OUT} + 0.4V < V_{IN} < 6V$, $V_{OUT} = 2.5V$		3	5	mA
		$I_{LOAD} = 1A$, $V_{OUT} + 0.4V < V_{IN} < 6V$, $V_{OUT} = 2.5V$		5	7	mA
Ground Pin Current in Shutdown	I_{SHDN}	ENABLE Pin = 0.2V, $V_{IN} = 6V$		0.2	12	μA
Dropout Voltage (Note 11)	V_{DO}	$I_{LOAD} = 1A$, $V_{OUT} = 2.5V$		130	212	mV
Output Short Circuit Current	OCP	$V_{OUT} = 0V$		1.75		A
Thermal Shutdown Temperature	TSD			160		°C
Thermal Shutdown Hysteresis	TSDn			30		°C
AC CHARACTERISTICS						
Input Supply Ripple Rejection	PSRR	$f = 1\text{kHz}$, $I_{LOAD} = 1A$; $V_{IN} = 2.2V$, $V_{OUT} = 1.8V$		58		dB
		$f = 120\text{Hz}$, $I_{LOAD} = 1A$; $V_{IN} = 2.2V$, $V_{OUT} = 1.8V$		65		dB
Output Noise Voltage		$I_{LOAD} = 1A$, $BW = 100\text{Hz} < f < 100\text{kHz}$, $V_{IN} = 2.2V$, $V_{OUT} = 1.8V$		53		μV _{RMS}

Electrical Specifications Unless otherwise noted, $2.2V < V_{IN} < 6V$, $V_{OUT} = 0.5V$, $T_J = +25^\circ C$. Applications must follow thermal guidelines of the package to determine worst case junction temperature. Please refer to [“Applications Information” on page 8](#) and Tech Brief [TB379](#).

Boldface limits apply across the operating temperature range, $-40^\circ C$ to $+125^\circ C$. (Continued)

PARAMETER	SYMBOL	TEST CONDITIONS	MIN (Note 10)	TYP	MAX (Note 10)	UNITS
ENABLE PIN CHARACTERISTICS						
Turn-on Threshold			0.5	0.8	1	V
Hysteresis			10	80	200	mV
ENABLE Pin Turn-on Delay		$C_{OUT} = 10\mu F$, $I_{LOAD} = 1A$		100		μs
ENABLE Pin Leakage Current		$V_{IN} = 6V$, $ENABLE = 2.8V$			1	μA
SOFT-START CHARACTERISTICS						
SS Pin Currents (Note 12)	IPD	$V_{IN} = 3.5V$, $ENABLE = 0V$, $SS = 1V$	0.5	1	1.3	mA
	ICHG		-3.3	-2	-0.8	μA
PG PIN CHARACTERISTICS						
V_{OUT} PG Flag Threshold			75	85	92	$\%V_{OUT}$
V_{OUT} PG Flag Hysteresis				4		%
PG Flag Low Voltage		$V_{IN} = 3V$, $I_{SINK} = 500\mu A$			100	mV
PG Flag Leakage Current		$V_{IN} = 6V$, $PG = 6V$			1	μA

NOTES:

10. Compliance to datasheet limits is assured by one or more methods: production test, characterization and/or design.
11. Dropout is defined as the difference in supply V_{IN} and V_{OUT} when the supply produces a 2% drop in V_{OUT} from its nominal voltage.
12. I_{PD} is the internal pull down current that discharges the external SS capacitor on disable. I_{CHG} is the current from the SS pin that charges the external SS capacitor during start-up.

Typical Operating Performance

Unless otherwise noted: $V_{IN} = 2.2V$, $V_{OUT} = 1.8V$, $C_{IN} = C_{OUT} = 10\mu F$, $T_J = +25^\circ C$, $I_L = 0A$.

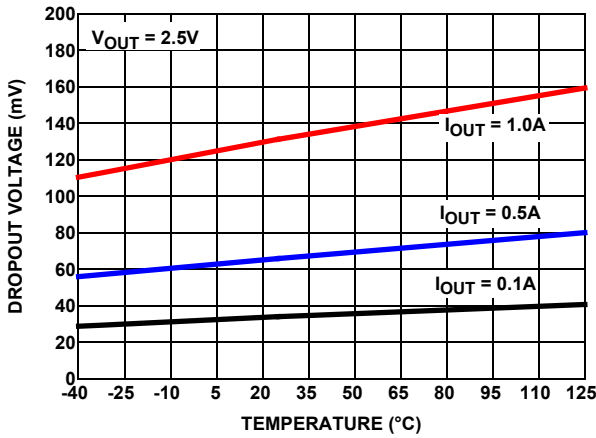

FIGURE 3. DROPOUT VOLTAGE vs TEMPERATURE

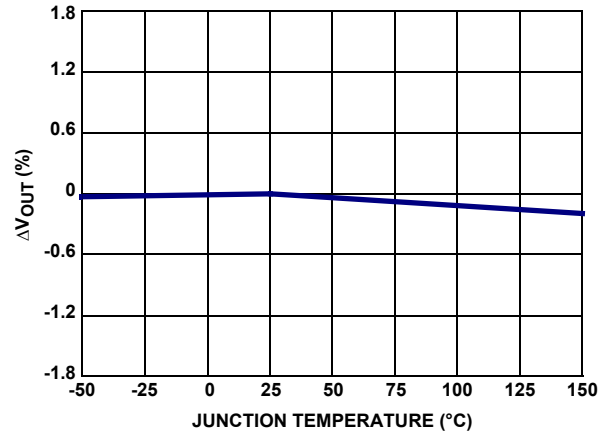

FIGURE 4. V_{OUT} vs TEMPERATURE

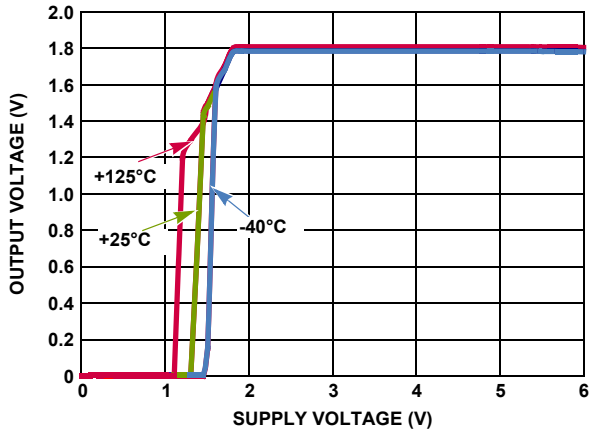

FIGURE 5. OUTPUT VOLTAGE vs SUPPLY VOLTAGE

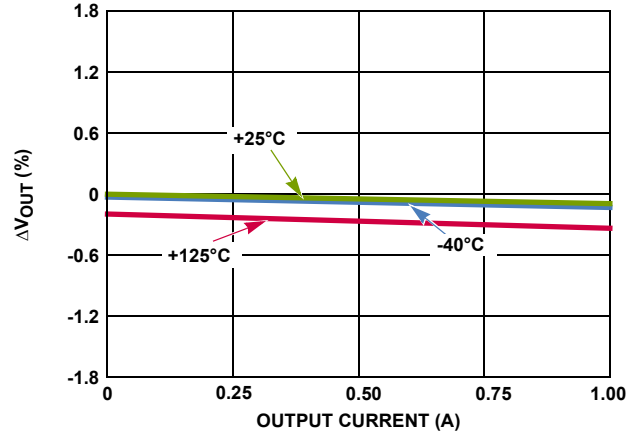

FIGURE 6. OUTPUT VOLTAGE vs OUTPUT CURRENT

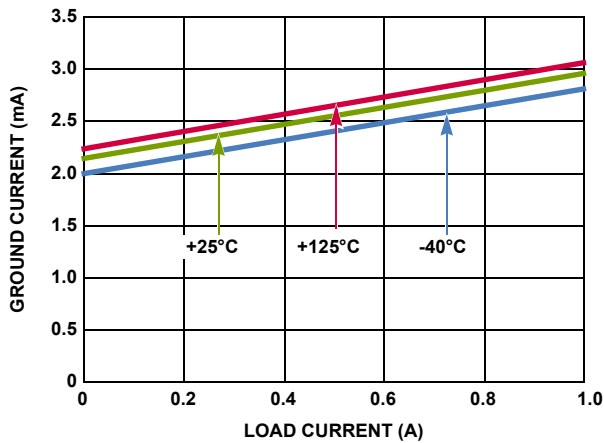

FIGURE 7. GROUND CURRENT vs LOAD CURRENT

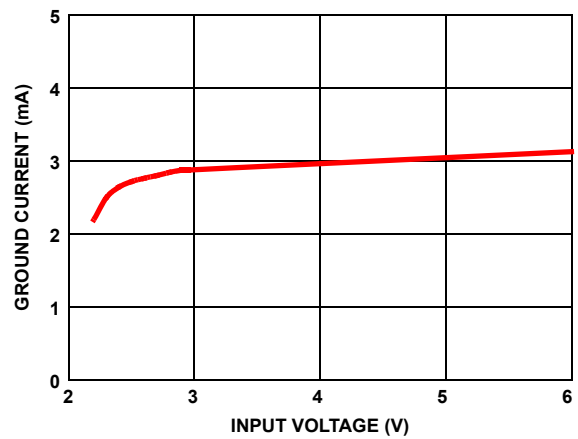

FIGURE 8. GROUND CURRENT vs SUPPLY VOLTAGE

Typical Operating Performance

Unless otherwise noted: $V_{IN} = 2.2V$, $V_{OUT} = 1.8V$, $C_{IN} = C_{OUT} = 10\mu F$, $T_J = +25^\circ C$, $I_L = 0A$. (Continued)

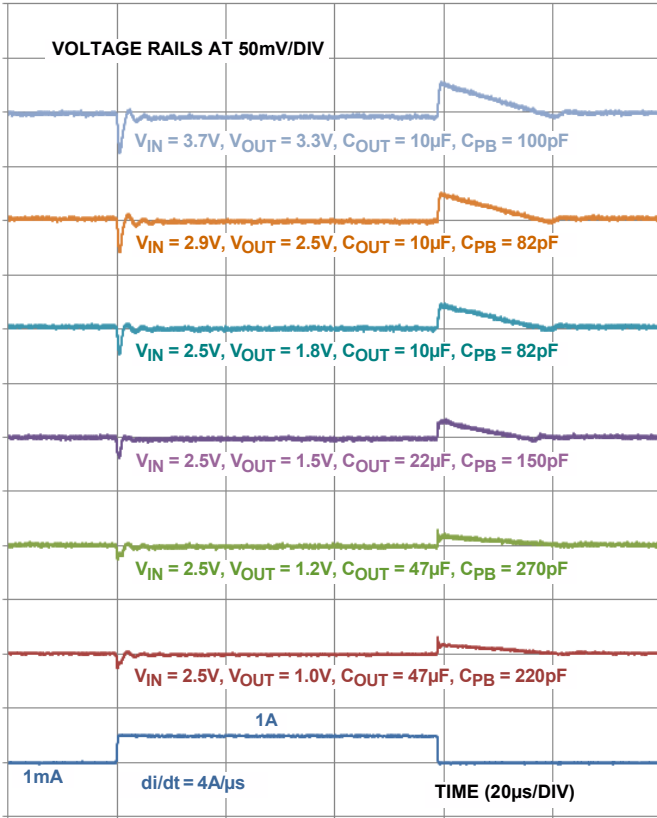

FIGURE 9. LOAD TRANSIENT RESPONSE

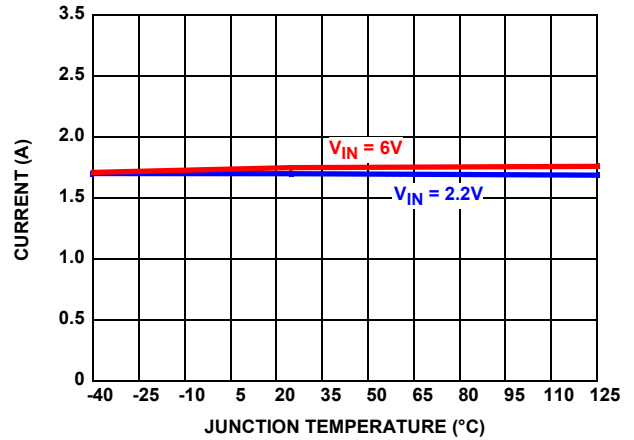

FIGURE 10. CURRENT LIMIT vs TEMPERATURE ($V_{OUT} = 0V$)

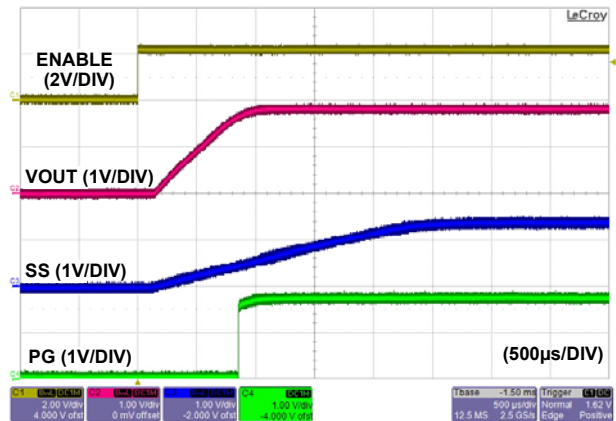

FIGURE 11. ENABLE START-UP ($C_{SS} = 2.2nF$)

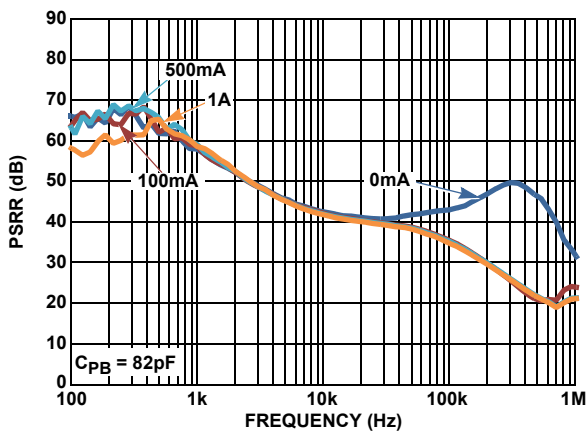

FIGURE 12. PSRR vs FREQUENCY FOR VARIOUS LOAD CURRENTS

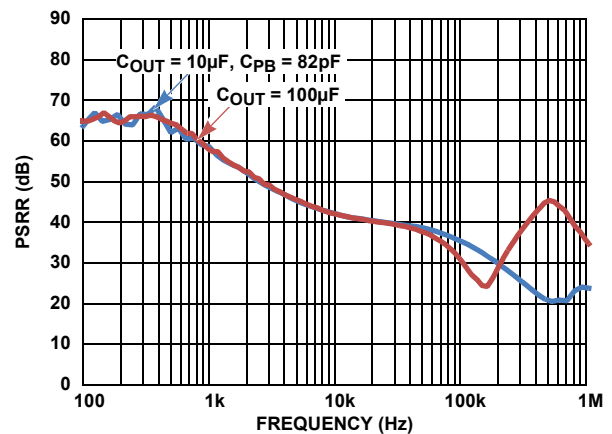

FIGURE 13. PSRR vs FREQUENCY FOR VARIOUS OUTPUT CAPACITORS ($I_{OUT} = 100mA$)

Typical Operating Performance

Unless otherwise noted: $V_{IN} = 2.2V$, $V_{OUT} = 1.8V$, $C_{IN} = C_{OUT} = 10\mu F$, $T_J = +25^\circ C$, $I_L = 0A$. (Continued)

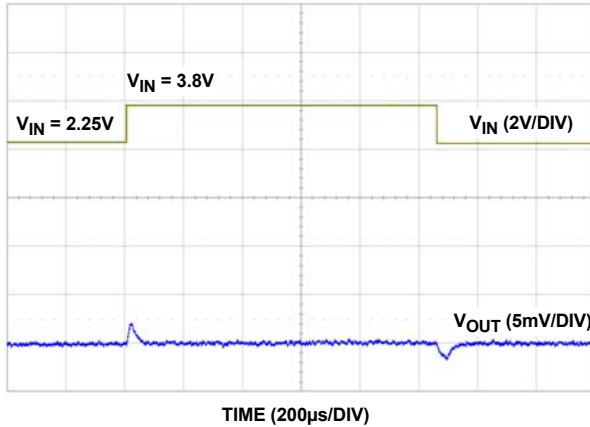

FIGURE 14. LINE TRANSIENT RESPONSE

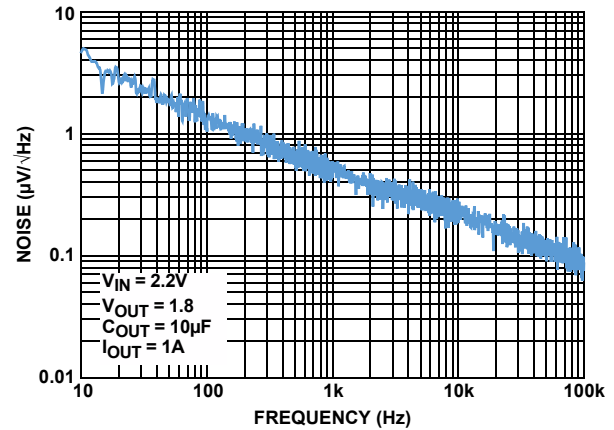

FIGURE 15. OUTPUT NOISE SPECTRAL DENSITY

Applications Information

Input Voltage Requirements

ISL80101-ADJ is capable of delivering output voltages from 0.8V to 5.0V. Due to the nature of an LDO, V_{IN} must be some margin higher than V_{OUT} plus dropout at the maximum rated current of the application if active filtering (PSRR) is expected from V_{IN} to V_{OUT} . The very low dropout specification of this family of LDOs allows applications to design for a level of efficiency that can accommodate profiles smaller than the TO220/263.

Enable Operation

The Enable turn-on threshold is typically 800mV with 80mV of hysteresis. This pin must not be left floating, and should be tied to V_{IN} if not used. A 1k Ω to 10k Ω pull-up resistor is required for applications that use open collector or open-drain outputs to control the Enable pin. An internal pull-up or pull-down resistor to change these values is available upon request. The Enable pin may be connected directly to V_{IN} for applications with outputs that are always on.

Power-Good Operation

PG is a logic output that indicates the status of V_{OUT} . The PG flag is an open-drain NMOS that can sink up to 10mA. It requires an external pull-up resistor typically connected to the V_{OUT} pin. The PG pin should not be pulled up to a voltage source greater than V_{IN} . PG goes low when the output voltage drops below 84% of the nominal output voltage or if the part is disabled. The PG comparator functions during current limit and thermal shutdown. For applications not using this feature, connect this pin to ground.

Soft-Start Operation

The soft-start circuit controls the rate at which the output voltage rises up to regulation at power-up or LDO enable. This start-up ramp time can be set by adding an external capacitor from the SS pin to ground. An internal 2 μA current source charges up this C_{SS} and the feedback reference voltage is clamped to the voltage across it. The start-up time is set by [Equation 1](#).

$$T_{start} = \frac{C_{SS} \times 0.5}{2\mu A} \quad (\text{EQ. 1})$$

[Equation 2](#) determines the C_{SS} required for a specific start-up in-rush current, where V_{OUT} is the output voltage, C_{OUT} is the total capacitance on the output and I_{INRUSH} is the desired in-rush current.

$$C_{SS} = \frac{V_{OUT} \times C_{OUT} \times 2\mu A}{I_{INRUSH} \times 0.5V} \quad (\text{EQ. 2})$$

The external capacitor is always discharged to ground at the beginning of start-up or enabling.

Output Voltage Selection

An external resistor divider, R_1 and R_2 as referenced in [Figure 1 on page 1](#), is used to scale the output voltage relative to the internal reference voltage. The output voltage can be programmed to any level between 0.8V and 5V. The recommended value for R_2 is 500 Ω to 5k Ω . R_1 is then chosen to satisfy [Equation 3](#).

$$V_{OUT} = 0.5V \times \left(\frac{R_2}{R_1} + 1 \right) \quad (\text{EQ. 3})$$

External Capacitor Requirements

External capacitors are required for proper operation. Careful attention must be paid to the layout guidelines and selection of capacitor type and value to ensure optimal performance.

OUTPUT CAPACITOR

The ISL80101-ADJ applies state-of-the-art internal compensation to keep the selection of the output capacitor simple for the customer. Stable operation over full temperature, V_{IN} range, V_{OUT} range and load extremes are guaranteed for all capacitor types and values assuming the minimum recommended ceramic capacitor is used for local bypass on V_{OUT} . There is a growing trend to use very-low ESR multilayer ceramic capacitors (MLCC) because they can support fast load transients and also bypass very high frequency noise from other sources. However, the effective capacitance of MLCCs drops with applied voltage, age,

and temperature. X7R and X5R dielectric ceramic capacitors are strongly recommended as they typically maintain a capacitance range within $\pm 20\%$ of nominal voltage over full operating ratings of temperature and voltage. This output capacitor must be connected to the V_{OUT} and GND pins of the LDO with PCB traces no longer than 0.5cm.

Additional capacitors of any value in ceramic, POSCAP, alum/tantalum electrolytic types may be placed in parallel to improve PSRR at higher frequencies and/or load transient AC output voltage tolerances. The use of C_{PB} (see following section) is recommended when only the minimum recommended ceramic capacitor is used on the output. Please refer to [Table 2](#) for these minimum conditions for various output voltages.

Phase Boost Capacitor

A small phase boost capacitor, C_{PB} , can be placed across the top resistor, R_2 , in the feedback resistor divider network in order to place a zero at:

$$f_z = \frac{1}{2\pi \times R_2 \times C_{PB}} \quad (\text{EQ. 4})$$

This zero increases the crossover frequency of the LDO and provides additional phase resulting in faster load transient response.

It is important to note that LDO stability and load transient performance are affected by the type of output capacitor used. For optimal result, empirical tuning of C_{PB} is suggested for each specific application. It is recommended to not use C_{PB} when high ESR capacitors such as Aluminum Electrolytic or Tantalum are used on the output.

[Table 2](#) shows the recommended minimum ceramic C_{OUT} and corresponding C_{PB} , R_2 and R_1 for different output voltages.

TABLE 2. RECOMMENDED C_{PB} FOR DIFFERENT V_{OUT} AND C_{OUT}

V_{OUT} (V)	R_2 (k Ω)	R_1 (k Ω)	C_{OUT} (μ F)	C_{PB} (pF)
5.0	2.61	0.287	10	100
3.3	2.61	0.464	10	100
2.5	2.61	0.649	10	82
1.8	2.61	1.0	10	82
1.5	2.61	1.3	10	68
1.5	2.61	1.3	22	150
1.2	2.61	1.87	22	120
1.2	2.61	1.87	47	270
1.0	2.61	2.61	47	220
0.8	2.61	4.32	47	220

INPUT CAPACITOR

For proper operation, a minimum capacitance of 10 μ F X5R/X7R is required at the input. This ceramic input capacitor must be connected to the V_{IN} and GND pins of the LDO with PCB traces no longer than 0.5cm.

Power Dissipation and Thermals

The junction temperature must not exceed the range specified in the "Recommended Operating Conditions" on [page 4](#). The power dissipation can be calculated by using [Equation 5](#):

$$P_D = (V_{IN} - V_{OUT}) \times I_{OUT} + V_{IN} \times I_{GND} \quad (\text{EQ. 5})$$

The maximum allowable junction temperature, $T_{J(MAX)}$ and the maximum expected ambient temperature, $T_{A(MAX)}$ determine the maximum allowable power dissipation, as shown in [Equation 6](#):

$$P_{D(MAX)} = (T_{J(MAX)} - T_A) / \theta_{JA} \quad (\text{EQ. 6})$$

θ_{JA} is the junction-to-ambient thermal resistance.

For safe operation, ensure that the power dissipation P_D , calculated from [Equation 5](#), is less than the maximum allowable power dissipation $P_{D(MAX)}$.

The DFN package uses the copper area on the PCB as a heatsink. The EPAD of this package must be soldered to the copper plane (GND plane) for effective heat dissipation. [Figure 16](#) shows a curve for the θ_{JA} of the DFN package for different copper area sizes.

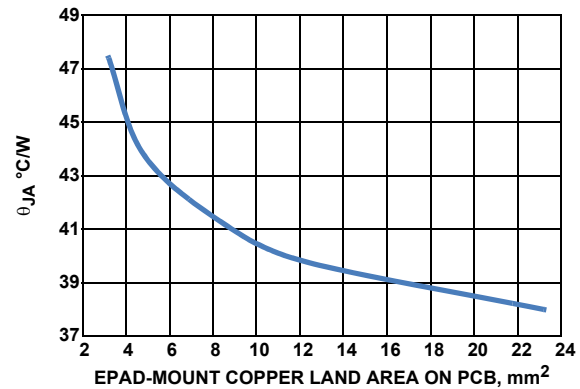

FIGURE 16. 3mmx3mm 10-PIN DFN ON 4-LAYER PCB WITH THERMAL VIAS θ_{JA} vs EPAD-MOUNT COPPER LAND AREA ON PCB

Thermal Fault Protection

The power level and the thermal impedance of the package (+45° C/W for DFN) determine when the junction temperature exceeds the thermal shutdown temperature. In the event that the die temperature exceeds around +160°C, the output of the LDO will shut down until the die temperature cools down to about +130°C.

Current Limit Protection

The ISL80101-ADJ LDO incorporates protection against overcurrent due to any short or overload condition applied to the output pin. The LDO performs as a constant current source when the output current exceeds the current limit threshold noted in the "Electrical Specifications" table on [page 4](#). If the short or overload condition is removed from V_{OUT} , then the output returns to normal voltage regulation mode. In the event of an overload condition, the LDO may begin to cycle on and off due to the die temperature exceeding thermal fault condition and subsequently cooling down after the power device is turned off.

Revision History

The revision history provided is for informational purposes only and is believed to be accurate, but not warranted. Please go to web to make sure you have the latest revision.

DATE	REVISION	CHANGE
August 26, 2015	FN7834.3	<p>Added Related Literature to page 1.</p> <p>Removed 1st bullet in Features on page 1 which read $\pm 0.2\%$ initial V_{OUT} accuracy.</p> <p>Changed 7th bullet in Features on page 1 from Excellent 58dB PSRR at 1kHz to Excellent 65dB PSRR</p> <p>Updated the EA amp in the "Block Diagram" on page 2 by switching the + and - terminals. The positive terminal is now connected to the ADJ pin. Removed "SENSE" pin Reference in diagram</p> <p>"Pin Descriptions" on page 3 - Removed "minimum 10μF" from 1st sentence in V_{OUT} description.</p> <p>"Absolute Maximum Ratings" on page 4 - Removed Machine Model and changed latch up from +85°C to +125°C.</p> <p>Removed "SENSE" from "ADJ" in "Recommended Operating Conditions" on page 4.</p> <p>Added "$V_{IN} =$" to values in Figure 10 on page 7</p> <p>Changed Title of Figure 3 on page 6 from Dropout vs Temperature to Dropout Voltage vs Temperature</p> <p>Changed Title in Figure 12 on page 7 from PSRR vs Frequency and Load Current to PSRR vs Frequency for various load currents</p> <p>Changed Title in Figure 13 on page 7 from PSRR vs Frequency and Output Capacitance ($I_{OUT} = 100\text{mA}$) to PSRR vs Frequency for various output capacitors ($I_{OUT}=100\text{mA}$)</p> <p>Electrical Spec changes:</p> <p>Electrical Spec Table conditions on page 4 changed: $V_{IN} = V_{OUT} + 0.4\text{V}$, $V_{OUT} = 1.8\text{V}$, $C_{IN} = C_{OUT} = 2.2\mu\text{F}$, to: $2.2\text{V} < V_{IN} < 6\text{V}$, $V_{OUT} = 0.5\text{V}$</p> <p>"Feedback Pin (ADJ Option Only)" Test Conditions changed from: $2.2\text{V} \leq V_{IN} \leq 6\text{V}$, $0\text{A} < I_{LOAD} < 1\text{A}$ to: $V_{OUT} + 0.4\text{V} < V_{IN} < 6\text{V}$, $V_{OUT} = 2.5\text{V}$, $0\text{A} < I_{LOAD} < 1\text{A}$</p> <p>"DC Input Line Regulation" on page 4 - changed symbol from $\Delta V_{OUT}/\Delta V_{IN}$ to V_{OUT} low line - V_{OUT} high line)/V_{OUT} low line and added MIN -1. Test Conditions changed from: $V_{OUT} + 0.5\text{V} < V_{IN} < 5\text{V}$ to: $V_{OUT} + 0.4\text{V} < V_{IN} < 6\text{V}$, $V_{OUT} = 2.5\text{V}$</p> <p>"DC Output Load Regulation" on page 4 - changed symbol from $\Delta V_{OUT}/\Delta I_{OUT}$ to V_{OUT} no load-V_{OUT} high load)/V_{OUT} no load and added MAX 1. Test Conditions changed from: $0\text{A} < I_{LOAD} < 1\text{A}$, All voltage options to: $0\text{A} < I_{LOAD} < 1\text{A}$, $V_{OUT} = 2.5\text{V}$</p> <p>Ground Pin Current Test Conditions changed from: $I_{LOAD} = 0\text{A}$, $2.2\text{V} < V_{IN} < 6\text{V}$ to: $I_{LOAD} = 0\text{A}$, $V_{OUT} + 0.4\text{V} < V_{IN} < 6\text{V}$, $V_{OUT} = 2.5\text{V}$ $I_{LOAD} = 1\text{A}$, $2.2\text{V} < V_{IN} < 6\text{V}$ to: $I_{LOAD} = 1\text{A}$, $V_{OUT} + 0.4\text{V} < V_{IN} < 6\text{V}$, $V_{OUT} = 2.5\text{V}$</p> <p>Output Short Circuit Current Test Conditions changed from: $V_{OUT} = 0\text{V}$, $2.2\text{V} < V_{IN} < 6\text{V}$ to: $V_{OUT} = 0\text{V}$</p> <p>Thermal Shutdown Temperature, Thermal Shutdown Hysteresis, Turn-on Threshold and Hysteresis - Removed Test Conditions</p> <p>Removed "Rising Threshold" from "Thermal Shutdown Hysteresis" on page 4 and from "Hysteresis" on page 5</p> <p>"AC CHARACTERISTICS" on page 4 in PSRR - changed TYP from "72" to "65" for $f = 120\text{Hz}$. Added to Test Conditions: $V_{OUT} = 1.8\text{V}$</p> <p>Output Noise Voltage in test conditions changed "10Hz" to "100Hz", added $V_{IN} = 2.2\text{V}$, $V_{OUT} = 1.8\text{V}$. Changed TYP from "63" to "53"</p> <p>"PG Flag Low Voltage" on page 5 changed in test conditions - $V_{IN} = 2.5\text{V}$ TO $V_{IN} = 3\text{V}$</p> <p>"Turn-on Threshold" on page 5 changed MIN from: 0.3; to: 0.5</p> <p>"Hysteresis" on page 5 changed in test conditions from: $2.2\text{V} < V_{OUT} + 0.4\text{V} < 6\text{V}$, to: $2.2\text{V} < V_{IN} < 6\text{V}$</p> <p>"ENABLE Pin Leakage Current" on page 5 changed "Enable = 3V" to "Enable = 2.8V"</p> <hr/> <p>Updated Output Spectral Noise Density (Figure 15 on page 8) and changed $I_L = 1\text{A}$ to $I_{OUT} = 1\text{A}$</p> <p>Updated POD L10.3x3 to most recent revision with changes as follows: Added missing dimension 0.415 in Typical Recommended land pattern. Shortened the e-pad rectangle on both the recommended land pattern and the package bottom view to line up with the centers of the corner pins. Tiebar Note 4 updated From: Tiebar shown (if present) is a non-functional feature. To: Tiebar shown (if present) is a non-functional feature and may be located on any of the 4 sides (or ends).</p>

Revision History

The revision history provided is for informational purposes only and is believed to be accurate, but not warranted. Please go to web to make sure you have the latest revision. (Continued)

DATE	REVISION	CHANGE
July 31, 2014	FN7834.2	Updated the "Block Diagram" on page 2 reversed the + and - terminals on the EA amp. The inverting terminal is now connected to the Adj/Sense pin. Updated About Intersil verbiage to new standard. Updated "Package Outline Drawing" on page 12 to latest revision.
August 3, 2011	FN7834.1	PAGE 1 1. Introduction, paragraph 1: Last two sentences removed, and replaced with: "The ISL80101-ADJ features an adjustable output. For the fixed output version of the ISL80101, please refer to the ISL80101 datasheet." 2. Table 1: Replaced Table 1 with Table 1 from FN6931 to include the "ADJ or Fixed VOUT" column and "ISL80101-ADJ" row. 3. Features: "Available in a 10 Ld DFN Package" has "TO220-5, TO263-5 and SOT223-5 to follow soon" removed. PAGE 5 1. Enable Pin Characteristics a. "Enable Pin Turn-on Delay" changed to "ENABLE Pin Turn-on Delay" b. "Enable Pin Leakage Current" changed to "ENABLE Pin Leakage Current" PAGE 7 Figure 9: Timescale changed from "20µs/DIV" to "TIME (20µs/DIV)" PAGE 8 2. Equation 1 - Parentheses deleted. 3. Equation 2 - Parentheses deleted.
March 31, 2011	FN7834.0	Initial Release.

About Intersil

Intersil Corporation is a leading provider of innovative power management and precision analog solutions. The company's products address some of the largest markets within the industrial and infrastructure, mobile computing and high-end consumer markets.

For the most updated datasheet, application notes, related documentation and related parts, please see the respective product information page found at www.intersil.com.

You may report errors or suggestions for improving this datasheet by visiting www.intersil.com/ask.

Reliability reports are also available from our website at www.intersil.com/support.

© Copyright Intersil Americas LLC 2011-2015. All Rights Reserved.
All trademarks and registered trademarks are the property of their respective owners.

For additional products, see www.intersil.com/en/products.html

Intersil products are manufactured, assembled and tested utilizing ISO9001 quality systems as noted in the quality certifications found at www.intersil.com/en/support/qualandreliability.html

Intersil products are sold by description only. Intersil may modify the circuit design and/or specifications of products at any time without notice, provided that such modification does not, in Intersil's sole judgment, affect the form, fit or function of the product. Accordingly, the reader is cautioned to verify that datasheets are current before placing orders. Information furnished by Intersil is believed to be accurate and reliable. However, no responsibility is assumed by Intersil or its subsidiaries for its use; nor for any infringements of patents or other rights of third parties which may result from its use. No license is granted by implication or otherwise under any patent or patent rights of Intersil or its subsidiaries.

For information regarding Intersil Corporation and its products, see www.intersil.com

Package Outline Drawing L10.3x3

10 LEAD DUAL FLAT PACKAGE (DFN)

Rev 11, 3/15

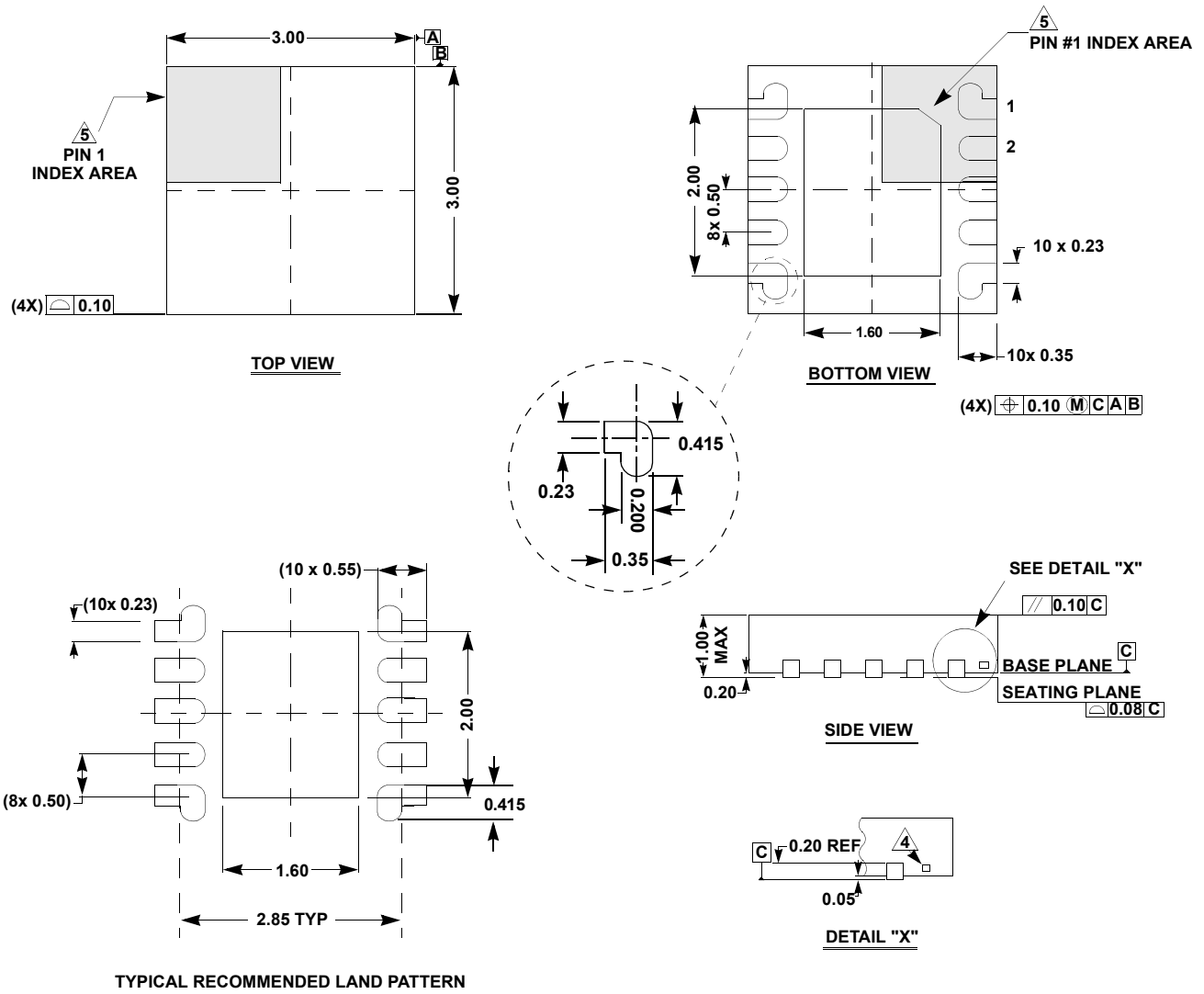

NOTES:

1. Dimensions are in millimeters.
Dimensions in () for Reference Only.
2. Dimensioning and tolerancing conform to ASME Y14.5m-1994.
3. Unless otherwise specified, tolerance : Decimal ± 0.05
4. Tiebar shown (if present) is a non-functional feature and may be located on any of the 4 sides (or ends).
5. The configuration of the pin #1 identifier is optional, but must be located within the zone indicated. The pin #1 identifier may be either a mold or mark feature.