

Local/Remote Thermal Supervisor

Features

- Measures Local and Remote Temperatures
- Pin and Software Backward Compatible to LM75
- 9-Bit Sigma-Delta ADC
- 2-Wire I²C/SMBus Compatible Interface
- Programmable Thermostatic Settings for Either Internal or External Zone
- Open-Drain Comparator/Interrupt Output Pin
- Interrupt Mask and Status Bits
- Low-Power Shutdown Mode
- Fail-Safe Response to Diode Faults
- 2.7V to 5.5V Power Supply Range
- Up to Eight Devices May Share the Same Bus
- 8-Lead SOIC and MSOP Packages

Applications

- Desktop, Server, and Notebook Computers
- Printers and Copiers
- Test and Measurement Equipment
- Consumer Electronics

General Description

The MIC184 is a versatile digital thermal supervisor capable of measuring temperature using either its own internal sensor or an inexpensive external sensor. A 2-wire serial interface is provided to allow communication with either I²C or SMBus hosts. This device is a pin-for-pin and software compatible upgrade for the industry standard LM75.

Additional features include remote temperature measurement capability, and interrupt status and mask bits in the chip's configuration register for software polling. The open-drain interrupt output pin can be used as either an overtemperature alarm or thermostatic control signal. Three programmable address pins permit users to multi-drop up to eight devices along the 2-wire bus, allowing simple distributed temperature sensing networks. Superior performance, low power and small size makes the MIC184 an excellent choice for the most demanding thermal management applications.

Package Types

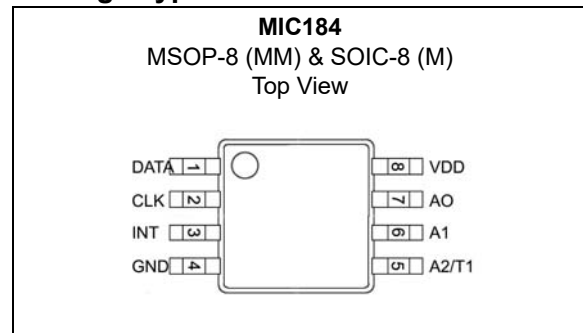

MIC184

Typical Application Circuit

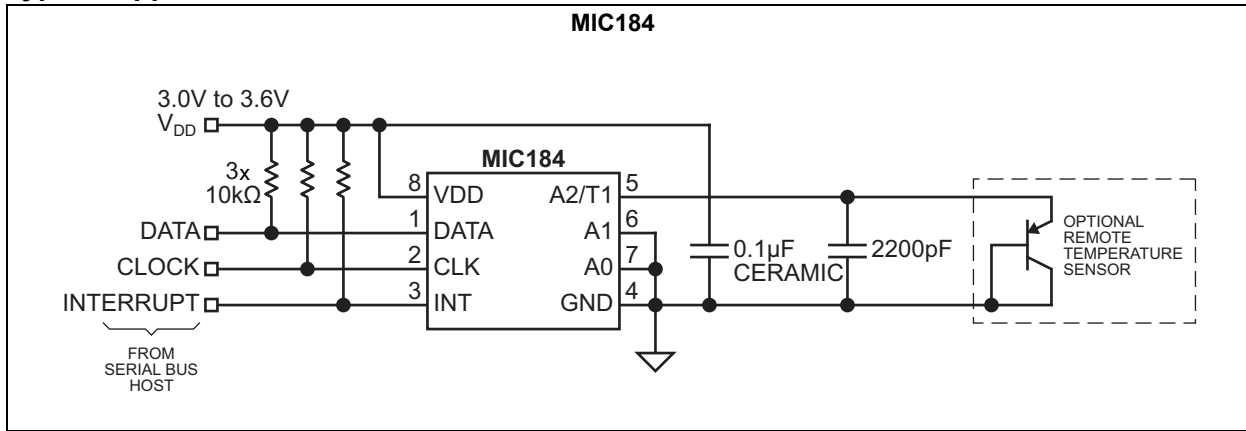

Functional Block Diagram

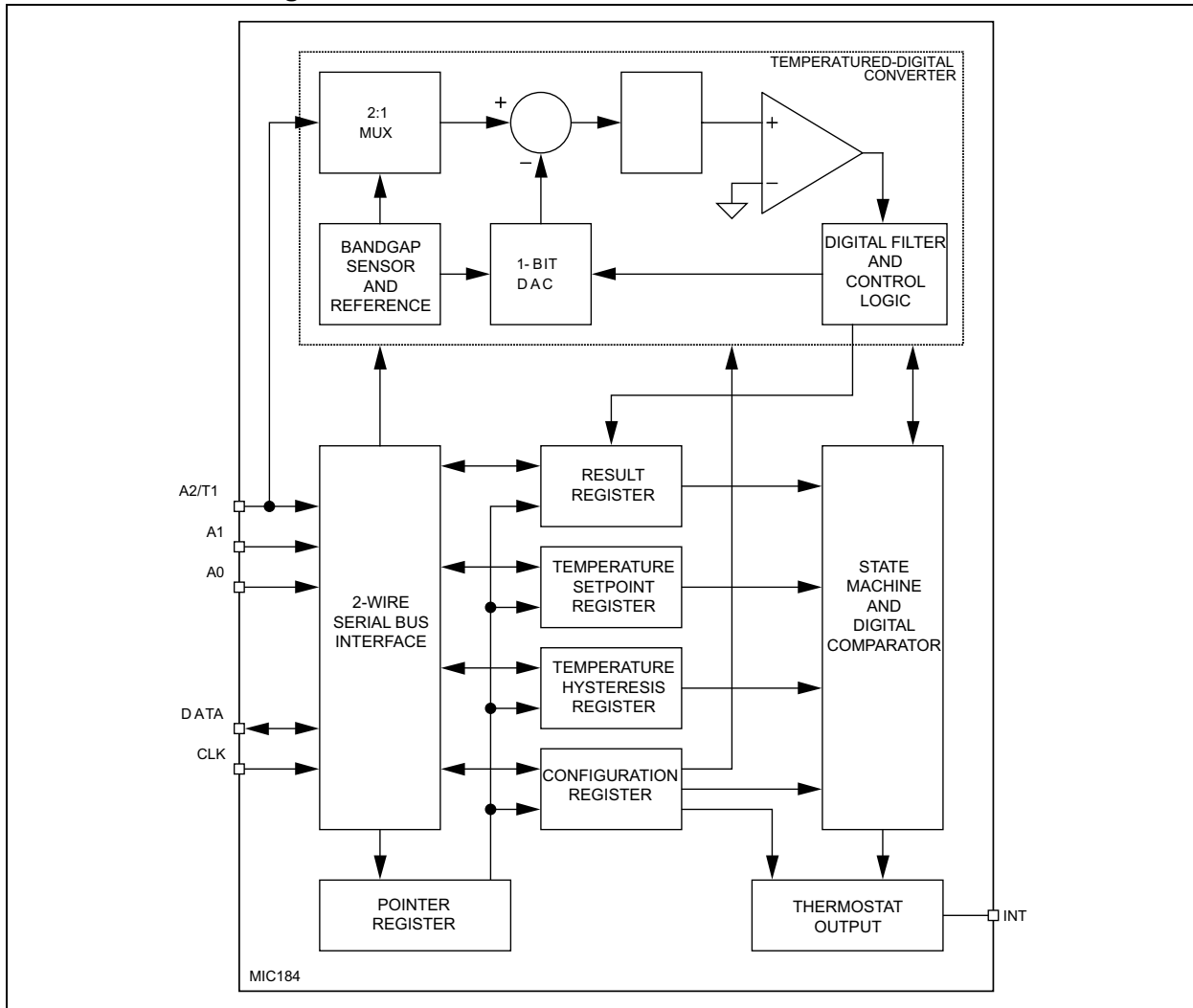

1.0 ELECTRICAL CHARACTERISTICS

Absolute Maximum Ratings

Power Supply Voltage, V_{DD}	+6.0V
Voltage on Any Pin	-0.3V to $V_{DD} + 0.3V$
Current into Any Pin	± 6 mA
Power Dissipation, $T_A = 125^\circ\text{C}$	30 mW
ESD Protection On All Pins (Note 1)	+700V HBM, +100V MM

Operating Ratings †

Power Supply Voltage, V_{DD}	+2.7V to +5.5V
--------------------------------------	----------------

† **Notice:** Guaranteed by design over the operating temperature range. Not 100% production tested.

Note 1: Devices are ESD sensitive. Handling precautions recommended. Human body model: 1.5k Ω in series with 100 pF. Machine model: 200 pF, no series resistance.

ELECTRICAL CHARACTERISTICS

Electrical Characteristics: Unless otherwise indicated, $2.7V \leq V_{DD} \leq 5.5$; values indicate $-55^\circ\text{C} \leq T_A \leq +125^\circ\text{C}$.						
Parameters	Sym.	Min.	Typ.	Max.	Units	Conditions
Power Supply						
Supply Current	I_{DD}	—	340	500	μA	INT open, A2, A1, A0 = V_{DD} or GND, CLK = DATA = high, normal mode
		—	2.5	—	μA	Shutdown mode, CLK = 100 kHz
		—	1	10	μA	INT open, A2, A1, A0 = V_{DD} or GND, CLK = DATA = high, shutdown mode
Power-On Reset Time	t_{POR}	—	15	100	μs	$V_{DD} > V_{POR}$
Power-On Reset Voltage	V_{POR}	—	2.0	2.7	V	All registers reset to default values, A/D conversions initiated
Power-On Reset Hysteresis Voltage	V_{HYST}	—	250	—	mV	$T_A = 25^\circ\text{C}$
Temperature-to-Digital Converter Characteristics						
Accuracy—Local Temperature (Note 1, 2)	—	—	± 1	± 2	$^\circ\text{C}$	$0^\circ\text{C} \leq T_A \leq +100^\circ\text{C}$, INT open, $3V \leq V_{DD} \leq 3.6V$
	—	—	± 2	± 3	$^\circ\text{C}$	$-55^\circ\text{C} \leq T_A \leq +125^\circ\text{C}$, INT open, $3V \leq V_{DD} \leq 3.6V$

- 1: Accuracy specification does not include quantization noise, which may be as great as $\pm 1/2\text{LSB}$ ($\pm 1/4^\circ\text{C}$).
- 2: T_D is the temperature of the remote diode junction. Testing is performed using a single unit of one of the transistors listed in Table 6-1.
- 3: Current into the INT pin will result in self-heating of the MIC184. INT pin current should be minimized for best accuracy.
- 4: This is the decimal representation of a binary data value.
- 5: Guaranteed by design over the operating temperature range. Not 100% production tested.

MIC184

ELECTRICAL CHARACTERISTICS (CONTINUED)

Electrical Characteristics: Unless otherwise indicated, $2.7V \leq V_{DD} \leq 5.5$; values indicate $-55^{\circ}C \leq T_A \leq +125^{\circ}C$.						
Parameters	Sym.	Min.	Typ.	Max.	Units	Conditions
Accuracy—Remote Temperature (Note 1, 2)	—	—	± 1	± 3	$^{\circ}C$	$0^{\circ}C \leq T_D \leq +100^{\circ}C$, INT open, $3V \leq V_{DD} \leq 3.6V$, $0^{\circ}C \leq T_A \leq 85^{\circ}C$
	—	—	± 2	± 5	$^{\circ}C$	$-55^{\circ}C \leq T_D \leq +125^{\circ}C$, INT open, $3V \leq V_{DD} \leq 3.6V$, $0^{\circ}C \leq T_A \leq +85^{\circ}C$
Conversion Time, (Note 1)	t_{CONV}	—	100	160	ms	Local temperature
		—	200	320	ms	Remote temperature
Remote Temperature Input (T1)						
Current to External Diode (Note 1)	I_F	—	224	400	μA	High level
		7.5	14	—	μA	Low level
Address Inputs (A2/T1, A1, A0)						
Low Input Voltage	V_{IL}	—	—	0.6	V	$2.7V \leq V_{DD} \leq 5.5V$
High Input Voltage	V_{IH}	2.0	—	—	V	$2.7V \leq V_{DD} \leq 5.5V$
Input Capacitance	C_{IN}	—	10	—	pF	—
Input Current	I_{LEAK}	—	± 0.01	± 1	μA	—
Pull-down Current On A2/T1	I_{PD}	—	25	—	μA	A2 = V_{DD} , flows for t_{POR} at power-up
Serial Data I/O Pin (DATA)						
Low Output Voltage	V_{OL}	—	—	0.4	V	$I_{OL} = 3\text{ mA}$
		—	—	0.8	V	$I_{OL} = 6\text{ mA}$
Low Input Voltage	V_{IL}	—	—	$0.3V_{DD}$	V	$2.7V \leq V_{DD} \leq 5.5V$
High Input Voltage	V_{IH}	$0.7V_{DD}$	—	—	V	$2.7V \leq V_{DD} \leq 5.5V$
Input Capacitance	C_{IN}	—	10	—	pF	—
Input Current	I_{LEAK}	—	± 0.01	± 1	μA	—
Serial Clock Input (CLK)						
Low Input Voltage	V_{IL}	—	—	$0.3V_{DD}$	V	$2.7V \leq V_{DD} \leq 5.5V$
High Input Voltage	V_{IH}	$0.7V_{DD}$	—	—	V	$2.7V \leq V_{DD} \leq 5.5V$
Input Capacitance	C_{IN}	—	10	—	pF	—
Input Current	I_{LEAK}	—	± 0.01	± 1	μA	—
Status Output (INT)						
Low Output Voltage, (Note 3)	V_{OL}	—	—	0.4	V	$I_{OL} = 3\text{ mA}$
		—	—	0.8	V	$I_{OL} = 6\text{ mA}$

- 1: Accuracy specification does not include quantization noise, which may be as great as $\pm 1/2\text{LSB}$ ($\pm 1/4^{\circ}C$).
- 2: T_D is the temperature of the remote diode junction. Testing is performed using a single unit of one of the transistors listed in Table 6-1.
- 3: Current into the INT pin will result in self-heating of the MIC184. INT pin current should be minimized for best accuracy.
- 4: This is the decimal representation of a binary data value.
- 5: Guaranteed by design over the operating temperature range. Not 100% production tested.

ELECTRICAL CHARACTERISTICS (CONTINUED)

Electrical Characteristics: Unless otherwise indicated, $2.7V \leq V_{DD} \leq 5.5$; values indicate $-55^{\circ}C \leq T_A \leq +125^{\circ}C$.						
Parameters	Sym.	Min.	Typ.	Max.	Units	Conditions
Interrupt Propagation Delay, (Note 1)	t_{INT}	—	—	$t_{CONV}+1$	μs	From $TEMP > T_{SET}$, $FQ = 00$ to $INT < V_{OL}$, $R_{PULLUP} = 10\ k\Omega$; $POL\ bit = 0$
Interrupt Reset Propagation Delay, (Note 1)	t_{hINT}	—	—	1	μs	From any register read to $INT > V_{OH}$, $R_{PULLUP} = 10\ k\Omega$; $POL\ bit = 0$
Default T_{SET} Value	T_{SET}	80	80	80	$^{\circ}C$	t_{POR} after $V_{DD} > V_{POR}$, (Note 4)
Default HYST Value	HYST	75	75	75	$^{\circ}C$	t_{POR} after $V_{DD} > V_{POR}$, (Note 4)
Serial Interface Timing (Note 5)						
CLK (Clock) Period	t_1	2.5	—	—	μs	—
Data In Setup Time to CLK High	t_2	100	—	—	ns	—
Data Out Stable After CLK Low	t_3	0	—	—	ns	—
DATA Low Setup Time to CLK Low	t_4	100	—	—	ns	Start condition
DATA High Hold Time After CLK High	t_5	100	—	—	ns	Stop condition

- 1: Accuracy specification does not include quantization noise, which may be as great as $\pm 1/2LSB$ ($\pm 1/4^{\circ}C$).
- 2: T_D is the temperature of the remote diode junction. Testing is performed using a single unit of one of the transistors listed in [Table 6-1](#).
- 3: Current into the INT pin will result in self-heating of the MIC184. INT pin current should be minimized for best accuracy.
- 4: This is the decimal representation of a binary data value.
- 5: Guaranteed by design over the operating temperature range. Not 100% production tested.

MIC184

TEMPERATURE SPECIFICATIONS (Note 1)

Parameters	Sym.	Min.	Typ.	Max.	Units	Conditions
Temperature Ranges						
Operating Ambient Temperature Range	T_A	-55	—	+125	°C	—
Junction Operating Temperature	T_J	—	—	+150	°C	—
Storage Temperature Range	T_S	-65	—	+150	°C	—
Soldering Temperature	—	—	+220	+225	°C	Vapor Phase, 60s
	—	—	+235	+240	°C	Infrared, 15s
Package Thermal Resistances						
Thermal Resistance, SOIC	θ_{JA}	—	+152	—	°C/W	—
Thermal Resistance, MSOP	θ_{JA}	—	+206	—	°C/W	—

Note 1: The maximum allowable power dissipation is a function of ambient temperature, the maximum allowable junction temperature and the thermal resistance from junction to air (i.e., T_A , T_J , θ_{JA}). Exceeding the maximum allowable power dissipation will cause the device operating junction temperature to exceed the maximum +150°C rating. Sustained junction temperatures above +150°C can impact the device reliability.

2.0 TYPICAL CHARACTERISTICS

Note: The graphs and tables provided following this note are a statistical summary based on a limited number of samples and are provided for informational purposes only. The performance characteristics listed herein are not tested or guaranteed. In some graphs or tables, the data presented may be outside the specified operating range (e.g., outside specified power supply range) and therefore outside the warranted range.

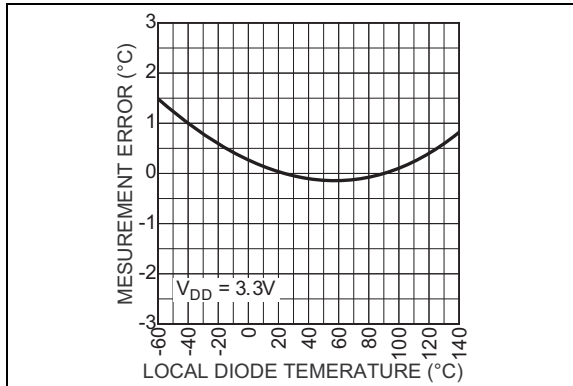

FIGURE 2-1: Local Temperature Measurement Error.

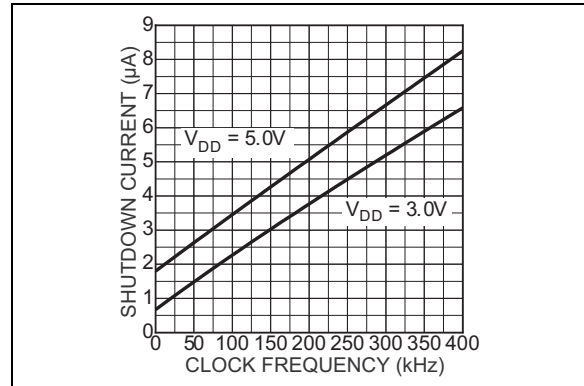

FIGURE 2-4: Shutdown I_{DD} vs. Frequency.

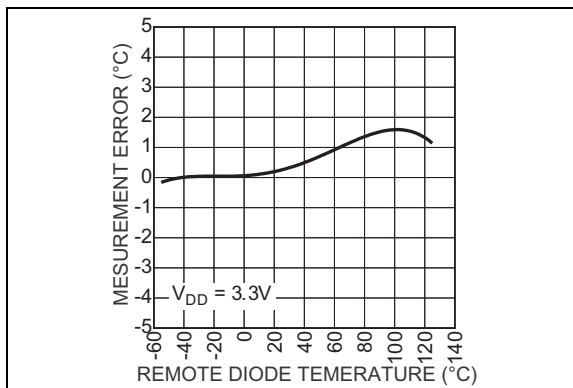

FIGURE 2-2: Remote Temperature Measurement Error.

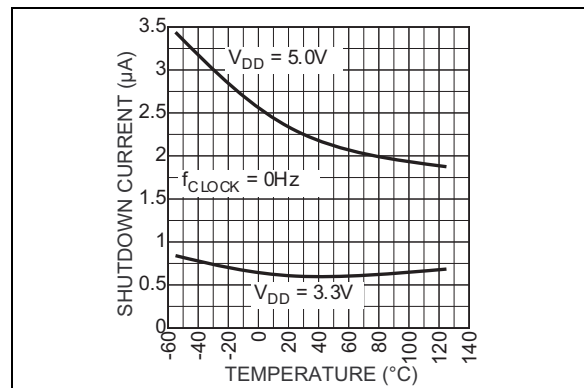

FIGURE 2-5: Shutdown I_{DD} vs. Temperature.

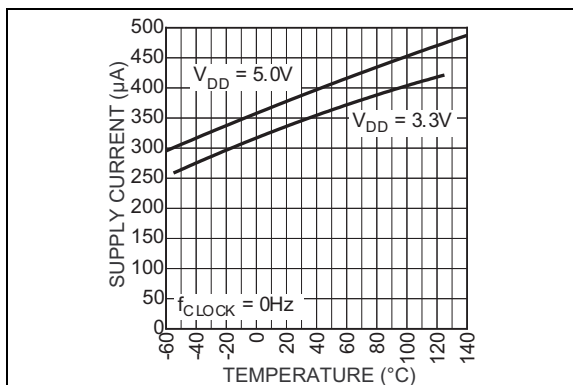

FIGURE 2-3: Operating I_{DD} vs. Temperature.

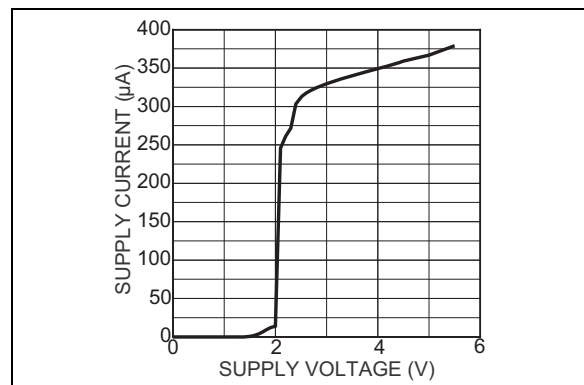

FIGURE 2-6: Supply Current vs. Supply Voltage.

MIC184

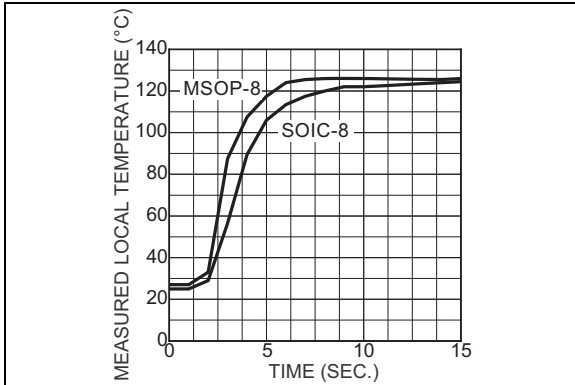

FIGURE 2-7: Response to Immersion in 125°C Fluid Bath.

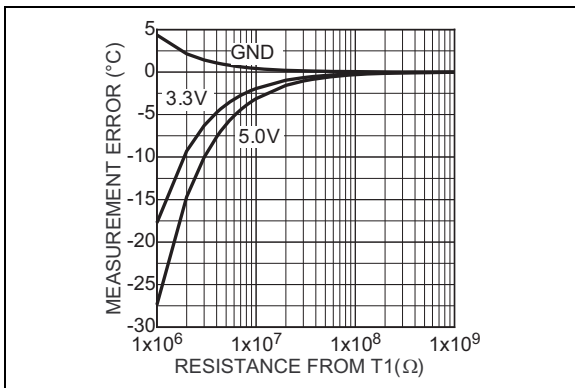

FIGURE 2-8: Measurement Error vs. PCB Leakage to +5V/+3.3V/GND.

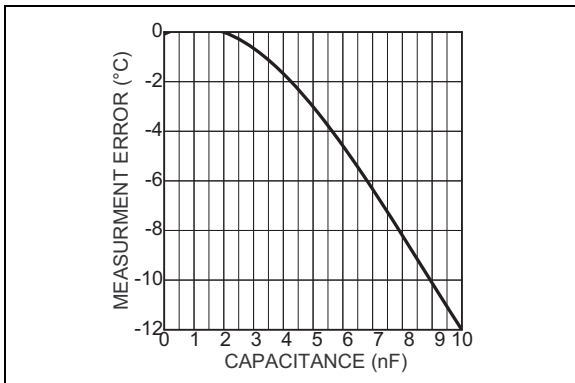

FIGURE 2-9: Measurement Error vs. Capacitance on T1.

3.0 PIN DESCRIPTIONS

The descriptions of the pins are listed in [Table 3-1](#). Pin order and descriptions apply across both package types.

TABLE 3-1: MSOP AND SOIC PACKAGE PIN FUNCTION TABLE

Pin Number	Symbol	Description
1	DATA	Data (Digital I/O): Open-drain. Serial data input/output.
2	CLK	Clock (Digital Input): The host provides the serial bit clock on this input.
3	INT	Interrupt (Digital Output): Open-drain. Interrupt or thermostat output.
4	GND	Ground: Power and signal return for all IC functions.
5	A2/T1	Address Bit 2 (Digital Input): Client address selection input. See “Table 4-1 MIC184 Client Address Settings.”
		Temperature Sensor 1 (Analog Input): Input from remote temperature sensor (diode junction).
6	A1	Address Bit 1 (Digital Input): Client address selection input. See “Table 4-1 MIC184 Client Address Truth Table.”
7	A0	Address Bit 0 (Digital Input): Client address selection input. See “Table 4-1 MIC184 Client Address Truth Table.”
8	VDD	Supply (Analog Input): Power supply input to the IC.

MIC184

4.0 FUNCTIONAL DESCRIPTION

4.1 Pin Descriptions

4.1.1 VDD

Power supply input. See [Electrical Characteristics](#).

4.1.2 GND

Ground return for all MIC184 functions.

4.1.3 CLK

Clock input to the MIC184 from the two-wire serial bus. The clock signal is provided by the bus host and is shared by all devices on the bus.

4.1.4 DATA

Serial data I/O pin that connects to the two-wire serial bus. DATA is bidirectional and has an open-drain output driver. An external pull-up resistor or current source somewhere in the system is necessary on this line. This line is shared by all devices on the bus.

4.1.5 A2/T1, A1, A0

These inputs set the three least significant bits of the MIC184's 7-bit client address. Each MIC184 will only respond to its own unique client address, allowing the use of up to eight MIC184s on a single bus. A match between the MIC184's address and the address specified in the serial bit stream must be made to initiate communication. A1 and A0 should be connected directly to VDD or ground. When A2/T1 is used as an address bit input, it should also be tied to VDD alternatively connect to a remote A2/T1 is used for temperature measurements, an off-chip diode junction must be connected between A2/T1 and ground. In this case, internal circuitry will detect A2 as logic low, leaving four possible client addresses. See [Temperature Measurement](#) and [Power-On](#) sections for more information. A2/T1, A1, and A0 determine the client address as shown in [Table 4-1](#).

4.1.6 INT

Temperature events are indicated to external circuitry via this output. INT may be configured as active-low or active-high by the host. Operation of the INT output is controlled by the MODE and POL bits in the MIC184's configuration register. See [Comparator and Interrupt Modes](#). This output is open-drain and may be wire-ORed with other open-drain signals. Most systems will require a pull-up resistor or current source on this pin. If the IM bit in the configuration register is

set, it prevents the INT output from sinking current. In I²C and SMBus systems, the IM bit is therefore an interrupt mask bit.

TABLE 4-1: MIC184 CLIENT ADDRESS SETTINGS

Inputs			MIC184 Client Address	
A2/T1	A1	A0	Binary	Hex
0	0	0	100 1000 _b	48 _h
0	0	1	100 1001 _b	49 _h
0	1	0	100 1010 _b	4A _h
0	1	1	100 1011 _b	4B _h
1	0	0	100 1100 _b	4C _h
1	0	1	100 1101 _b	4D _h
1	1	0	100 1110 _b	4E _h
1	1	1	100 1111 _b	4F _h
Diode	0	0	100 1000 _b	48 _h
Diode	0	1	100 1001 _b	49 _h
Diode	1	0	100 1010 _b	4A _h
Diode	1	1	100 1011 _b	4B _h

4.1.7 TEMPERATURE MEASUREMENT

The temperature-to-digital converter for both internal and external temperature data is built around a switched current source and a 9-bit analog-to-digital converter. The temperature is calculated by measuring the forward voltage of a diode junction at two different bias current levels. An internal multiplexer directs the current source's output to either an internal or external diode junction.

The MIC184 uses two's-complement data to represent temperatures. If the MSB of a temperature value is 0, the temperature is $\geq 0^{\circ}\text{C}$. If the MSB is 1, the temperature is $< 0^{\circ}$. More detail on this is given in [Temperature Data Format](#) below. A temperature event results if the value in the temperature result register (TEMP) is greater than the value in the overtemperature set-point register (T_SET), or if it is less than the value in the temperature hysteresis register (T_HYST).

The value of the ZONE bit in the configuration register determines whether readings are taken from the on-chip sensor or from the A2/T1 input. At power-up, the ZONE bit of the configuration register is set to zero. The MIC184 therefore monitors its internal temperature and compares the result against the contents of T_SET and T_HYST. Setting the ZONE bit in CONFIG will result in the MIC184 acquiring temperature data from an external diode connected to the A2/T1 pin. This diode may be embedded in an integrated circuit (such as a CPU, ASIC, or graphics processor), or it may be a diode-connected discrete transistor. Once the new

value is written to CONFIG, the A/D converter will begin a new conversion and return temperature data from the external zone. This data will be compared against T_SET, T_HYST, and the state of the Fault_Queue (described below). The internal status bit (STS) and the INT output will then be updated accordingly. See the [Applications Information](#) section for more details on switching between zones.

4.1.8 DIODE FAULTS

The MIC184 is designed to respond in a fail-safe manner to hardware faults in the external sensing circuitry. If the connection to the external diode is lost, or the sense line (A2/T1) is shorted to V_{DD} or ground, the temperature data reported by the A/D converter will be forced to its full-scale value (+127.5°C). This will cause an overtemperature event to occur whenever T_SET ≤ +127.0°C (0 1111 1110b). An interrupt will be generated if so enabled. The temperature reported for the external zone will remain 0 1111 1111b = +127.5°C until the fault condition is cleared. This fault detection requires that the MIC184 complete the number of conversion cycles specified by Fault_Queue. The MIC184 may therefore require one or more conversion cycles following power-on or a transition from shutdown to normal operation before reporting an external diode fault.

4.1.9 SERIAL PORT OPERATION

The MIC184 uses standard SMBus WRITE_BYTE, READ_BYTE, WRITE_WORD, and READ_WORD operations for communication with its host. The SMBus WRITE_BYTE and WRITE_WORD operations involve sending the device's client address (with the R/W bit low to signal a write operation), followed by a command byte and one or two data bytes. The SMBus READ_BYTE operation is similar, but is a composite write and read operation: the host first sends the device's client address followed by the command byte, as in a write operation. A new "start" bit must then be sent to the MIC184, followed by a repeat of the client address with the R/W bit (LSB) set to the high (read) state. The data to be read from the MIC184 may then be clocked out. There is one exception to this rule: If the location latched in the pointer register from the last write operation is known to be correct (i.e., points to the desired register), then the "RECEIVE_DATA" procedure may be used. To perform a RECEIVE_DATA, the host sends an address byte to select the client MIC184, and then retrieves the appropriate number (one or two) of data bytes. [Figure 4-1](#) through [Figure 4-5](#) show the formats for these data read and data write procedures.

The command byte is 8 bits (1 byte) wide. This byte carries the address of the MIC184 register to be operated upon, and is stored in the MIC184's pointer register. The pointer register is a write-only register, which is implemented for backward compatibility to the National Semiconductor LM75 and similar devices.

The command byte (pointer register) values corresponding to the various MIC184 register addresses are shown in [Table 4-2](#). Command byte values other than 0000 00XXb = 00h through 03h are reserved, and should not be used.

The CONFIG register is 8 bits (1 byte) wide. Therefore, communications with the CONFIG register will at a minimum require a READ_BYTE, WRITE_BYTE, or a RECEIVE_BYTE.

The TEMP, T_HYST, and T_SET registers are logically nine bits wide. Note, though, that these registers are physically two bytes (one SMBus word) wide within the MIC184. Properly communicating with the MIC184 involves a 16-bit READ_WORD or RECEIVE_WORD from, or WRITE_WORD to, these registers. This is a requirement of the I²C/SMBus serial data protocols, which only allow data transfers to occur in multiples of eight bits.

TABLE 4-2: MIC184 REGISTER ADDRESSES

Command_Byte		Target Register	
Binary	Hex	Label	Description
0000 0000 _b	00 _h	TEMP	Measured temperature result
0000 0001 _b	01 _h	CONFIG	Configuration register
0000 0010 _b	02 _h	T_HYST	Temperature hysteresis
0000 0011 _b	03 _h	T_SET	Overtemperature set point
0000 0100 _b	04 _h	RESERVED	DO NOT USE
—	—		
—	—		
1111 1111 _b	FF _h		

4.1.10 TEMPERATURE DATA FORMAT

The LSB of each 9-bit logical register represents 0.5°C. The values are in a two's complement format, wherein the most significant bit (D8) represents the sign: "0" for positive temperatures and "1" for negative temperatures. The seven least significant bits of each 16-bit physical register are undefined. Therefore, physical bits D6 through D0 of the data read from these registers must be masked off, and the resulting binary value right justified before using the data received. It is also possible to read only the first byte of any of these three registers, sacrificing 0.5°C of resolution in exchange for somewhat simpler data handling. However, all writes to the T_SET and T_HYST registers must be in the 16-bit WRITE_WORD format. [Table 4-3](#) shows examples of the data format used by the MIC184 for temperatures.

MIC184

TABLE 4-3: DIGITAL TEMPERATURE FORMAT

Temperature	Raw Binary	Masked Binary	Masked Hex
+125 °C	0111 1101 0XXX XXXX	0 1111 1010 _b	0FA _h
+25 °C	0001 1001 0XXX XXXX	0 0011 0010 _b	032 _h
+0.5 °C	0000 0000 1XXX XXXX	0 0000 0001 _b	001 _h
0 °C	0000 0000 0XXX XXXX	0 0000 0000 _b	000 _h
-0.5 °C	1111 1111 1XXX XXXX	1 1111 1111 _b	1FF _h
-25 °C	1110 0111 0XXX XXXX	1 1100 1110 _b	1CE _h
-40 °C	1101 1000 0XXX XXXX	1 1011 0000 _b	1B0 _h
-55 °C	1100 1001 0XXX XXXX	1 1001 0010 _b	192 _h

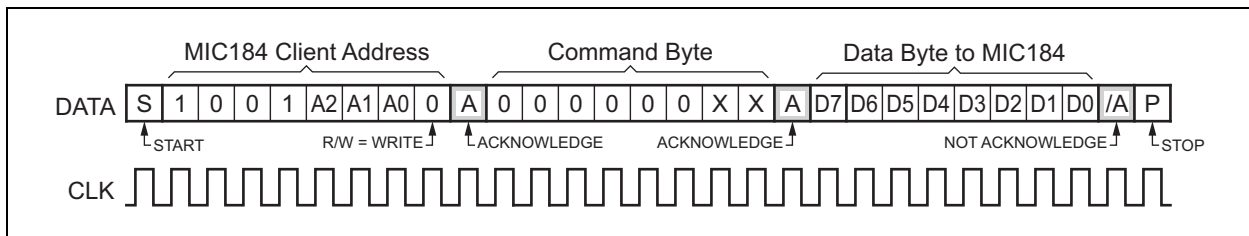

FIGURE 4-1: WRITE_BYTE Protocol.

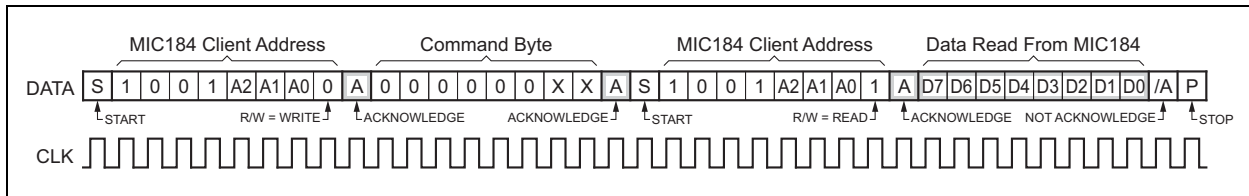

FIGURE 4-2: READ_BYTE Protocol.

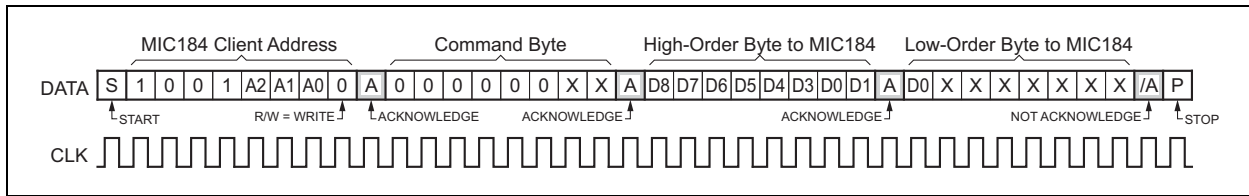

FIGURE 4-3: Write_WORD Protocol.

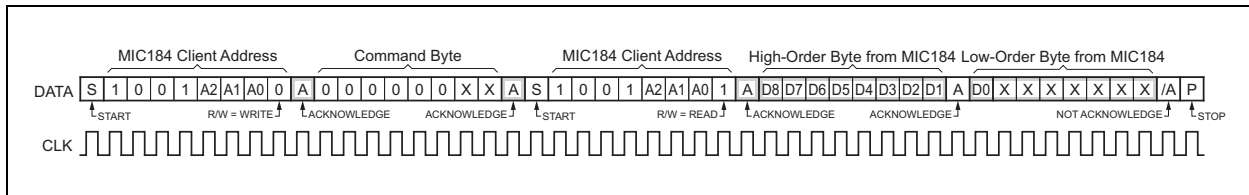

FIGURE 4-4: Read_Word Protocol.

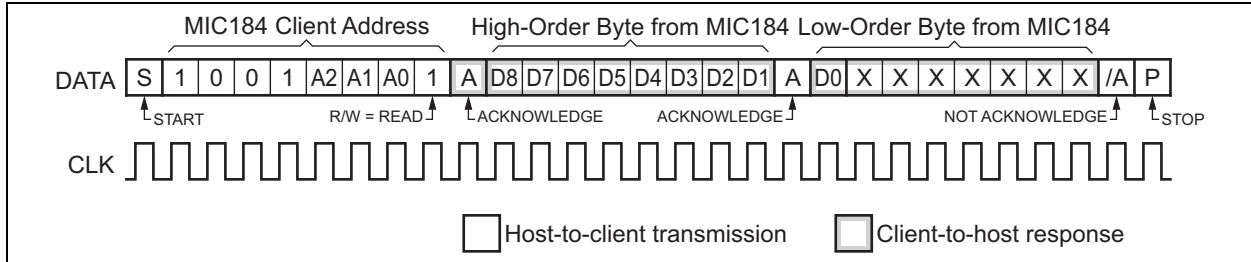

FIGURE 4-5: RECEIVE_DATA from a 16-Bit Register.

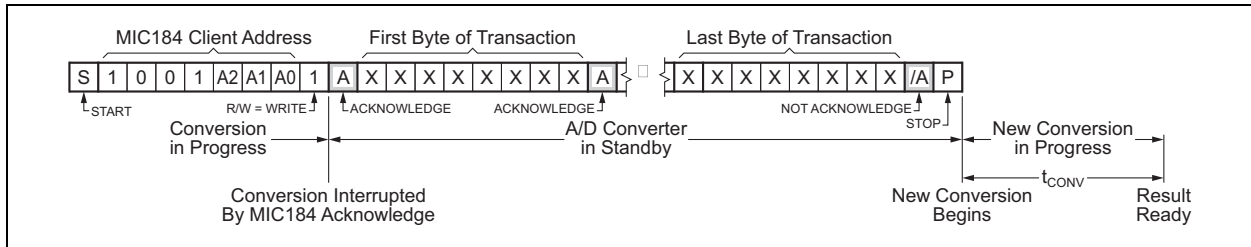

FIGURE 4-6: A/D Converter Timing.

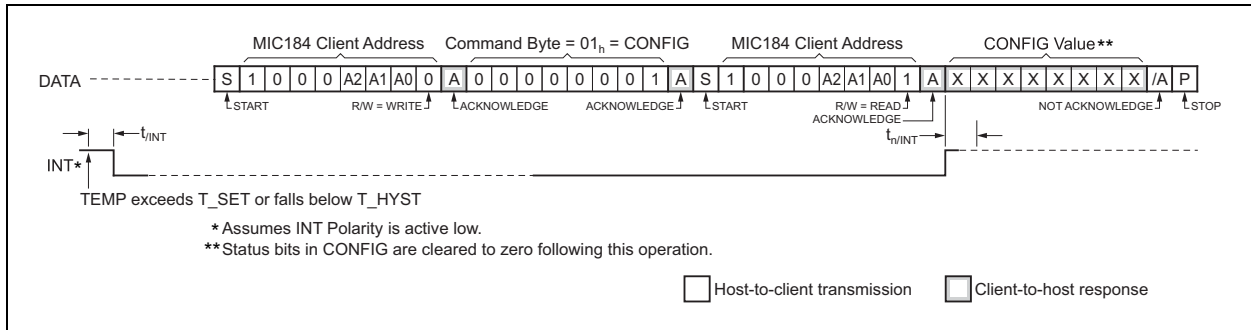

FIGURE 4-7: Responding to Interrupts.

MIC184

4.1.11 A/D CONVERTER TIMING

Whenever the MIC184 is not in its low power shutdown mode, the internal A/D converter (ADC) attempts to make continuous conversions unless interrupted by a bus transaction accessing the MIC184. When the MIC184 is accessed, the conversion in progress will be halted, and the partial result discarded. When the access of the MIC184 is complete the ADC will begin a new conversion cycle, with results valid t_{CONV} after that. [Figure 4-5](#) shows this behavior. t_{CONV} is twice as long for external conversions as it is for internal conversions. This allows the use of a filter capacitor on the A2/T1 input without a loss of accuracy due to the resulting longer settling times.

4.1.12 POWER-ON

When power is initially applied, the MIC184's internal registers are set to default states which make the MIC184 completely backward compatible with the LM75. At this time, the levels on the address inputs A2, A1, and A0 are read to establish the device's client address. The MIC184's power-up default state can be summarized as follows:

- Normal-mode operation (MIC184 not in shutdown)
- ZONE is set to internal (on-chip temperature sensing)
- INT function is set to comparator mode
- INT output is set to active-low operation
- Fault_Queue depth = 1
- Interrupts are enabled (IM = 0)
- T_SET = +80°C; T_HYST = +75°C

In order to accommodate the use of A2/T1 as a dual-purpose input, there is a weak pull-down on A2/T1 that will attempt to sink $\approx 25 \mu\text{A}$ from the pin to ground for t_{POR} following power-up of the MIC184. This allows the MIC184 to pull A2/T1 to a low state when a diode junction is connected from that pin to ground, and latch a zero as the A2 address value. If A2 is not to be used as a diode connection, it should be connected to V_{DD} or ground. Note that a fault in the external temperature sensor (if used) may not be reported until one or more conversion cycles have been completed following power-on. See [Diode Faults](#).

4.1.13 SHUTDOWN MODE

Setting the SHDN bit in the configuration register halts the otherwise continuous conversions by the A/D converter. The MIC184's power consumption drops to 1 μA typical in shutdown mode. All registers may be read from, or written to, while in shutdown mode. Serial bus activity will slightly increase the MIC184's power consumption.

Entering shutdown mode will not affect the state of INT when the device is in comparator mode (MODE = 0). However, if the device is shut down while in interrupt

mode, the INT pin will be de-asserted and the internal latch (STS) holding the interrupt status will be cleared. Therefore, no interrupts will be generated while the MIC184 is in shutdown mode, and the interrupt status will not be retained. It is important to note, however, that the cause of the last temperature event will be retained in the MIC184. This is described further in [Comparator and Interrupt Modes](#). The diode fault detection mechanism requires one or more A/D conversion cycles to detect external sensor faults. (See [Diode Faults](#)) No diode faults will be detected while the device is in shutdown mode.

4.1.14 COMPARATOR AND INTERRUPT MODES

Depending on the setting of the MODE bit in the configuration register, the INT output will behave either as an interrupt request signal or a thermostatic control signal. Thermostatic operation is known as comparator mode. The INT output is asserted whenever the measured temperature, as reported in the TEMP register, exceeds the threshold programmed in the T_SET register for the number of conversions specified by Fault_Queue (described below). In comparator mode, INT will remain asserted unless and until the measured temperature falls below the value in the T_HYST register for Fault_Queue conversions. No action on the part of the host is required for operation in comparator mode. Note that entering shutdown mode will not affect the state of INT when the device is in comparator mode.

In interrupt mode, once a temperature event has caused STS to be set, and the INT output to be asserted, they will not be automatically de-asserted when the measured temperature falls below T_HYST. They can only be de-asserted by reading any of the MIC184's internal registers or by putting the device into SHUTDOWN mode. If the most recent temperature event was an overtemperature condition, STS will not be set again, and INT cannot be reasserted, until the device has detected that $\text{TEMP} < \text{T_HYST}$. Similarly, if the most recent temperature event was an undertemperature condition, STS will in be set again, and INT cannot be reasserted, until the device has detected that $\text{TEMP} > \text{T_SET}$. This keeps the internal logic of the MIC184 backward compatible with that of the LM75 and similar devices. There is a software override for this: while the MIC184 is operating in interrupt mode, the part can be unconditionally set to monitor for an overtemperature condition, regardless of what caused the last temperature event. This is done by clearing the MODE bit, and then immediately resetting it to 1. Following this sequence the next temperature event detected will be an overtemperature condition, regardless of whether the last temperature event was the result of an overtemperature or undertemperature condition.

In both modes, the MIC184 will be responsive to overtemperature events upon power up.

4.1.15 FAULT_QUEUE

A Fault_Queue (programmable digital filter) is provided in the MIC184 to prevent false tripping due to thermal or electrical noise. Two bits, CONFIG[4:3], set the depth of Fault_Queue. Fault_Queue then determines the number of consecutive temperature events ($TEMP > T_SET$ or $TEMP < T_HYST$) which must occur in order for the condition to be considered valid. As an example, assume the MIC184 is in comparator mode, and CONFIG[4:3] is programmed with 10_b . Then the measured temperature would have to exceed T_SET for four consecutive A/D conversions before INT would be asserted or the status bit set. Similarly, $TEMP$ would have to be less than T_HYST for four consecutive conversions before INT would be reset. Like any filter, the Fault_Queue function also has the effect of delaying the detection of temperature events. In this example, it would take four times the t_{CONV} to detect a temperature event. The depth of Fault_Queue vs. D[4:3] of the configuration register is shown in [Table 4-4](#).

TABLE 4-4: FAULT_QUEUE DEPTH SETTINGS

CONFIG [4:3]	Fault_Queue Depth
00	1 conversion (default)
01	2 conversions
10	4 conversions
11	6 conversions

4.1.16 HANDLING INTERRUPTS

The MIC184 may be either polled by the host, or request the host's attention via the INT pin. In the case of polled operation, the host periodically reads the contents of CONFIG to check the state of the status bit. The act of reading CONFIG clears the status bit, STS. If more than one event that sets the status bit occurs before the host polls the MIC184, only the fact that at least one such event has occurred will be apparent to the host.

If $TEMP < T_HYST$ or $TEMP > T_SET$ for Fault_Queue conversions, the status bit STS will be set in the CONFIG register. This action cannot be masked. However, a temperature event will only generate an interrupt signal on INT if interrupts from the MIC184 are enabled ($IM = 0$ and $MODE = 1$ in the configuration register). Reading any register following an interrupt will cause INT to be de-asserted, and will clear STS. The host should read the contents of the configuration register after receiving an interrupt to confirm that the MIC184 was the source of the interrupt. This is shown in [Figure 4-7](#). As noted above, putting the device into shutdown mode will also de-assert INT and clear STS. Therefore, this usually should not be done before

completing the appropriate interrupt service routine(s). Since temperature-to-digital conversions continue while INT is asserted, it is possible that temperature could change between the MIC184's assertion of its INT output and the host's response to the interrupt. It is good practice when servicing interrupts for the host to read the current temperature to confirm that the condition that caused the interrupt still exists.

4.1.17 INTERRUPT POLARITY SELECTION

The INT output can be programmed to behave as an active-low signal or an active-high signal. The default is active-low. INT polarity is selected by programming the appropriate value into the polarity bit (POL) in the CONFIG register. Clearing POL selects active-low interrupts; setting POL selects active-high interrupts. INT is an open-drain digital output and may be wire-ORed with other open-drain logic signals. Most applications will require a pull-up resistor on this pin.

Whether the CONFIG register's POL bit is set to provide a current-sinking (low) or high-Z (high) state at the INT pin when STS is high, writing a one to IM will put the INT pin into a high-Z state. This meets the requirement of an active-low interrupt for the SMBus, while making IM available as an INT-forcing bit for those applications which employ an active-high INT output (for example, software fan-control routines).

4.1.18 LM75 COMPATIBILITY

The MIC184 can be used interchangeably with the LM75 in existing applications. The MIC184 offers several advantages over the LM75:

- Ability to monitor a second, remote temperature
- Interrupt masking capability
- Status bit for software polling routines
- Lower quiescent current
- Supports single-byte reads from 16-bit registers
- No "inadvertent 8-bit read" bus lock-up issues

The three MSB's of the configuration register (which power up as zeros) are used to access the MIC184's additional functions. These are reserved bits according to the LM75 specification and, for the LM75, must always be written as zeros. The MSB of the MIC184's status register is a status flag that does not exist in the LM75. This bit will be set to one whenever an overtemperature event occurs. This bit would never be set by an LM75. Software should not depend on this bit being zero when using the MIC184 as an LM75 upgrade. If at power-up the measured temperature is higher than T_SET , the status bit will be set following the first conversion by the A/D. See ["Applications Information"](#) for a method by which host software can use this fact to differentiate between an MIC184 and an LM75.

MIC184

5.0 REGISTER SET AND PROGRAMMER'S MODEL

TABLE 5-1: INTERNAL REGISTER SET

Name	Description	Command	Operation	Power-Up Default	
TEMP	Measured Temperature	00h	9-bit read	0 0000 0000b	0°C (Note 1)
CONFIG	Configuration Register	01h	8-bit	0000 0000b	(Note 2)
T_HYST	Hysteresis	02h	9-bit	0 1001 0110b	+75°C
T_SET	Temperature Setpoint	03h	9-bit	0 1010 0000b	+80°C

Note 1: TEMP will contain measured temperature data for the selected zone after the completion of one conversion.

2: After the first Fault_Queue conversions are complete, the status bit will be set if TEMP < T_HYST or TEMP > T_SET.

TABLE 5-2: DETAILED REGISTER DESCRIPTIONS

CONFIG (8-Bit Read/Write)							
D[7]	D[6]	D[5]	D[4]	D[3]	D[2]	D[1]	D[0]
Read Only	Read/Write	Read/Write	Read/Write	Read/Write	Read/Write	Read/Write	Read/Write
Interrupt Status (STS)	Interrupt Mask (IM) (Note 1)	Temp Select (ZONE)	Fault Queue Depth (F_Q)		Int Polarity (POL)	COMP/INT Mode (MODE)	Shutdown (SHDN)
Bits	Function				Operation		
STS	Interrupt status (read only)				1 = interrupt occurred, 0 = none		
IM	Interrupt mask				0 = enabled, 1 = disabled		
ZONE	Internal/remote temperature selection				1 = remote, 0 = internal		
F_Q	Fault_Queue depth				00 = 1 conversion, 01 = 2 conversions, 10 = 4 conversions, 11 = 6 conversions		
POL	INT output polarity selection				1 = active-high, 0 = active-low		
MODE	Comparator/interrupt mode selection for INT pin				1 = interrupt mode, 0 = comparator mode		
SHDN	Normal/shutdown Operating mode selection				1 = shutdown, 0 = normal		
Note 1: Setting IM forces the open-drain INT output into its high-Z state. See Interrupt Polarity Selection .							

Power-Up Default Value: 0000 0000b = 00h.

- Not in shutdown mode
- Comparator mode
- INT = active low
- Fault_Queue depth = 1
- Local temperature zone
- Interrupts enabled.

CONFIG Command Byte Address: 0000 0001b = 01h

Note that after the first Fault_Queue conversions are completed, the status bit will be set if TEMP < T_HYST or TEMP > T_SET.

TABLE 5-3: TEMPERATURE RESULT REGISTER

TEMP (9-Bit Read Only)																
D[15]	D[14]	D[13]	D[12]	D[11]	D[10]	D[9]	D[8]	D[7]	D[6]	D[5]	D[4]	D[3]	D[2]	D[1]	D[0]	
MSB	bit 7	bit 6	bit 5	bit 4	bit 3	bit 2	bit 1	LSB	X	X	X	X	X	X	X	
Temperature Data from ADC																
Bits	Function								Operation							
D[15: 7]	Measured temperature data for selected zone								Read only (Note)							

Note 1: The value in TEMP is 9 logical bits in width, but due to the conventions of I²C/SMBus, it is represented by 16 serial bits. System software should ignore undefined bits D[6:0]. See [Serial Port Operation](#) and [Temperature Data Format](#) for more details.

Power-Up Default Value: 0 0000 0000b = 0°C. TEMP will contain measured temperature data for the selected zone after the completion of one conversion. TEMP Command Byte Address: 0000 0000b = 00h.

TABLE 5-4: HYSTERESIS REGISTER

T_HYST (9-Bit Read/Write)																
D[15]	D[14]	D[13]	D[12]	D[11]	D[10]	D[9]	D[8]	D[7]	D[6]	D[5]	D[4]	D[3]	D[2]	D[1]	D[0]	
MSB	BIT 7	BIT6	BIT5	BIT4	BIT3	BIT2	BIT1	LSB	X	X	X	X	X	X	X	
Temperature Hysteresis Setting																
Bits	Function								Operation							
D[15:7]	Temperature Hysteresis Setting								Read/Write (Note 1)							

Note 1: The value in T_HYST is 9 logical bits in width, but due to the conventions of I²C/SMBus, it is represented by 16 serial bits. System software should ignore undefined bits D[6:0] during register reads. Bits [6:0] should be set to zero during register writes. See [Serial Port Operation](#) and [Temperature Data Format](#) for more details.

T_HYST Power-Up Default Value: 0 1001 0110b (+75°C) T_HYST Command Byte Address: 0000 0010b = 02h

TABLE 5-5: TEMPERATURE SETPOINT REGISTER

T_SET (9-Bit Read/Write)																
D[15]	D[14]	D[13]	D[12]	D[11]	D[10]	D[9]	D[8]	D[7]	D[6]	D[5]	D[4]	D[3]	D[2]	D[1]	D[0]	
MSB	BIT 7	BIT6	BIT5	BIT4	BIT3	BIT2	BIT1	LSB	X	X	X	X	X	X	X	
Overtemperature Setpoint																
BITS	FUNCTION								OPERATION							
D[15:7]	Overtemperature Comparator Setpoint								Read/Write (Note 1)							

Note 1: The value in T_SET is 9 logical bits in width, but due to the conventions of I²C/SMBus, it is represented by 16 serial bits. System software should ignore undefined bits D[6:0] during register reads. Bits [6:0] should be set to zero during register writes. See [Serial Port Operation](#) and [Temperature Data Format](#) for more details.

T_SET Power-Up Default Value: 0 1010 0000b (+80°C) T_SET Command Byte Address: 0000 0011b = 03h

6.0 APPLICATIONS INFORMATION

6.1 Switching Zones

The recommended procedure for switching between the internal and external zones is as follows:

1. Disable interrupts (if used) by setting the IM bit in CONFIG.
2. Read the CONFIG register to:
 - a) Verify no masked interrupt was pending ($D[7] = 0$)
 - b) Clear STS prior to switching zones
 - c) Hold the settings of CONFIG register for the current zone
3. Write the appropriate values to T_SET and T_HYST for the new zone.
4. Write to CONFIG as follows:
 - a) To toggle the ZONE bit (1 = remote, 0 = internal)
 - b) If interrupts are being used, step 4 should also clear MODE
5. If interrupts are being used, MODE must then be set to 1 and IM reset to 0

At the conclusion of the serial bus transaction for step 4, the A/D converter will begin a conversion cycle using the new zone setting. The next conversion cycle completed after the serial bus transaction for step 5 will result in the state of the INT output being updated (if enabled) for the new zone. Generally the MIC184's A/D converter operates continuously, but it will be halted and reset each time the part recognizes its client address on the serial bus. Interrupted conversions will remain halted until the end of the host's communication with the MIC184. After the completion of step 5 and a delay of $t_{CONV} \times \text{Fault_Queue}$, STS and INT will contain the results for the new zone. The above routine is extremely unlikely to miss a temperature event, as even one A/D conversion is typically much slower than the I²C/SMBus transactions that control the MIC184. See [Figure 4-6](#).

Step 2(c) is recommended because the MIC184 has only one CONFIG register, corresponding to the active zone. In order to preserve data integrity for both zones, 2(c) allows the host to create a virtual CONFIG register for the inactive zone by dedicating one byte of memory to that purpose. Additional virtual registers may be created as needed by inserting additional reads as steps 2(d), 2(e), etc. These could for example correspond to the values in T_SET and T_HYST immediately prior to switching zones. Steps 4(b) and 5 ensure that the MIC184 will enter the new zone searching for an overtemperature event.

6.2 Identifying an MIC184 by Software Test

The MIC184 and the LM75 each have an eight-bit CONFIG register. In LM75-type parts, no more than seven of the eight bits of this register are used, and at least one bit (the MSB) will always return a zero. The MIC184 uses all eight bits of the CONFIG register: the MSB is the part's status bit (STS). A simple test by which the host can determine whether a system has an MIC184 installed, or is using a legacy LM75-type device, is to create a situation which will set the MSB in the MIC184's CONFIG register and then determine if the MSB is in fact set. Two examples of how this can be done are outlined below. The first is interrupt-driven, the second uses software polling. Note that both procedures generate one or more spurious interrupts. The code for these tests should therefore temporarily disable any affected interrupt routines.

{START Interrupt-Driven Test and Initialization Routine}

1. Disable the host's overtemperature and under-temperature interrupt handling routine. Redirect interrupts from the part under test to a handler for the interrupt that will be generated in steps (4) and (7) of this routine.
2. Write 0000 0010b (02h) to the CONFIG register. (The assumption is made that the host is an I²C or SMBus part, and therefore responds to an active-low interrupt request.)
3. Write 1100 1000 1000 0000b = C880h to T_SET and T_HYST. This corresponds to -55.5°C .
4. When the part has finished its first A/D conversion, INT will be asserted.
5. Read out the contents of the CONFIG register:
 - a) If the part is an MIC184, the MSB will be set to one (CONFIG = 1000 0010b = 82h).
 - b) If the part is a conventional LM75-type part, the MSB will be zero (CONFIG = 0000 0010b = 02h).
6. Write 0111 1111 1000 0000b = 7F80h to T_SET and T_HYST. This corresponds to $+127.5^{\circ}\text{C}$.
7. When the part has finished its next A/D conversion, INT will be asserted a second time.
8. Read CONFIG again, to clear the interrupt request from step (7). This will also clear STS, if the part under test is an MIC184.
9. Based on the results of the test in step (4), do the following within 50 ms total:
 - a) Set the CONFIG register as required.
 - b) Load T_HYST with its operational value.
 - c) Load T_SET with its operational value.
 - d) Set the host's interrupt handling routine back to overtemperature and undertemperature mode.

{END}

{START Polling-Based Test and Initialization Routine}

1. Temporarily disable the host's interrupt input from the device under test.
2. Write 0000 0010b (02h) to the CONFIG register.
3. Write 1100 1000 1000 0000b = C880h to T_SET and T_HYST. This corresponds to -55.5°C.
4. Wait t_{conv} (160 ms max.) for the part to finish at least one A/D conversion.
5. Read the contents of the CONFIG register:
 - a) If the part is an MIC184, the MSB will be set to one (CONFIG = 82h).
 - b) If the part is a conventional LM75-type part, the MSB will be zero (CONFIG = 02h).
6. Write 0111 1111 1000 0000b = 7F80h to T_SET and T_HYST. This corresponds to +127.5°C.
7. Wait an additional t_{conv} for the part to finish a second conversion.
8. Read CONFIG again, to clear the interrupt request from step (7). This will also clear STS, if the part under test is an MIC184.
9. Based on the results of the test in step (4), do the following four steps within 50 ms total:
 - a) Set the CONFIG register as required.
 - b) Load T_HYST with its operational value.
 - c) Load T_SET with its operational value.
 - d) Re-enable the host's interrupt handling input from the part under test.

{END}

These routines force the device under test to generate an overtemperature fault (steps 3 and 4), followed by an undertemperature fault (steps 6 through 8). This sequence causes the device under test to exit the routine prepared to respond to an overtemperature condition. If being immediately prepared to detect an undertemperature condition upon exit is desired, swap steps 3 and 6 in each routine.

6.3 Remote Diode Selection

Most small-signal PNP transistors with characteristics similar to the JEDEC 2N3906 will perform well as remote temperature sensors. [Table 6-1](#) lists several examples of such parts. These parts have been tested and marked with a bullet for use with the MIC184.

TABLE 6-1: TRANSISTORS SUITABLE FOR REMOTE TEMPERATURE SENSING USE

Vendor	Part Number	Package	Tested
Fairchild	MMBT3906	SOT-23	Yes
On Semiconductor	MMBT3906L	SOT-23	Yes
Philips	PMBT390	SOT-23	Yes
Rohm Semiconductor	SST3906	SOT-23	—
Samsung	KST3906-TF	SOT-23	—
Zetex	FMMT3906	SOT-23	—

6.4 Minimizing Errors

6.4.1 SELF-HEATING

One concern when using a part with the temperature accuracy and resolution of the MIC184 is to avoid errors induced by self-heating ($V_{DD} \times I_{DD}$). In order to understand what level of error this might represent, and how to reduce that error, the dissipation in the MIC184 must be calculated, and its effects examined as a temperature error.

In most applications, the INT output will be low for at most a few milliseconds before the host sets it back to the high state, making its duty cycle low enough that its contribution to self-heating of the MIC184 is negligible. Similarly, the DATA pin will in all likelihood have a duty cycle of substantially below 25% in the low state. These considerations, combined with more typical device and application parameters, allow the following calculation of typical device self-heating in interrupt-mode:

EQUATION 6-1:

$$P_D = (I_{DD(typ)}3.3V + 25\%I_{OL(data)}0.3V + 1\%I_{OL(int)}0.3V)$$

EQUATION 6-2:

$$P_D = (0.3mA \times 3.3V + 25\% \times 1.5mA \times 0.3V + 1\% \times 1.5mA \times 0.3V)$$

EQUATION 6-3:

$$\Delta T_J = 1.11mW \times 206^\circ C/W$$

Note: ΔT_J relative to T_A is 0.23°C.

If the part is to be used in comparator mode, calculations similar to those shown above (accounting for the expected value and duty cycle of $I_{OL(int)}$) will give a good estimate of the device's self-heating error.

In any application, the best test is to verify performance against calculation in the final application environment. This is especially true when dealing with systems for which some of the thermal data, (for example, PC board thermal conductivity and/or ambient temperature), may be poorly defined or unavailable except by empirical means.

6.5 Series Resistance

The operation of the MIC184 depends upon sensing the ΔV_{CB-E} of a diode-connected PNP transistor ("diode") at two different current levels. For remote temperature measurements, this is done using an external diode connected between A2/T1 and ground.

Because this technique relies upon measuring the relatively small voltage difference resulting from two levels of current through the external diode, any resistance in series with the external diode will cause an error in the temperature reading from the MIC184. A good rule of thumb is this: for each ohm in series with the external transistor, there will be a 0.9°C error in the MIC184's temperature measurement. It is not difficult to keep the series resistance well below an ohm (typically 0.1Ω), so in most systems this will not be an issue.

6.6 Filter Capacitor Selection

When using a remote diode for temperature sensing, it is sometimes desirable to use a filter capacitor between the A2/T1 and GND pins of the MIC184. The use of this capacitor is recommended in environments with a significant high frequency noise (such as digital switching noise), or if long wires are used to connect to the remote diode. The maximum recommended total capacitance from the A2/T1 pin to GND is 2700 pF. This usually suggests the use of a 2200 pF NP0 or COG ceramic capacitor with a 10% tolerance.

If the remote diode is to be at a distance of more than 6" ~ 12" from the MIC184, using a shielded cable (solid foil shield microphone cable is a good choice) for the connections to the diode can significantly help reduce noise pickup. Remember to subtract the cable's conductor-to-shield capacitance from the 2700 pF maximum total capacitance.

6.7 Layout Considerations

Local Mode Only Applications

If the MIC184 is not going to be used with an external diode, the best layout is one that keeps it thermally coupled to the subsystem(s) whose temperature it must monitor, while avoiding any strong sources of EMI, RFI, or electrostatically coupled noise. Two of the most common examples of such sources are switching power supply transformers and CRTs.

Remote Mode Application

1. If the remote sensing capability of the MIC184 will be used in an application, place the MIC184 as close to the remote diode as possible, while taking care to avoid severe noise sources (high frequency power transformers, CRTs, memory and data buses, and the like).
2. Since any conductance from the various voltages on the PC board and the A2/T1 pin can induce serious errors, it is good practice to guard the remote diode's emitter trace with a pair of ground traces. These ground traces should be returned to the MIC184's own ground pin. They should not be grounded at any other part of their run. However, it is highly desirable to use these guard traces to carry the diode's own ground return back to the ground pin of the MIC184, thereby providing a Kelvin connection for the base of the diode. See [Figure 6-1](#).
3. When using the MIC184 to sense the temperature of a processor or other device which has an integral on-board "diode" (e.g., Intel's Pentium® III), connect the emitter and base of the remote sensor to the MIC184 using the guard traces and Kelvin return shown in [Figure 6-1](#). The collector of the remote "diode" is inaccessible to the user on these types of chips. To allow for this, the MIC184 has superb rejection of noise appearing from collector to GND, as long as the base to ground connection is relatively quiet.
4. Due to the small currents involved in the measurement of the remote diode's ΔV_{BE} , it is important to adequately clean the PC board after soldering. This is most likely to show up as an issue in some situations where water-soluble soldering fluxes are used.
5. In general, wider traces for the ground and A2/T1 pins will help reduce susceptibility to radiated noise (wider traces are less inductive). Use trace widths and spacing of 10 mm wherever possible. Wherever possible, place a ground plane under the MIC184, and under the connections from the MIC184 to the remote diode. This will help guard against stray noise pickup.
6. Always place a good quality V_{DD} bypass capacitor directly adjacent to, or underneath, the MIC184. This part should be a 0.1 μF ceramic capacitor. Surface-mount parts provide the best bypassing because of their low inductance.
7. When the MIC184 is being powered from particularly noisy power supplies, or from supplies which may have sudden high-amplitude spikes appearing on them, it can be helpful to add additional power supply filtering. This should be implemented as a 100Ω resistor in series with the part's V_{DD} pin, and a 4.7 μF, 6.3V electrolytic capacitor from V_{DD} to GND. See [Figure 6-2](#).

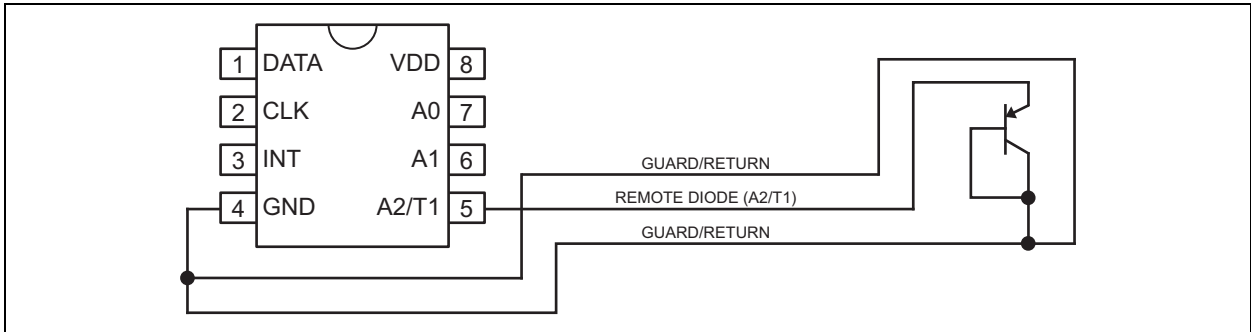

FIGURE 6-1: Guard Traces/Kelvin Ground Returns.

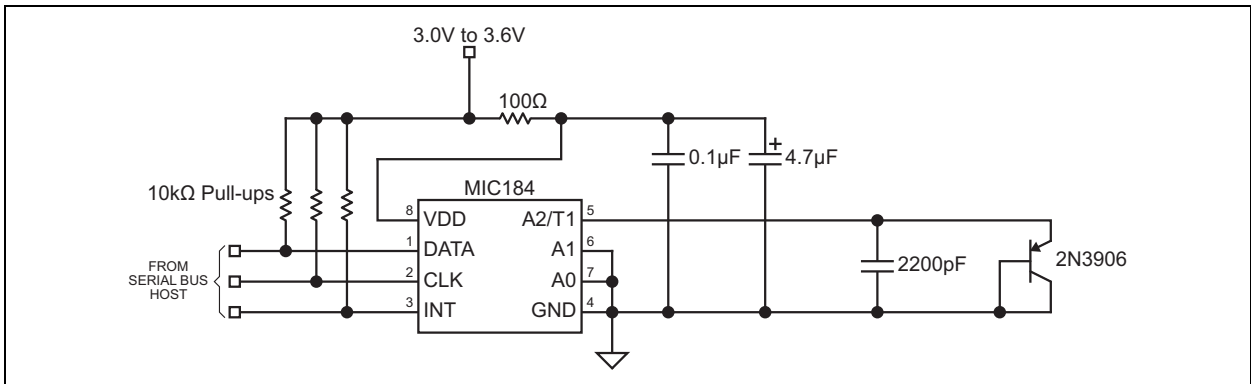
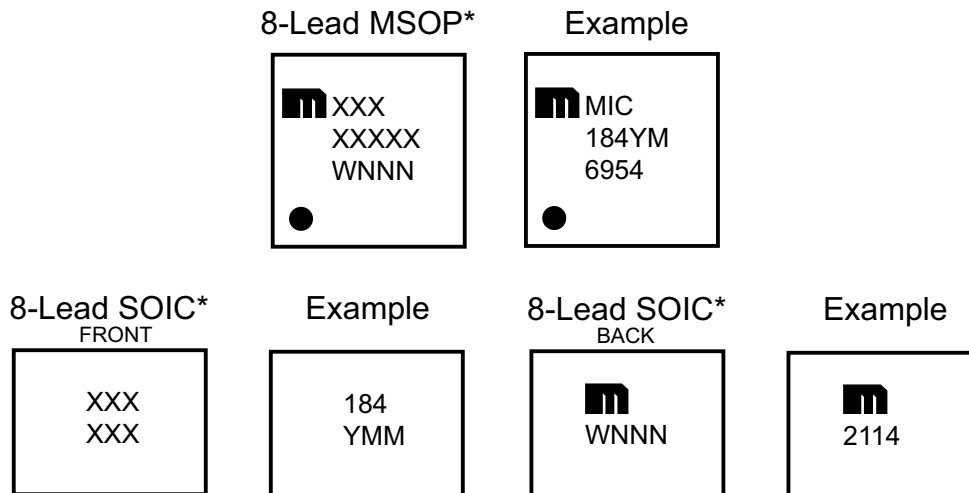

FIGURE 6-2: V_{DD} Decoupling for Very Noisy Supplies.

MIC184

7.0 PACKAGING INFORMATION

7.1 Package Marking Information



Legend:	XX...X	Product code or customer-specific information
	Y	Year code (last digit of calendar year)
	YY	Year code (last 2 digits of calendar year)
	WW	Week code (week of January 1 is week '01')
	NNN	Alphanumeric traceability code
	(e3)	Pb-free JEDEC® designator for Matte Tin (Sn)
	*	This package is Pb-free. The Pb-free JEDEC designator (e3) can be found on the outer packaging for this package.
	•, ▲, ▼	Pin one index is identified by a dot, delta up, or delta down (triangle mark).
Note:	In the event the full Microchip part number cannot be marked on one line, it will be carried over to the next line, thus limiting the number of available characters for customer-specific information. Package may or may not include the corporate logo.	
	Underbar (¯) and/or Overbar (¯) symbol may not be to scale.	

8-Lead MSOP Package Outline and Recommended Land Pattern

TITLE

8 LEAD MSOP PACKAGE OUTLINE & RECOMMENDED LAND PATTERN

DRAWING #	MSOP-8LD-PL-1	UNIT	INCH [MM]
-----------	---------------	------	-----------

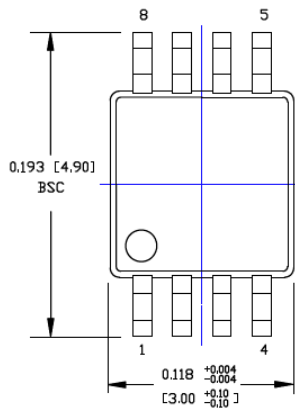

TOP VIEW

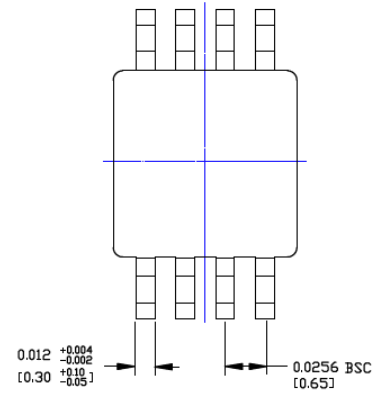

BOTTOM VIEW

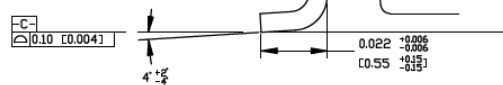

DETAIL A

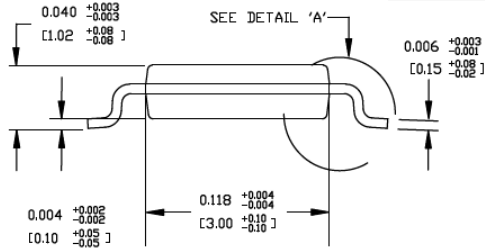

SIDE VIEW

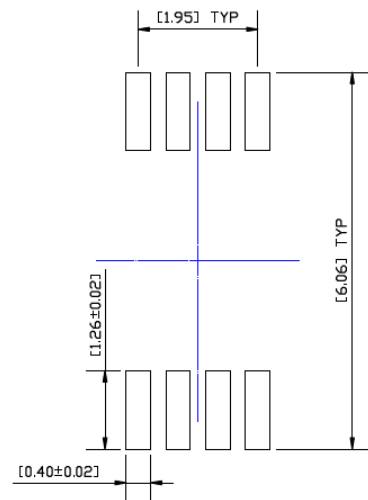

RECOMMENDED LAND PATTERN

NOTES:

1. DIMENSIONS ARE IN INCHES [MM].
2. CONTROLLING DIMENSION: MM
3. DIMENSION DOES NOT INCLUDE MOLD FLASH OR PROTRUSIONS, EITHER OF WHICH SHALL NOT EXCEED 0.008 [0.20] PER SIDE.

Note: For the most current package drawings, please see the Microchip Packaging Specification located at <http://www.microchip.com/packaging>.

MIC184

8-Lead SOIC Package Outline and Recommended Land Pattern

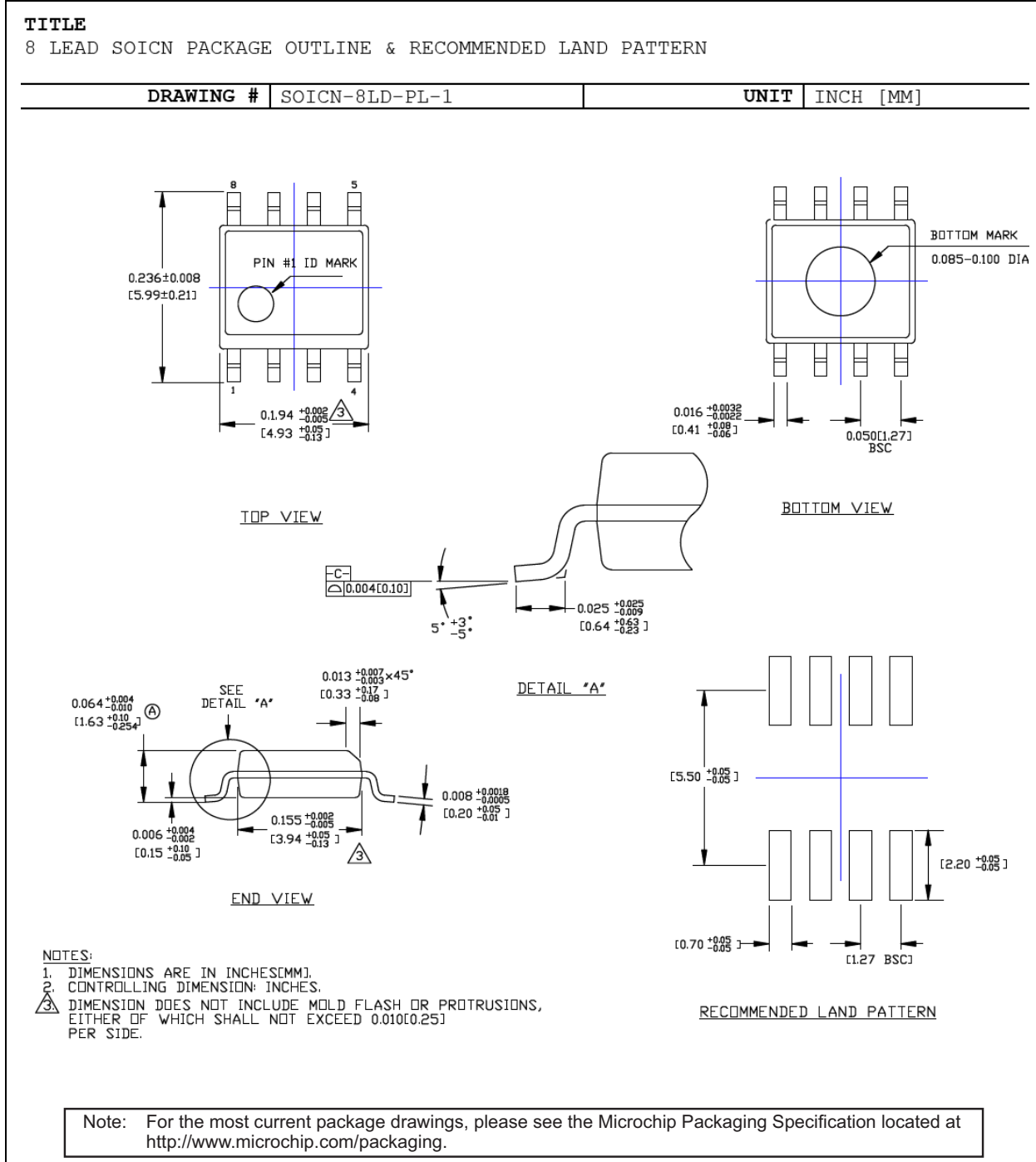

APPENDIX A: REVISION HISTORY

Revision A (November 2020)

- Converted Micrel data sheet MIC184 to Microchip data sheet DS20006457A.
- Minor grammatical corrections throughout.

MIC184

NOTES:

PRODUCT IDENTIFICATION SYSTEM

To order or obtain information, e.g., on pricing or delivery, contact your local Microchip representative or sales office.

<u>PART NO.</u>	<u>X</u>	<u>XX</u>	<u>-XX</u>	Examples:
Device	Temperature Range	Package	Media Type	
Device:	MIC184:	Local/Remote Thermal Supervisor		a) MIC184YMM-TR: MIC184, -55°C to +125°C Temperature Range, 8-Lead MSOP, 2500/Reel
Temperature Range:	Y =	-55°C to +125°C		b) MIC184YMM: MIC184, -55°C to +125°C Temperature Range, 8-Lead MSOP, 100/Tube
Package:	M =	8-Lead SOIC		c) MIC184YM-TR: MIC184, -55°C to +125°C Temperature Range, 8-Lead SOIC, 2500/Reel
	MM =	8-Lead MSOP		d) MIC184YM: MIC184, -55°C to +125°C Temperature Range, 8-Lead SOIC, 95/Tube
Media Type:	<blank>=	95/Tube (SOIC Option)		Note 1: Tape and Reel identifier only appears in the catalog part number description. This identifier is used for ordering purposes and is not printed on the device package. Check with your Microchip Sales Office for package availability with the Tape and Reel option.
	<blank>=	100/Tube (MSOP Option)		
	TR =	2500/Reel		

MIC184

NOTES:

Note the following details of the code protection feature on Microchip devices:

- Microchip products meet the specifications contained in their particular Microchip Data Sheet.
- Microchip believes that its family of products is secure when used in the intended manner and under normal conditions.
- There are dishonest and possibly illegal methods being used in attempts to breach the code protection features of the Microchip devices. We believe that these methods require using the Microchip products in a manner outside the operating specifications contained in Microchip's Data Sheets. Attempts to breach these code protection features, most likely, cannot be accomplished without violating Microchip's intellectual property rights.
- Microchip is willing to work with any customer who is concerned about the integrity of its code.
- Neither Microchip nor any other semiconductor manufacturer can guarantee the security of its code. Code protection does not mean that we are guaranteeing the product is "unbreakable." Code protection is constantly evolving. We at Microchip are committed to continuously improving the code protection features of our products. Attempts to break Microchip's code protection feature may be a violation of the Digital Millennium Copyright Act. If such acts allow unauthorized access to your software or other copyrighted work, you may have a right to sue for relief under that Act.

Information contained in this publication is provided for the sole purpose of designing with and using Microchip products. Information regarding device applications and the like is provided only for your convenience and may be superseded by updates. It is your responsibility to ensure that your application meets with your specifications.

THIS INFORMATION IS PROVIDED BY MICROCHIP "AS IS". MICROCHIP MAKES NO REPRESENTATIONS OR WARRANTIES OF ANY KIND WHETHER EXPRESS OR IMPLIED, WRITTEN OR ORAL, STATUTORY OR OTHERWISE, RELATED TO THE INFORMATION INCLUDING BUT NOT LIMITED TO ANY IMPLIED WARRANTIES OF NON-INFRINGEMENT, MERCHANTABILITY, AND FITNESS FOR A PARTICULAR PURPOSE OR WARRANTIES RELATED TO ITS CONDITION, QUALITY, OR PERFORMANCE.

IN NO EVENT WILL MICROCHIP BE LIABLE FOR ANY INDIRECT, SPECIAL, PUNITIVE, INCIDENTAL OR CONSEQUENTIAL LOSS, DAMAGE, COST OR EXPENSE OF ANY KIND WHATSOEVER RELATED TO THE INFORMATION OR ITS USE, HOWEVER CAUSED, EVEN IF MICROCHIP HAS BEEN ADVISED OF THE POSSIBILITY OR THE DAMAGES ARE FORESEEABLE. TO THE FULLEST EXTENT ALLOWED BY LAW, MICROCHIP'S TOTAL LIABILITY ON ALL CLAIMS IN ANY WAY RELATED TO THE INFORMATION OR ITS USE WILL NOT EXCEED THE AMOUNT OF FEES, IF ANY, THAT YOU HAVE PAID DIRECTLY TO MICROCHIP FOR THE INFORMATION. Use of Microchip devices in life support and/or safety applications is entirely at the buyer's risk, and the buyer agrees to defend, indemnify and hold harmless Microchip from any and all damages, claims, suits, or expenses resulting from such use. No licenses are conveyed, implicitly or otherwise, under any Microchip intellectual property rights unless otherwise stated.

Trademarks

The Microchip name and logo, the Microchip logo, Adaptec, AnyRate, AVR, AVR logo, AVR Freaks, BesTime, BitCloud, chipKIT, chipKIT logo, CryptoMemory, CryptoRF, dsPIC, FlashFlex, flexPWR, HELDO, IGL00, JukeBlox, KeeLoq, Kleer, LANCheck, LinkMD, maXStylus, maXTouch, MediaLB, megaAVR, Microsemi, Microsemi logo, MOST, MOST logo, MPLAB, OptoLyzer, PackeTime, PIC, picoPower, PICSTART, PIC32 logo, PolarFire, Prochip Designer, QTouch, SAM-BA, SenGenuity, SpyNIC, SST, SST Logo, SuperFlash, Symmetricom, SyncServer, Tachyon, TimeSource, tinyAVR, UNI/O, Vectron, and XMEGA are registered trademarks of Microchip Technology Incorporated in the U.S.A. and other countries.

AgileSwitch, APT, ClockWorks, The Embedded Control Solutions Company, EtherSynch, FlashTec, Hyper Speed Control, HyperLight Load, IntelliMOS, Libero, motorBench, mTouch, Powermite 3, Precision Edge, ProASIC, ProASIC Plus, ProASIC Plus logo, Quiet-Wire, SmartFusion, SyncWorld, Temux, TimeCesium, TimeHub, TimePictra, TimeProvider, WinPath, and ZL are registered trademarks of Microchip Technology Incorporated in the U.S.A.

Adjacent Key Suppression, AKS, Analog-for-the-Digital Age, Any Capacitor, AnyIn, AnyOut, Augmented Switching, BlueSky, BodyCom, CodeGuard, CryptoAuthentication, CryptoAutomotive, CryptoCompanion, CryptoController, dsPICDEM, dsPICDEM.net, Dynamic Average Matching, DAM, ECAN, Espresso T1S, EtherGREEN, IdealBridge, In-Circuit Serial Programming, ICSP, INICnet, Intelligent Paralleling, Inter-Chip Connectivity, JitterBlocker, maxCrypto, maxView, memBrain, Mindi, MiWi, MPASM, MPF, MPLAB Certified logo, MPLIB, MPLINK, MultiTRAK, NetDetach, Omniscient Code Generation, PICDEM, PICDEM.net, PICkit, PICtail, PowerSmart, PureSilicon, QMatrix, REAL ICE, Ripple Blocker, RTAX, RTG4, SAM-ICE, Serial Quad I/O, simpleMAP, SimpliPHY, SmartBuffer, SMART-I.S., storClad, SQI, SuperSwitcher, SuperSwitcher II, Switchtec, SynchroPHY, Total Endurance, TSHARC, USBCheck, VariSense, VectorBlox, VeriPHY, ViewSpan, WiperLock, XpressConnect, and ZENA are trademarks of Microchip Technology Incorporated in the U.S.A. and other countries.

SQTP is a service mark of Microchip Technology Incorporated in the U.S.A.

The Adaptec logo, Frequency on Demand, Silicon Storage Technology, and Symmcom are registered trademarks of Microchip Technology Inc. in other countries.

GestIC is a registered trademark of Microchip Technology Germany II GmbH & Co. KG, a subsidiary of Microchip Technology Inc., in other countries.

All other trademarks mentioned herein are property of their respective companies.

© 2020, Microchip Technology Incorporated, All Rights Reserved.

ISBN: 978-1-5224-7145-5

For information regarding Microchip's Quality Management Systems, please visit www.microchip.com/quality.



MICROCHIP

Worldwide Sales and Service

AMERICAS

Corporate Office
2355 West Chandler Blvd.
Chandler, AZ 85224-6199
Tel: 480-792-7200
Fax: 480-792-7277
Technical Support:
<http://www.microchip.com/support>
Web Address:
www.microchip.com

Atlanta

Duluth, GA
Tel: 678-957-9614
Fax: 678-957-1455

Austin, TX

Tel: 512-257-3370

Boston

Westborough, MA
Tel: 774-760-0087
Fax: 774-760-0088

Chicago

Itasca, IL
Tel: 630-285-0071
Fax: 630-285-0075

Dallas

Addison, TX
Tel: 972-818-7423
Fax: 972-818-2924

Detroit

Novi, MI
Tel: 248-848-4000

Houston, TX

Tel: 281-894-5983

Indianapolis

Noblesville, IN
Tel: 317-773-8323
Fax: 317-773-5453
Tel: 317-536-2380

Los Angeles

Mission Viejo, CA
Tel: 949-462-9523
Fax: 949-462-9608
Tel: 951-273-7800

Raleigh, NC

Tel: 919-844-7510

New York, NY

Tel: 631-435-6000

San Jose, CA

Tel: 408-735-9110
Tel: 408-436-4270

Canada - Toronto

Tel: 905-695-1980
Fax: 905-695-2078

ASIA/PACIFIC

Australia - Sydney
Tel: 61-2-9868-6733

China - Beijing
Tel: 86-10-8569-7000

China - Chengdu
Tel: 86-28-8665-5511

China - Chongqing
Tel: 86-23-8980-9588

China - Dongguan
Tel: 86-769-8702-9880

China - Guangzhou
Tel: 86-20-8755-8029

China - Hangzhou
Tel: 86-571-8792-8115

China - Hong Kong SAR
Tel: 852-2943-5100

China - Nanjing
Tel: 86-25-8473-2460

China - Qingdao
Tel: 86-532-8502-7355

China - Shanghai
Tel: 86-21-3326-8000

China - Shenyang
Tel: 86-24-2334-2829

China - Shenzhen
Tel: 86-755-8864-2200

China - Suzhou
Tel: 86-186-6233-1526

China - Wuhan
Tel: 86-27-5980-5300

China - Xian
Tel: 86-29-8833-7252

China - Xiamen
Tel: 86-592-2388138

China - Zhuhai
Tel: 86-756-3210040

ASIA/PACIFIC

India - Bangalore
Tel: 91-80-3090-4444

India - New Delhi
Tel: 91-11-4160-8631

India - Pune
Tel: 91-20-4121-0141

Japan - Osaka
Tel: 81-6-6152-7160

Japan - Tokyo
Tel: 81-3-6880-3770

Korea - Daegu
Tel: 82-53-744-4301

Korea - Seoul
Tel: 82-2-554-7200

Malaysia - Kuala Lumpur
Tel: 60-3-7651-7906

Malaysia - Penang
Tel: 60-4-227-8870

Philippines - Manila
Tel: 63-2-634-9065

Singapore
Tel: 65-6334-8870

Taiwan - Hsin Chu
Tel: 886-3-577-8366

Taiwan - Kaohsiung
Tel: 886-7-213-7830

Taiwan - Taipei
Tel: 886-2-2508-8600

Thailand - Bangkok
Tel: 66-2-694-1351

Vietnam - Ho Chi Minh
Tel: 84-28-5448-2100

EUROPE

Austria - Wels
Tel: 43-7242-2244-39
Fax: 43-7242-2244-393

Denmark - Copenhagen
Tel: 45-4485-5910
Fax: 45-4485-2829

Finland - Espoo
Tel: 358-9-4520-820

France - Paris
Tel: 33-1-69-53-63-20
Fax: 33-1-69-30-90-79

Germany - Garching
Tel: 49-8931-9700

Germany - Haan
Tel: 49-2129-3766400

Germany - Heilbronn
Tel: 49-7131-72400

Germany - Karlsruhe
Tel: 49-721-625370

Germany - Munich
Tel: 49-89-627-144-0
Fax: 49-89-627-144-44

Germany - Rosenheim
Tel: 49-8031-354-560

Israel - Ra'anana
Tel: 972-9-744-7705

Italy - Milan
Tel: 39-0331-742611
Fax: 39-0331-466781

Italy - Padova
Tel: 39-049-7625286

Netherlands - Drunen
Tel: 31-416-690399
Fax: 31-416-690340

Norway - Trondheim
Tel: 47-7288-4388

Poland - Warsaw
Tel: 48-22-3325737

Romania - Bucharest
Tel: 40-21-407-87-50

Spain - Madrid
Tel: 34-91-708-08-90
Fax: 34-91-708-08-91

Sweden - Gothenberg
Tel: 46-31-704-60-40

Sweden - Stockholm
Tel: 46-8-5090-4654

UK - Wokingham
Tel: 44-118-921-5800
Fax: 44-118-921-5820