

ECS Series

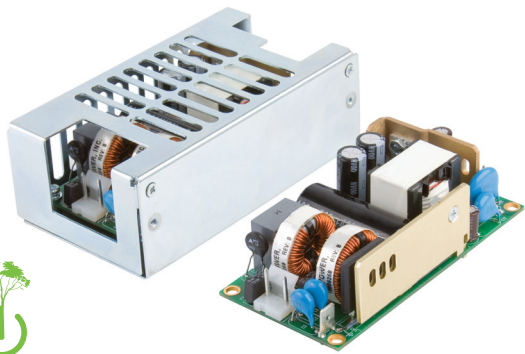

GREEN XP POWER

- IT & Medical Safety Approvals
- 65/80/100 W – Convection-cooled Ratings
- Class I & Class II Construction
- Industry Standard 2" x 4" Package
- <0.5 W No Load Input Power
- Low Leakage Current
- 3 Year Warranty

Specification

Input

Input Voltage	• 80-264 VAC derate output power <90 VAC, see derating curves
Input Frequency	• 47-63 Hz ⁽¹⁾
Input Current	• 65 W: 1.0/0.6 A typical at 115/230 VAC 100 W: 1.5/0.9 A typical at 115/230 VAC, 130 W: 1.9/1.1 A typical at 115/230 VAC full load
Inrush Current	• 40 A max at 230 VAC, cold start at 25 °C
Power Factor	• EN61000-3-2, class A
No Load Input Power	• <0.5 W
Earth Leakage Current	• 65/130 W: 260 µA at 264 VAC/60 Hz max 100 W: 230 µA at 264 VAC/60 Hz max
Input Protection	• Internal T3.15 A/250 V fuse in line and neutral

Output

Output Voltage	• 12-48 VDC (see tables)
Output Voltage Trim	• ±10%
Initial Set Accuracy	• ±1%
Minimum Load	• No minimum load required
Start Up Delay	• 1 s typical
Start Up Rise Time	• 50 ms
Hold Up Time	• 16 ms min at 115 VAC
Drift	• ±0.2% after 20 min warm up
Line Regulation	• ±0.5% max
Load Regulation	• ±1%
Over/Undershoot	• 5% typical
Transient Response	• 4% max. deviation, recovery to within 1% in 500 µs for a 50-75-50% load change
Ripple & Noise	• 1% pk-pk, 20 MHz bandwidth
Overvoltage Protection	• 115-140% Vnom, recycle input to reset
Overload Protection	• 110-160%
Short Circuit Protection	• Continuous trip and restart (hiccup mode)
Temperature Coefficient	• 0.05%/°C

Notes

1. ECS65US12 has 400Hz IT approval.

General

Efficiency	• Up to 90% model dependent
Isolation	• 4000 VAC Input to Output, 2 x MOPP, 1500 VAC Input to Ground, 1 x MOPP, 500 VDC Output to Ground, 1 x MOPP
Switching Frequency	• 65 KHz typical
Power Density	• 65 W: 7.7 W/in ³ , 100 W: 10 W/in ³ , 130 W: 13 W/in ³
MTBF	• 65 W: 850 kHrs, 100 W: 834 kHrs, 130 W: 715 kHrs to MIL-HDBK-217F at 25 °C, GB

Environmental

Operating Temperature	• -20 °C (-40 °C, ECS130) to +70 °C derate linearly from +50 °C at 2.5%/°C to 50% load at +70 °C.
Cooling	• Convection & fan cooled ratings (see tables)
Operating Humidity	• 95% RH, non-condensing
Storage Temperature	• -40 °C to +85 °C
Operating Altitude	• 65-100 W: 3000 m, 130 W: 5000m
Shock	• 30 g pk, half sine, 6 axes
Vibration	• 2 g rms, 5 Hz to 500 Hz, 3 axes

EMC & Safety

Low Voltage PSU EMC Emissions	• EN61204-3, high severity level • EN55011/32 level B conducted EN55011/32 level A radiated, level B Suffix '-B' models
Harmonic Currents	• EN61000-3-2, class A
Voltage Flicker	• EN61000-3-3
ESD Immunity	• EN61000-4-2, ±6 kV Contact, ±15 kV Air Discharge, Perf Criteria A
Radiated Immunity	• EN61000-4-3, level 3 Perf Criteria A
EFT/Burst	• EN61000-4-4, level 3 Perf Criteria A
Surge	• EN61000-4-5, installation class 3 Perf Criteria A
Conducted Immunity	• EN61000-4-6, level 3 Perf Criteria A
Dips & Interruptions	• EN61000-4-11, 30% 10 ms, 60% 100 ms, 100% 5000 ms, Perf Criteria A, B, B, EN60601-1-2, 30% 500 ms, 60% 100 ms, 100% 10 ms, 100% 5000 ms, Perf Criteria A, A, A, B - 230 VAC. Consult longform datasheet for 115 V operation.
Safety Approvals	• IEC60950-1:2005 Ed 2 / IEC62368-1:2014 UL 62368-1 & CAN/CSA C22.2 No. 62368-1-14, EN62368-1:2014/A11:2017 IEC60601-1 CB report, CSA 22.2 No. 60601-1, ANSI/AMMI ES60601-1, TUV 60601-1, including risk management, CE & UKCA meets all applicable directives & legislation.
Equipment Protection Class	• Class I & II (ECS65 Non '-B' models, Class I only)

Output Power	Output Voltage	Output Current	Model Number ⁽¹⁾
65 W	12.0 VDC	5.4 A	ECS65US12
65 W	15.0 VDC	4.3 A	ECS65US15
65 W	18.5 VDC	3.4 A	ECS65US18
65 W	24.0 VDC	2.7 A	ECS65US24
65 W	28.0 VDC	2.3 A	ECS65US28
65 W	48.0 VDC	1.4 A	ECS65US48

Notes

1. For Class B radiated emissions models, add suffix -B to model number. For covered versions, add suffix '-C' to model number or order part no. ECM40/60 COVER for standalone cover. Derate output power by 20% with cover. The cover is not suitable for Class II installations.

Mechanical Details

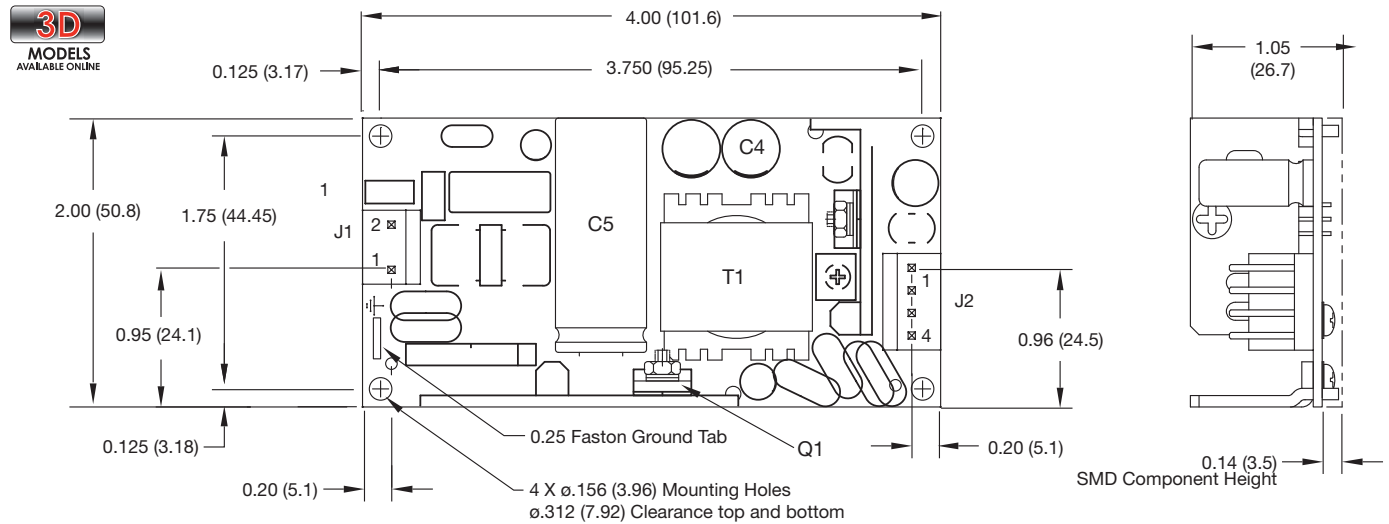

Input Connector J1 Molex PN 09-65-2038	
Pin 1	Line
Pin 2	Neutral
0.25" Faston	Earth

Output Connector J2 Molex PN 09-65-2048	
Pin 1	+V1
Pin 2	+V1
Pin 3	RTN
Pin 4	RTN

J1 mates with Molex Housing PN 09-50-1031, J2 mates with Molex Housing PN 09-50-1041 and both with Molex Series 5194 Crimp Terminals

Notes

- 1. All dimensions in inches (mm). Tolerance .xx = ±0.02 (0.50); .xxx = ±0.01 (0.25)
- 2. Weight: 0.386 lbs (175 g)

Derating Curve - ECS65 Models

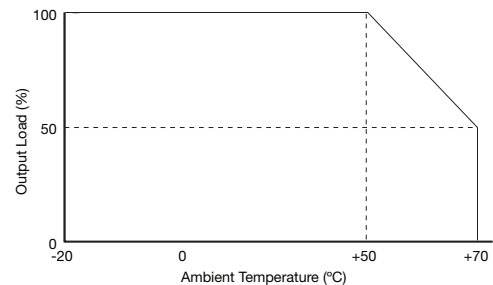
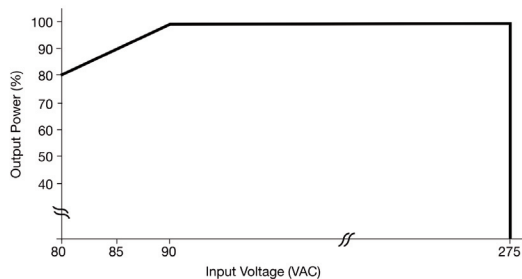

Output Power		Output Voltage	Output Current	Model Number ⁽¹⁾
Forced Cooled (10 CFM)	Convection-cooled			
100 W	80 W	12.0 VDC	8.3 A	ECS100US12
100 W	80 W	15.0 VDC	6.7 A	ECS100US15
100 W	80 W	18.0 VDC	5.5 A	ECS100US18
100 W	80 W	24.0 VDC	4.2 A	ECS100US24
100 W	80 W	28.0 VDC	3.6 A	ECS100US28
100 W	80 W	48.0 VDC	2.1 A	ECS100US48

Notes

1. For Class B radiated emissions models, add suffix -B to model number. For covered versions, add suffix '-C' to model number or order part no. ECM40/60 COVER for standalone cover. Derate output power by 20% with cover. The cover is not suitable for Class II installations. '-C' not available for '-B' models.

Mechanical Details

Pin 1	+V1
Pin 2	+V1
Pin 3	RTN
Pin 4	RTN

Pin 1	Line
Pin 2	Neutral
0.25" Faston	Earth

'-B' Model

Notes

- All dimensions in inches (mm). Tolerance .xx = ±0.02 (0.50); .xxx = ±0.01 (0.25)
- Weight: 0.386 lbs (175 g)

Derating Curve - ECS100 Models

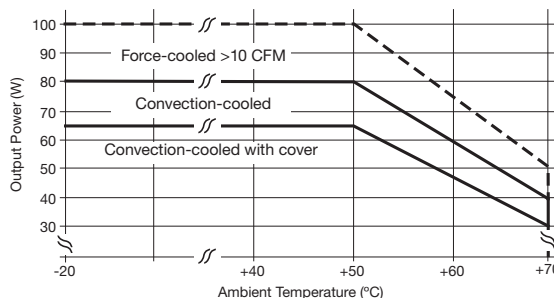
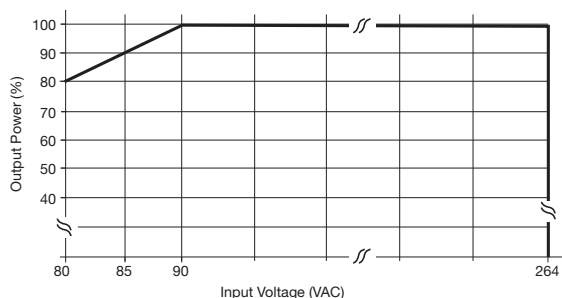

Models and Ratings

Output Power		Output Voltage	Output Current	Model Number ⁽¹⁾
Forced Cooled (10 CFM)	Convection-cooled			
130 W	100 W	12.0 VDC	10.9 A	ECS130US12
130 W	100 W	15.0 VDC	8.7 A	ECS130US15
130 W	100 W	18.0 VDC	7.3 A	ECS130US18
130 W	100 W	24.0 VDC	5.4 A	ECS130US24
130 W	100 W	28.0 VDC	4.7 A	ECS130US28
130 W	100 W	48.0 VDC	2.7 A	ECS130US48

Notes

1. For covered versions, add suffix '-C' to model number or order part no. ECM40/60 COVER for standalone cover, see derating curve. The cover is not suitable for Class II installations. '-C'.

Mechanical Details

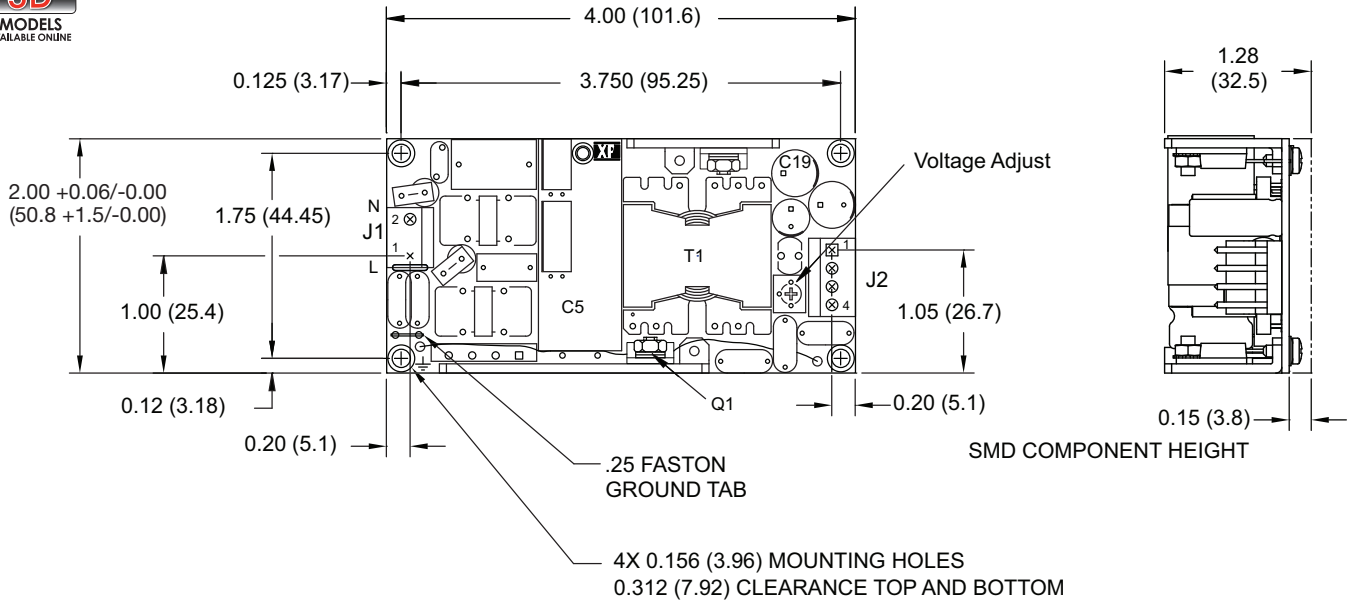

Input Connector J1 Molex PN 09-65-2038	
Pin 1	Line
Pin 2	Neutral
0.25" Faston	Earth

Notes

- All dimensions in inches (mm).
Tolerance .xx = ±0.02 (0.50); .xxx = ±0.01 (0.25)
- Weight: 0.386 lbs (175 g)

Output Connector J2 Molex PN 09-65-2048	
Pin 1	+V1
Pin 2	+V1
Pin 3	RTN
Pin 4	RTN

J1 mates with Molex Housing PN 09-50-1031, J2 mates with Molex Housing PN 09-50-1041 and both with Molex Series 5194 Crimp Terminals

Derating Curve - ECS130 Models

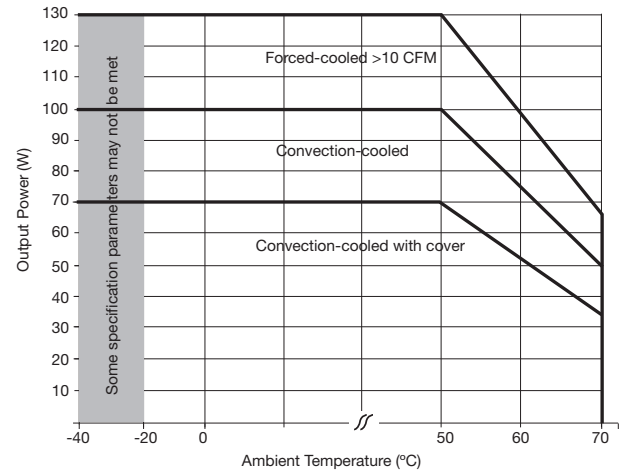
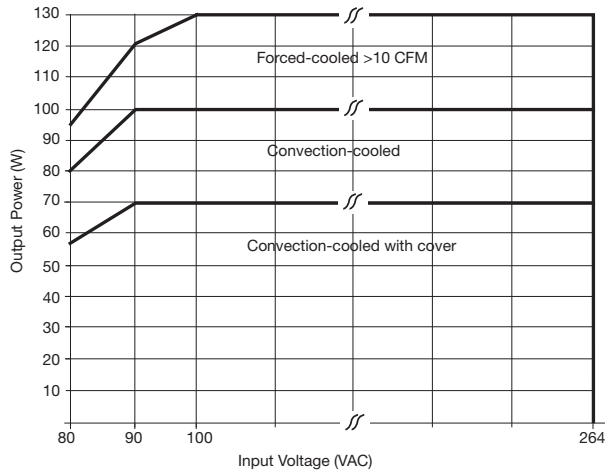

Covered Version (not available for ECS100-B Models)

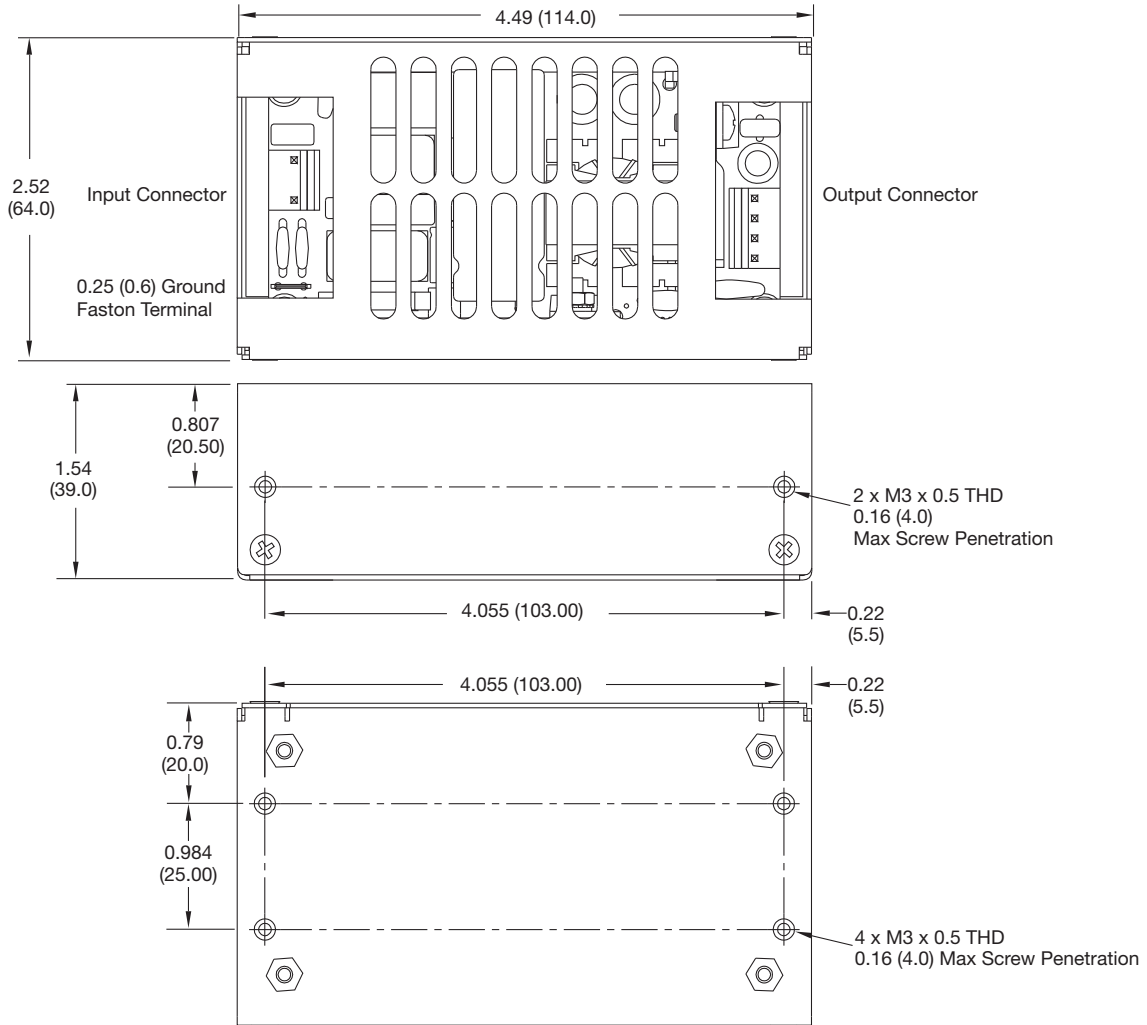

Notes

- 1. All dimensions in inches (mm).
Tolerance .xx = ±0.02 (0.50); .xxx = ±0.01 (0.25)
- 2. Weight: 0.8 lbs (360 g)

Thermal Considerations - All Models

In order to ensure safe operation of the PSU in the most adverse conditions permitted in the end-use equipment, the temperature of the components listed in the table below must not be exceeded. See mechanical drawing for component locations. Temperature should be monitored using K type thermocouples placed on the hottest part of the component (out of any direct air flow).

Temperature Measurements (Ambient ≤ 50 °C)	
Component	Max Temperature °C
T1	110 °C
C5	100 °C
C4/C19	100 °C
Q1	110 °C