

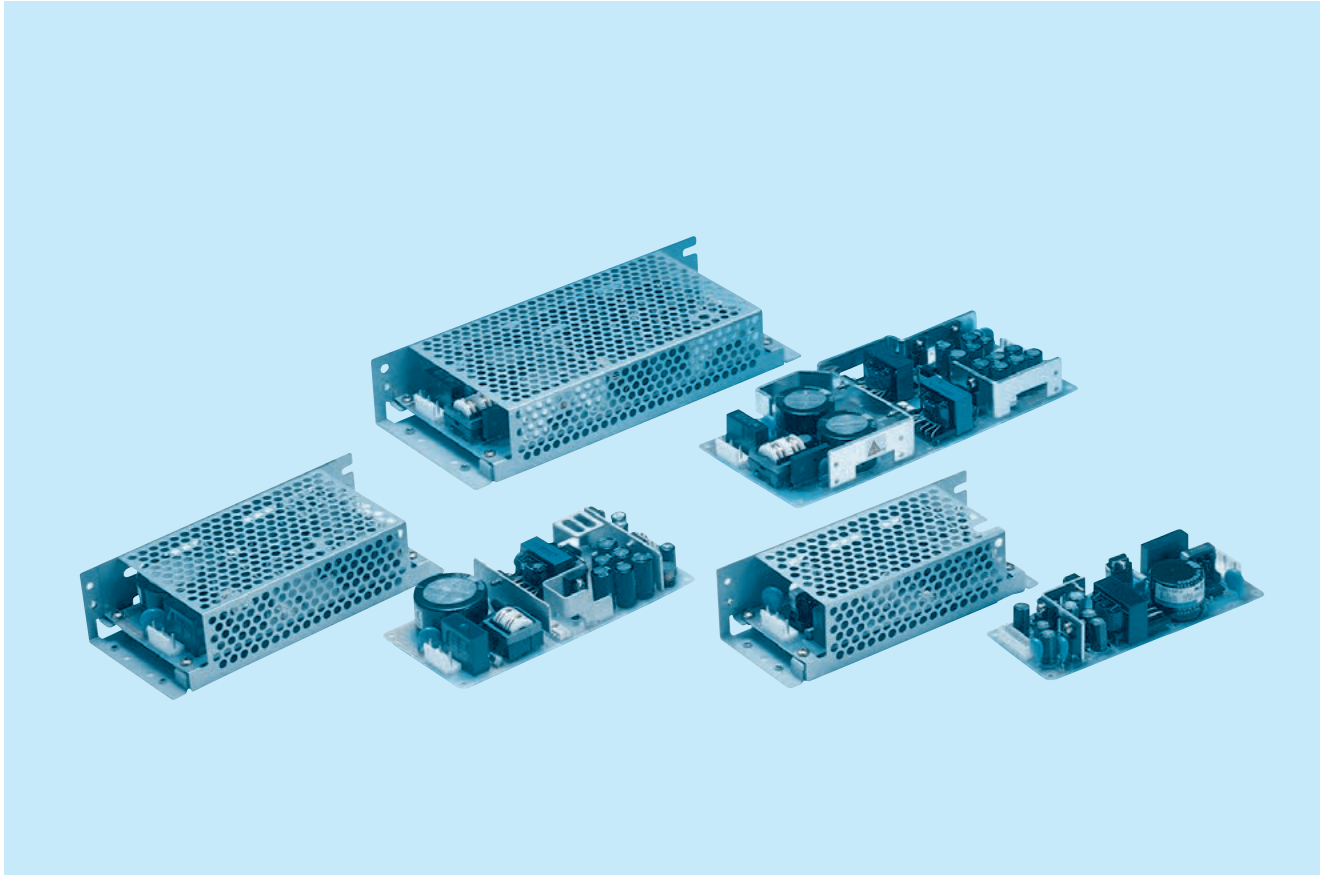

LDC-series



■ Feature

Small and compact PCB construction
 Universal input voltage (AC85 - 264V)
 UL recognized, TÜV approved, CSA certified
 Built-in inrush current, overcurrent and overvoltage protection circuits

■ Safety agency approvals

UL60950-1, CSA C22.2 No.60950-1, EN60950-1, EN50178
 Complies with DEN-AN

■ EMI

FCC-B, VCCI-B, CISPR22-B, EN55022-B

■ 2-year warranty

■ Optional parts

Optional parts	Model	Remarks
Chassis and cover	LDC15F, LDC30F, LDC60F	
Harness for-J type	LDC15F, LDC30F, LDC60F	Refer to page of optional parts

■ CE marking

Low Voltage Directive
 RoHS Directive

■ UKCA marking

Electrical Equipment Safety Regulations
 RoHS Regulations

LDC15F

LD C 15 F -1 -□

① ② ③ ④ ⑤ ⑥

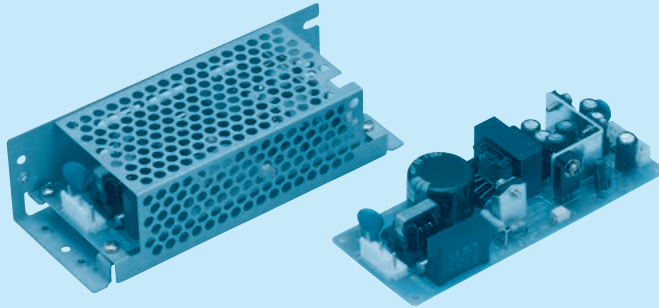

- ① Series name
- ② Multiple output
- ③ Output wattage
- ④ Universal input
- ⑤ Output voltage combination
- ⑥ Optional *4
 C : with Coating
 G : Low leakage current
 S : with Chassis
 SN : with Chassis & cover
 Y : with Potentiometer

MODEL	LDC15F-1		LDC15F-2	
DC OUTPUT	V1	+5V 2.0(Peak 3.0)A	+5V 2.0(Peak 3.0)A	
	V2	+12V 0.3(Peak 0.6)A	+15V 0.3(Peak 0.6)A	
	V3	-12V 0.2(Peak 0.3)A	-15V 0.2(Peak 0.3)A	

SPECIFICATIONS

	MODEL	LDC15F-1			LDC15F-2			
INPUT	VOLTAGE[V]	AC85 - 264 1φ or DC110 - 370						
	CURRENT[A]	ACIN 100V	0.4typ (Io=100%)					
	FREQUENCY[Hz]	47 - 440 or DC						
	EFFICIENCY[%]	ACIN 100V	70typ (Io=100%)					
	INRUSH CURRENT[A]	ACIN 100V	25typ (Io=100%)					
		ACIN 200V	50typ (Io=100%)					
LEAKAGE CURRENT[ma]	0.75max (60Hz, According to UL, CSA, VDE and DEN-AN)							
OUTPUT	VOLTAGE[V]	+5	+12	-12	+5	+15	-15	
	CURRENT[A]	*1 0 - 2.0 (Peak 3.0)	0 - 0.3 (Peak 0.6)	0 - 0.2 (Peak 0.3)	0 - 2.0 (Peak 3.0)	0 - 0.3 (Peak 0.6)	0 - 0.2 (Peak 0.3)	
	LINE REGULATION[mV]	20max	48max	48max	20max	60max	60max	
	LOAD REGULATION[mV]	100max	120max	120max	100max	150max	150max	
	RIPPLE[mVp-p]	0 to +50°C *2	100max	120max	120max	100max	120max	120max
		-10 - 0°C *2	140max	160max	160max	140max	160max	160max
	RIPPLE NOISE[mVp-p]	0 to +50°C *2	120max	150max	150max	120max	150max	150max
		-10 - 0°C *2	160max	180max	180max	160max	180max	180max
	TEMPERATURE REGULATION[mV]	0 to +50°C	50max	350max	350max	50max	350max	350max
		-10 to +50°C	60max	420max	420max	60max	420max	420max
	DRIFT[mV]	*3 20max	—	—	20max	—	—	
	START-UP TIME[ms]	100max (ACIN 85V, Io=100%)						
	HOLD-UP TIME[ms]	10typ (ACIN 85V, Io=100%), 20typ (ACIN 100V, Io=100%), 100typ (ACIN 200V, Io=100%)						
OUTPUT VOLTAGE ADJUSTMENT RANGE[V]	Fixed	Fixed	Fixed	Fixed	Fixed	Fixed		
OUTPUT VOLTAGE SETTING[V]	4.9 to 5.3	11.4 to 12.6	-11.4 to -12.6	4.9 to 5.3	14.25 to 15.75	-14.25 to -15.75		
PROTECTION CIRCUIT AND OTHERS	OVERCURRENT PROTECTION	Works over 105% of rating and recovers automatically						
	OVERVOLTAGE PROTECTION	Works over 115% of rating by zener diode clamping (+5V only)						
	OPERATING INDICATION	Not provided						
	REMOTE SENSING	Not provided						
REMOTE ON/OFF	Not provided							
ISOLATION	INPUT-OUTPUT	AC3,000V 1minute, Cutoff current = 10mA, DC500V 50MΩ min (At Room Temperature)						
	INPUT-FG	AC2,000V 1minute, Cutoff current = 10mA, DC500V 50MΩ min (At Room Temperature)						
	OUTPUT-FG	AC500V 1minute, Cutoff current = 100mA, DC500V 50MΩ min (At Room Temperature)						
	OUTPUT-OUTPUT(V1-V2,V3)	AC100V 1minute, Cutoff current = 100mA, DC100V 10MΩ min (At Room Temperature)						
ENVIRONMENT	OPERATING TEMP., HUMID. AND ALTITUDE	-10 to +60°C, 20 - 90%RH (Non condensing) (Refer to DERATING CURVE), 3,000m (10,000feet)						
	STORAGE TEMP., HUMID. AND ALTITUDE	-20 to +75°C, 20 - 90%RH (Non condensing), 9,000m (30,000feet)						
	VIBRATION	10 - 55Hz, 19.6m/s ² (2G), 3minutes period, 60minutes each along X, Y and Z axis						
SAFETY AND NOISE REGULATIONS	IMPACT	196.1m/s ² (20G), 11ms, once each X, Y and Z axis						
	AGENCY APPROVALS	UL60950-1, EN60950-1, EN50178, CSA C22.2 No.60950-1 Complies with DEN-AN and IEC60950-1						
CONDUCTED NOISE	Complies with FCC-B, CISPR22-B, EN55022-B, VCCI-B							
OTHERS	CASE SIZE/WEIGHT	50 X 26 X 127mm [1.97 X 1.02 X 5 inches] (W X H X D) /150g max (with chassis & cover : 300g max)						
	COOLING METHOD	Convection						

*1 Peak load for 10sec. or less is acceptable if the total wattage is less than the rated wattage(-1: 16W, -2: 17.5W). When the load of +5V is OA, other output can be drawn by 80% of rated current.
 *2 Measured by 20MHz oscilloscope or Ripple-Noise meter (equivalent to KEISOKU-GIKEN:RM101).
 *3 Drift is the change in DC output for an eight hour period after a half-hour warm-up at 25°C with the input voltage held constant at the rated input/output.
 *4 Please contact us about safety approvals for the model with option.
 * Avoid prolonged use under over-load.
 * Derating is required when operated with chassis and cover.

External view

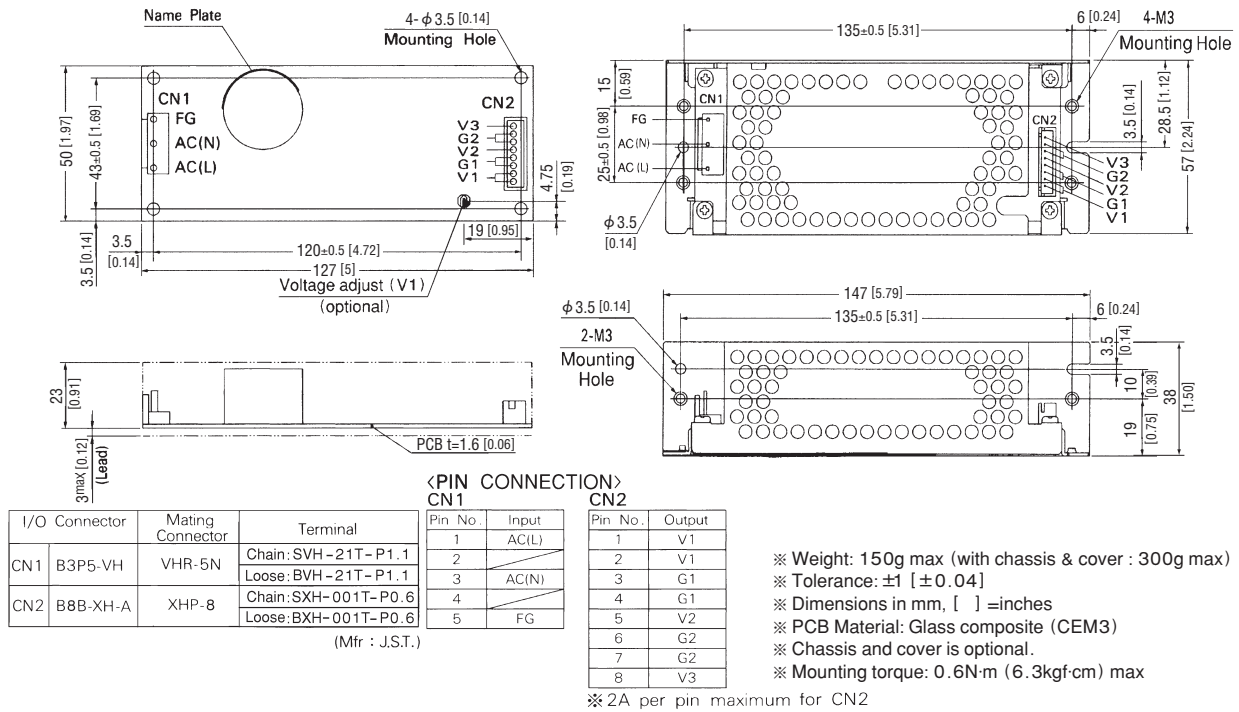

Performance data

■ STATIC CHARACTERISTICS (LDC15F-1)

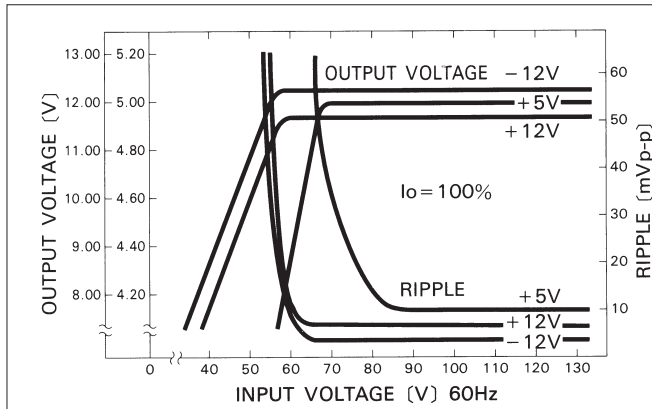

■ RISE TIME & FALL TIME (LDC15F-1)

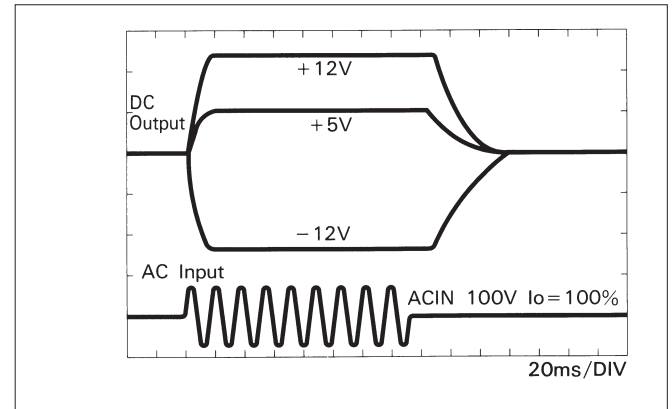

■ OVERCURRENT CHARACTERISTICS (LDC15F-1)

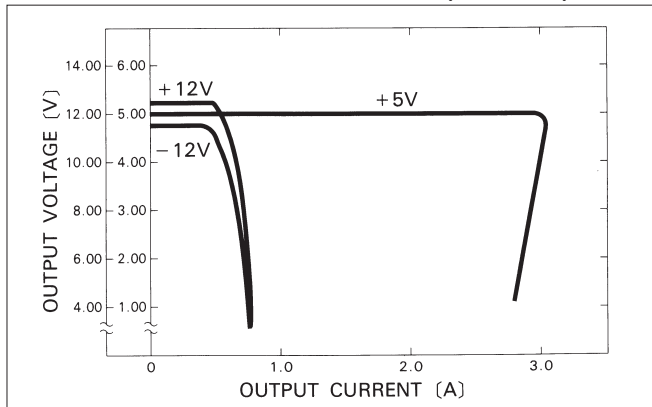

■ DERATING CURVE

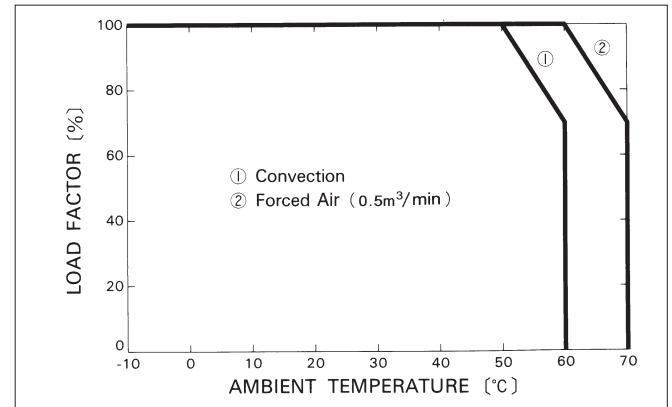

LDC30F

LD C 30 F -1 -□

① ② ③ ④ ⑤ ⑥

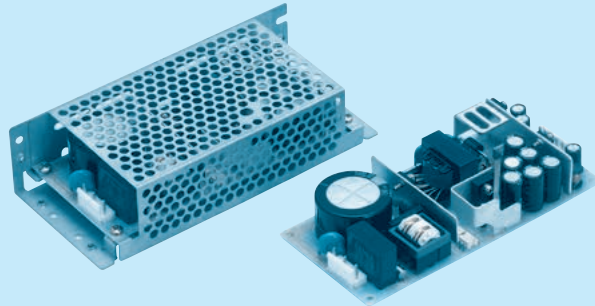

- ① Series name
- ② Multiple output
- ③ Output wattage
- ④ Universal input
- ⑤ Output voltage combination
- ⑥ Optional *4
 C : with Coating
 G : Low leakage current
 S : with Chassis
 SN : with Chassis & cover
 Y : with Potentiometer

MODEL	LDC30F-1	LDC30F-2
DC OUTPUT	V1 +5V 3.0(Peak 4.5)A V2 +12V 1.2(Peak 2.0)A V3 -12V 0.3(Peak 0.45)A	+5V 3.0(Peak 4.5)A +15V 1.0(Peak 2.0)A -15V 0.3(Peak 0.45)A

SPECIFICATIONS

	MODEL	LDC30F-1	LDC30F-2					
INPUT	VOLTAGE[V]	AC85 - 264 1 φ or DC110 - 370						
	CURRENT[A]	ACIN 100V	0.8typ (Io=100%)					
	FREQUENCY[Hz]		47 - 440 or DC					
	EFFICIENCY[%]	ACIN 100V	72typ (Io=100%)					
	INRUSH CURRENT[A]	ACIN 100V	25typ (Io=100%) (At cold start)					
		ACIN 200V	50typ (Io=100%) (At cold start)					
LEAKAGE CURRENT[ma]		0.75max (60Hz, According to UL, CSA, VDE and DEN-AN)						
OUTPUT	VOLTAGE[V]	+5	+12	-12	+5	+15	-15	
	CURRENT[A]	*1 0 - 3.0 (Peak 4.5)	0 - 1.2 (Peak 2.0)	0 - 0.3 (Peak 0.45)	0 - 3.0 (Peak 4.5)	0 - 1.0 (Peak 2.0)	0 - 0.3 (Peak 0.45)	
	LINE REGULATION[mV]	20max	48max	48max	20max	60max	60max	
	LOAD REGULATION[mV]	100max	120max	150max	100max	120max	150max	
	RIPPLE[mVp-p]	0 to +50°C *2	100max	120max	120max	100max	120max	120max
		-10 - 0°C *2	150max	160max	160max	150max	160max	160max
	RIPPLE NOISE[mVp-p]	0 to +50°C *2	120max	150max	150max	120max	150max	150max
		-10 - 0°C *2	170max	180max	180max	170max	180max	180max
	TEMPERATURE REGULATION[mV]	0 to +50°C	50max	350max	350max	50max	350max	350max
		-10 to +50°C	60max	420max	420max	60max	420max	420max
	DRIFT[mV]	*3 20max	—	—	20max	—	—	
	START-UP TIME[ms]	100max (ACIN 85V, Io=100%)						
	HOLD-UP TIME[ms]	10typ (ACIN 85V, Io=100%), 20typ (ACIN 100V, Io=100%), 100typ (ACIN 200V, Io=100%)						
OUTPUT VOLTAGE ADJUSTMENT RANGE[V]	Fixed	Fixed	Fixed	Fixed	Fixed	Fixed		
OUTPUT VOLTAGE SETTING[V]	4.9 to 5.3	11.4 to 12.6	-11.4 to -12.6	4.9 to 5.3	14.25 to 15.75	-14.25 to -15.75		
PROTECTION CIRCUIT AND OTHERS	OVERCURRENT PROTECTION	Works over 105% of rating and recovers automatically						
	OVERVOLTAGE PROTECTION	Works at 115 - 140% of rating (+5V only)						
	OPERATING INDICATION	Not provided						
	REMOTE SENSING	Not provided						
REMOTE ON/OFF	Not provided							
ISOLATION	INPUT-OUTPUT	AC3,000V 1minute, Cutoff current = 10mA, DC500V 50MΩ min (At Room Temperature)						
	INPUT-FG	AC2,000V 1minute, Cutoff current = 10mA, DC500V 50MΩ min (At Room Temperature)						
	OUTPUT-FG	AC500V 1minute, Cutoff current = 100mA, DC500V 50MΩ min (At Room Temperature)						
	OUTPUT-OUTPUT(V1-V2,V3)	AC100V 1minute, Cutoff current = 100mA, DC100V 10MΩ min (At Room Temperature)						
ENVIRONMENT	OPERATING TEMP., HUMID. AND ALTITUDE	-10 to +60°C, 20 - 90%RH (Non condensing) (Refer to DERATING CURVE), 3,000m (10,000feet)						
	STORAGE TEMP., HUMID. AND ALTITUDE	-20 to +75°C, 20 - 90%RH (Non condensing), 9,000m (30,000feet)						
	VIBRATION	10 - 55Hz, 19.6m/s ² (2G), 3minutes period, 60minutes each along X, Y and Z axis						
SAFETY AND NOISE REGULATIONS	IMPACT	196.1m/s ² (20G), 11ms, once each X, Y and Z axis						
	AGENCY APPROVALS	UL60950-1, EN60950-1, EN50178, CSA C22.2 No.60950-1 Complies with DEN-AN and IEC60950-1						
OTHERS	CONDUCTED NOISE	Complies with FCC-B, CISPR22-B, EN55022-B, VCCI-B						
OTHERS	CASE SIZE/WEIGHT	65 X 26 X 140mm [2.56 X 1.02 X 5.51 inches] (W X H X D) / 220g max (with chassis & cover : 400g max)						
	COOLING METHOD	Convection						

*1 Peak load for 10sec. or less is acceptable if the total wattage is less than the rated wattage(-1: 33W, -2: 34.5W). When the load of +5V is OA, other output can be drawn by 80% of rated current.
 *2 Measured by 20MHz oscilloscope or Ripple-Noise meter (equivalent to KEISOKU-GIKEN:RM101).
 *3 Drift is the change in DC output for an eight hour period after a half-hour warm-up at 25°C with the input voltage held constant at the rated input/output.
 *4 Please contact us about safety approvals for the model with option.
 * Avoid prolonged use under over-load.
 * Derating is required when operated with chassis and cover.

External view

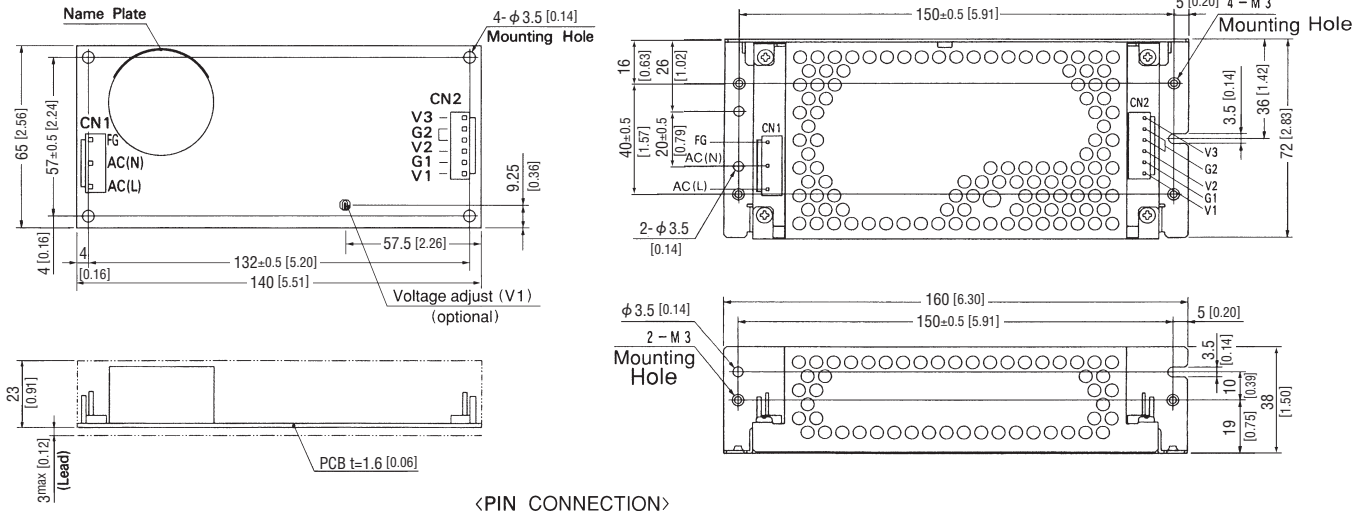

<PIN CONNECTION>

I/O Connector	Mating Connector	Terminal	
CN1	B3P5-VH	VHR-5N	Chain:SVH-21T-P1.1
			Loose:BVH-21T-P1.1
CN2	B6P-VH	VHR-6N	Chain:SVH-21T-P1.1
			Loose:BVH-21T-P1.1

(Mfr : J.S.T.)

CN1	
Pin No.	Input
1	AC(L)
2	
3	AC(N)
4	
5	FG

CN2	
Pin No.	Output
1	V3
2	G2
3	G2
4	V2
5	G1
6	V1

- ※ Weight: 220g max (with chassis & cover : 400g max)
- ※ Tolerance: ± 1 [± 0.04]
- ※ Dimensions in mm, [] =inches
- ※ PCB Material: Glass composite (CEM3)
- ※ Chassis and cover is optional.
- ※ Mounting torque: 0.6N-m (6.3kgf-cm) max

Performance data

■ STATIC CHARACTERISTICS (LDC30F-1)

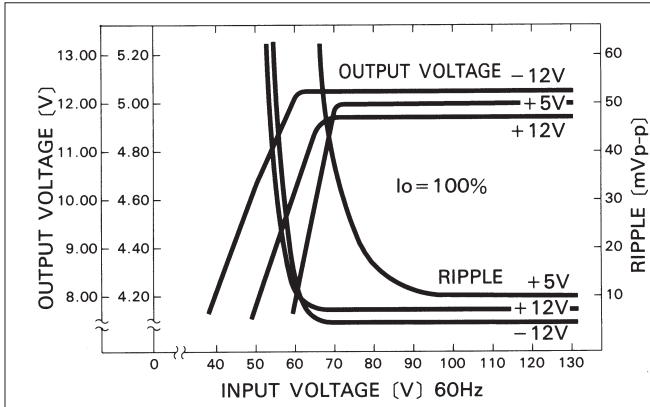

■ RISE TIME & FALL TIME (LDC30F-1)

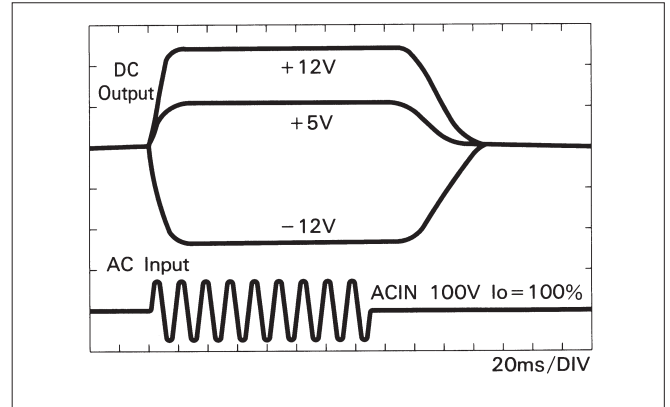

■ OVERCURRENT CHARACTERISTICS (LDC30F-1)

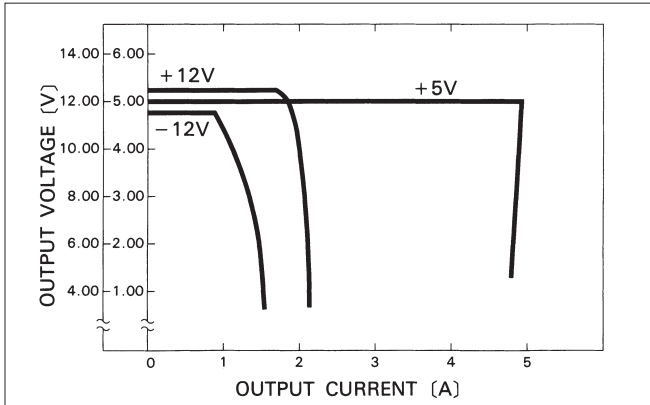

■ DERATING CURVE

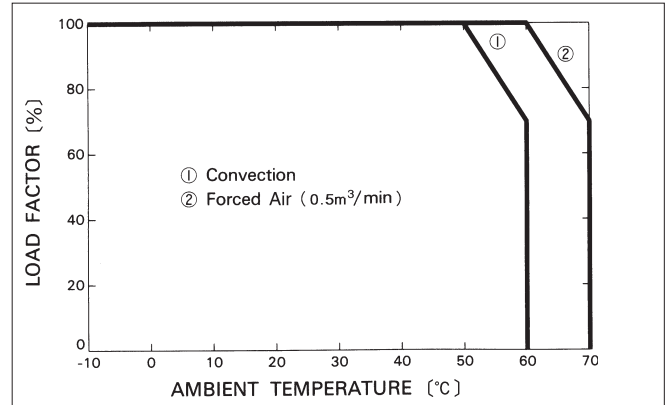

LDC60F

LD C 60 F -1 -□

① ② ③ ④ ⑤ ⑥

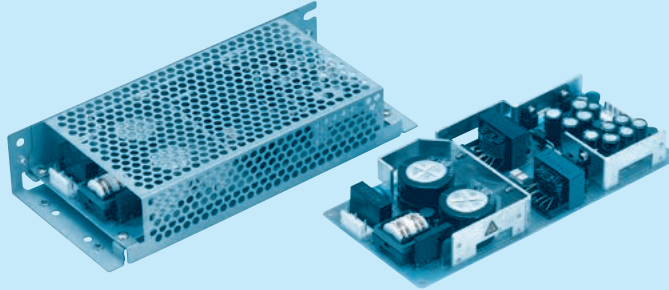

- ① Series name
- ② Multiple output
- ③ Output wattage
- ④ Universal input
- ⑤ Output voltage combination
- ⑥ Optional *4
 C : with Coating
 G : Low leakage current
 S : with Chassis
 SN : with Chassis & cover
 Y : with Potentiometer

MODEL	LDC60F-1		LDC60F-2	
DC OUTPUT	V1	+5V 5.0(Peak 7.0)A	+5V 5.0(Peak 7.0)A	
	V2	+12V 2.5(Peak 3.5)A	+15V 2.0(Peak 3.5)A	
	V3	-12V 0.5(Peak 0.7)A	-15V 0.5(Peak 0.7)A	

SPECIFICATIONS

	MODEL	LDC60F-1			LDC60F-2			
INPUT	VOLTAGE[V]	AC85 - 264 1 φ or DC110 - 370						
	CURRENT[A]	ACIN 100V	1.4typ (Io=100%)					
	FREQUENCY[Hz]	47 - 440 or DC						
	EFFICIENCY[%]	ACIN 100V	72typ (Io=100%)					
	INRUSH CURRENT[A]	ACIN 100V	30typ (Io=100%) (At cold start)					
		ACIN 200V	60typ (Io=100%) (At cold start)					
	LEAKAGE CURRENT[ma]	0.75max (60Hz, According to UL, CSA, VDE and DEN-AN)						
OUTPUT	VOLTAGE[V]	+5	+12	-12	+5	+15	-15	
	CURRENT[A]	*1 0 - 5.0 (Peak 7.0)	0 - 2.5 (Peak 3.5)	0 - 0.5 (Peak 0.7)	0 - 5.0 (Peak 7.0)	0 - 2.0 (Peak 3.5)	0 - 0.5 (Peak 0.7)	
	LINE REGULATION[mV]	20max	48max	48max	20max	60max	60max	
	LOAD REGULATION[mV]	100max	150max	150max	100max	150max	150max	
	RIPPLE[mVp-p]	0 to +50°C *2	100max	120max	120max	100max	120max	120max
		-10 - 0°C *2	150max	160max	160max	150max	160max	160max
	RIPPLE NOISE[mVp-p]	0 to +50°C *2	120max	150max	150max	120max	150max	150max
		-10 - 0°C *2	170max	180max	180max	170max	180max	180max
	TEMPERATURE REGULATION[mV]	0 to +50°C	50max	350max	350max	50max	350max	350max
		-10 to +50°C	60max	420max	420max	60max	420max	420max
	DRIFT[mV]	*3 20max	—	—	20max	—	—	
	START-UP TIME[ms]	200max (ACIN 85V, Io=100%)						
	HOLD-UP TIME[ms]	10typ (ACIN 85V, Io=100%), 20typ (ACIN 100V, Io=100%), 100typ (ACIN 200V, Io=100%)						
OUTPUT VOLTAGE ADJUSTMENT RANGE[V]	Fixed	Fixed	Fixed	Fixed	Fixed	Fixed		
OUTPUT VOLTAGE SETTING[V]	4.9 to 5.3	11.4 to 12.6	-11.4 to -12.6	4.9 to 5.3	14.25 to 15.75	-14.25 to -15.75		
PROTECTION CIRCUIT AND OTHERS	OVERCURRENT PROTECTION	Works over 105% of rating and recovers automatically						
	OVERVOLTAGE PROTECTION	Works over 115% of rating by zener diode clamping (only available with V1, V2)						
	OPERATING INDICATION	Not provided						
	REMOTE SENSING	Not provided						
REMOTE ON/OFF	Not provided							
ISOLATION	INPUT-OUTPUT	AC3,000V 1minute, Cutoff current = 10mA, DC500V 50MΩ min (At Room Temperature)						
	INPUT-FG	AC2,000V 1minute, Cutoff current = 10mA, DC500V 50MΩ min (At Room Temperature)						
	OUTPUT-FG	AC500V 1minute, Cutoff current = 100mA, DC500V 50MΩ min (At Room Temperature)						
	OUTPUT-OUTPUT(V1-V2,V3)	AC100V 1minute, Cutoff current = 100mA, DC100V 10MΩ min (At Room Temperature)						
ENVIRONMENT	OPERATING TEMP., HUMID. AND ALTITUDE	-10 to +60°C, 20 - 90%RH (Non condensing) (Refer to DERATING CURVE), 3,000m (10,000feet)						
	STORAGE TEMP., HUMID. AND ALTITUDE	-20 to +75°C, 20 - 90%RH (Non condensing), 9,000m (30,000feet)						
	VIBRATION	10 - 55Hz, 19.6m/s ² (2G), 3minutes period, 60minutes each along X, Y and Z axis						
SAFETY AND NOISE REGULATIONS	IMPACT	196.1m/s ² (20G), 11ms, once each X, Y and Z axis						
	AGENCY APPROVALS	UL60950-1, EN60950-1, EN50178, CSA C22.2 No.60950-1 Complies with DEN-AN and IEC60950-1						
OTHERS	CONDUCTED NOISE	Complies with FCC-B, CISPR22-B, EN55022-B, VCCI-B						
OTHERS	CASE SIZE/WEIGHT	83 x 26 x 185mm [3.27 x 1.02 x 7.28 inches] (W x H x D) / 300g max (with chassis & cover : 550g max)						
	COOLING METHOD	Convection						

*1 Peak load for 10sec. or less is acceptable if the total wattage is less than the rated wattage(-1: 61W, -2: 62.5W). When the load of +5V is OA, other output can be drawn by 80% of rated current.
 *2 Measured by 20MHz oscilloscope or Ripple-Noise meter (equivalent to KEISOKU-GIKEN:RM101).
 *3 Drift is the change in DC output for an eight hour period after a half-hour warm-up at 25°C with the input voltage held constant at the rated input/output.
 *4 Please contact us about safety approvals for the model with option.
 * Avoid prolonged use under over-load.
 * Derating is required when operated with chassis and cover.

External view

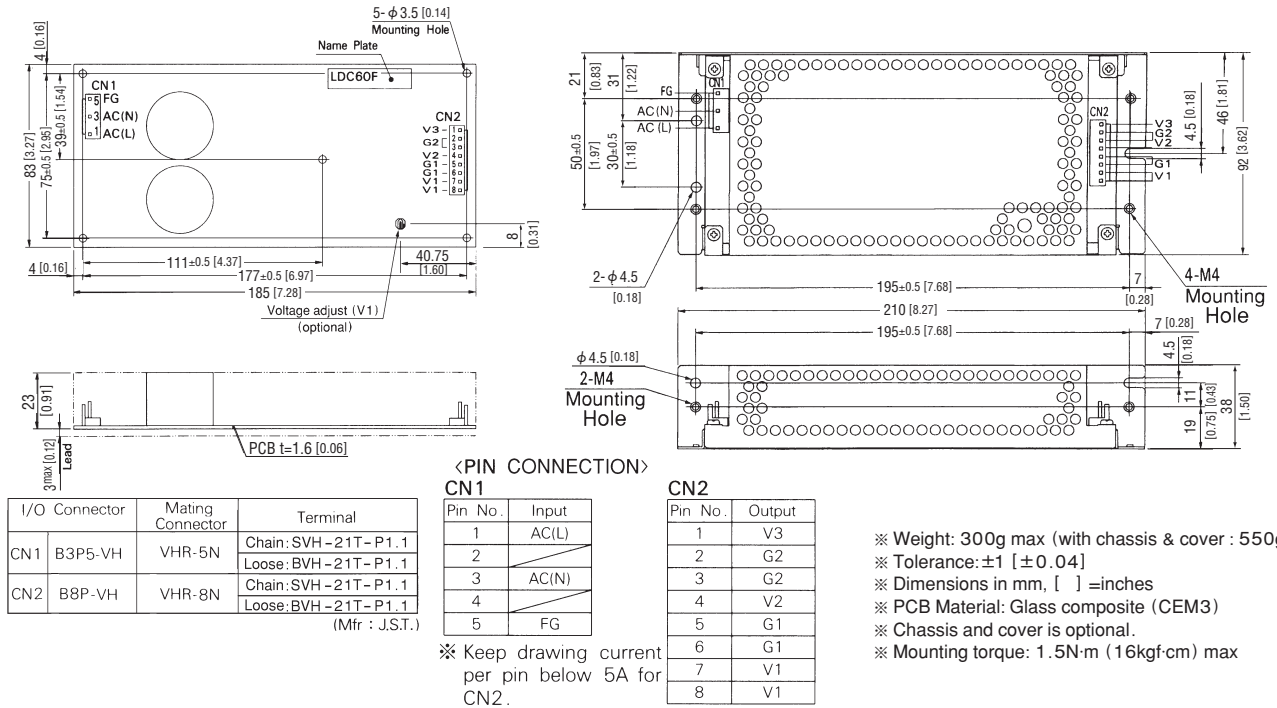

Performance data

■ STATIC CHARACTERISTICS (LDC60F-1)

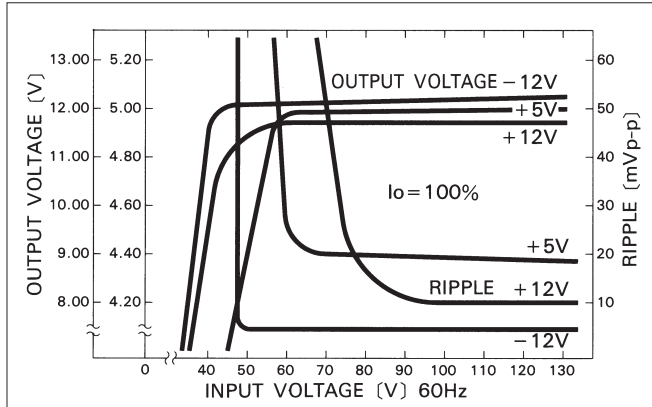

■ RISE TIME & FALL TIME (LDC60F-1)

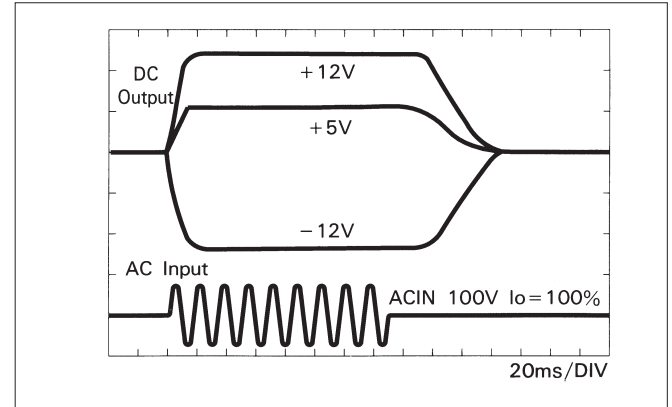

■ OVERCURRENT CHARACTERISTICS (LDC60F-1)

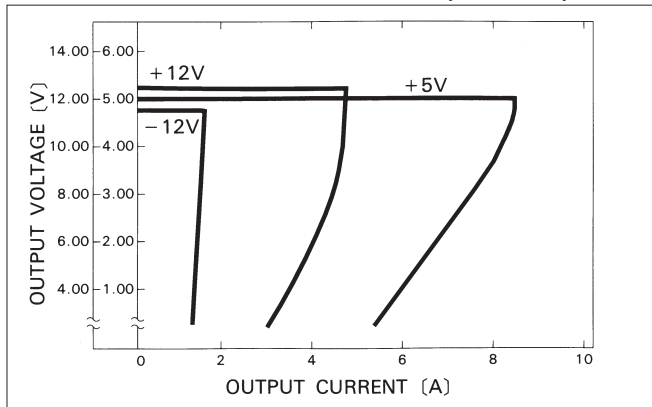

■ DERATING CURVE

