



Medical
electric
equipment



Power
Factor
Correction



World wide



Safety
Approvals



EMI



Inrush
current
limiting



OCP



OVP



Remote
ON/OFF

PMA-series

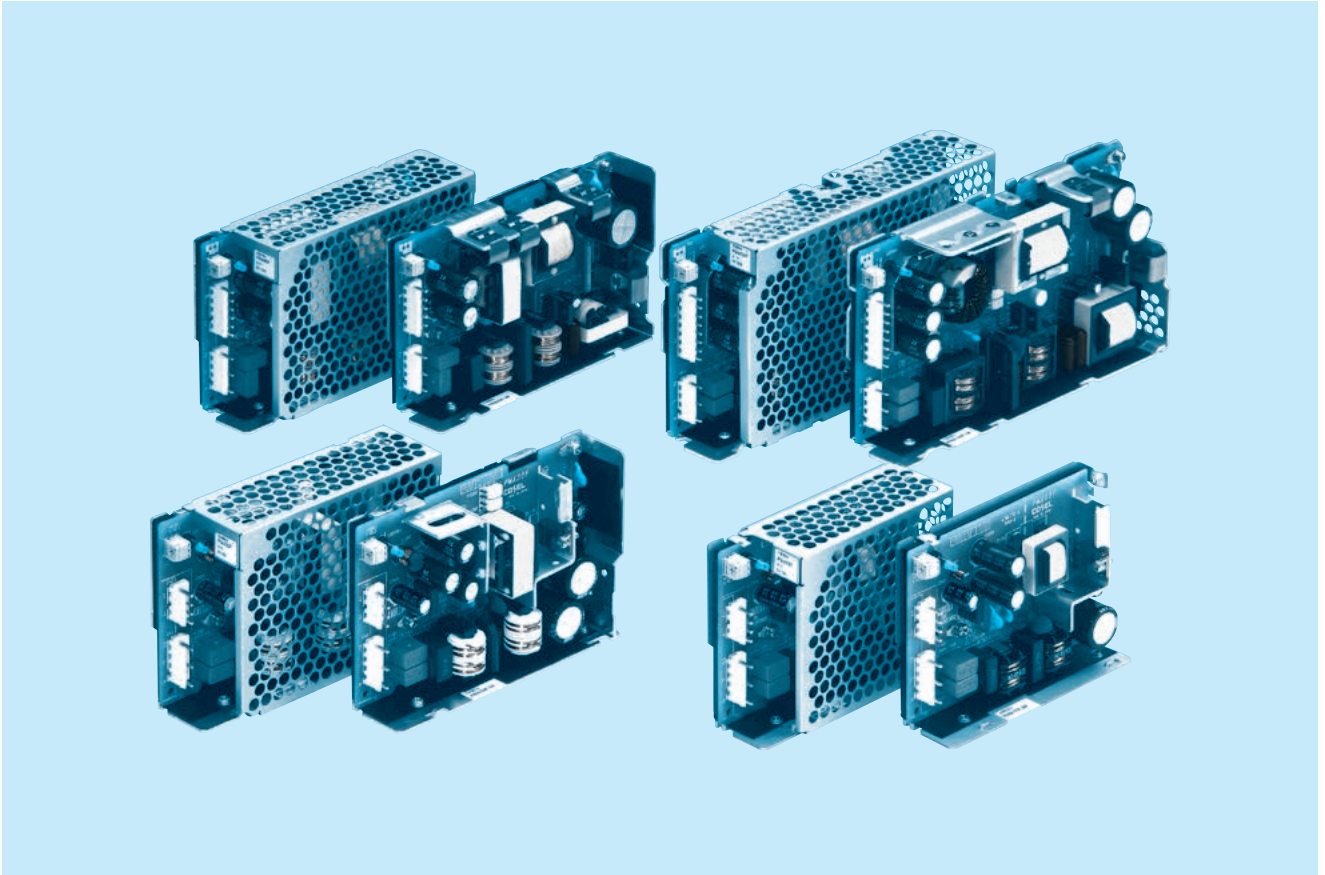

■ Feature

For medical electric equipment
Internal dual fuses
Harmonic attenuator (Complies with IEC61000-3-2)
Universal input (AC85 - 264V)
Efficiency increased with synchronous rectification technology (PMA60F, PMA100F)
Variety of option

■ Safety agency approvals

UL60601-1, C-UL (CSA-C22.2 No.601.1), EN60601-1

■ EMI

FCC-B, CISPR11-B, CISPR22-B, EN55011-B, EN55022-B, VCCI-B

■ 5-year warranty (refer to Instruction Manual)

■ CE marking

Low Voltage Directive
RoHS Directive

■ UKCA marking

Electrical Equipment Safety Regulations
RoHS Regulations

■ EMS Compliance : EN61204-3, EN61000-6-2

EN61000-4-2
EN61000-4-3
EN61000-4-4
EN61000-4-5 (Common mode Level4, Differential mode Level2)
EN61000-4-6
EN61000-4-8
EN61000-4-11

PMA15F

① PM ② A ③ 15 ④ F ⑤ -□ ⑥ -□

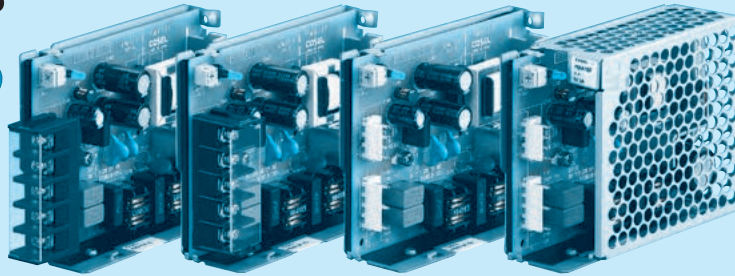

Horizontal terminal block (option : -T1) Vertical terminal block (option : -T) Standard type with Cover (option : -N)

Example recommended EMI/EMC filter
NAM-04-000



Low leakage current type : NAM series
* A higher current rating EMI/EMC filter may be recommended in view of the other devices that could be connected in parallel with the power supply.

- ① Series name
- ② Single output
- ③ Output wattage
- ④ Universal input
- ⑤ Output voltage
- ⑥ Optional *5
- T : Vertical terminal block
- T1 : Horizontal terminal block
- N : with Cover
- J1 : VH(J.S.T.)connector type

Specification is changed at option, refer to Instruction Manual.

*Make sure necessary tests will be carried out on your end equipment with the power supply installed in accordance with any required EMC/EMI regulations.

MODEL	PMA15F-3R3	PMA15F-5	PMA15F-12	PMA15F-15	PMA15F-24
MAX OUTPUT WATTAGE[W]	9.9	15	15.6	15	16.8
DC OUTPUT	3.3V 3A	5V 3A	12V 1.3A	15V 1A	24V 0.7A

SPECIFICATIONS

	MODEL	PMA15F-3R3	PMA15F-5	PMA15F-12	PMA15F-15	PMA15F-24	
INPUT	VOLTAGE[V]	AC85 - 264 1 φ (Refer to the Instruction Manual 1.1 and "Derating") *3					
	CURRENT[A]	ACIN 100V	0.30typ (Io=100%)	0.40typ (Io=100%)			
		ACIN 200V	0.15typ (Io=100%)	0.20typ (Io=100%)			
	FREQUENCY[Hz]	50 / 60 (47 - 440)					
	EFFICIENCY[%]	ACIN 100V	66typ	70typ	74typ	76typ	76typ
		ACIN 200V	67typ	74typ	78typ	79typ	79typ
INRUSH CURRENT[A]	ACIN 100V	15typ (Io=100%) (At cold start)					
	ACIN 200V	30typ (Io=100%) (At cold start)					
LEAKAGE CURRENT[mA]	0.05/0.10max (ACIN 100V / 240V 60Hz, Io=100%, According to IEC60601-1)						
OUTPUT	VOLTAGE[V]	3.3	5	12	15	24	
	CURRENT[A]	3.0	3.0	1.3	1.0	0.7	
	LINE REGULATION[mV]	20max	20max	48max	60max	96max	
	LOAD REGULATION[mV]	40max	40max	100max	120max	150max	
	RIPPLE[mVp-p]	0 to +50°C	80max	80max	120max	120max	120max
		-10 - 0°C	140max	140max	160max	160max	160max
	RIPPLE NOISE[mVp-p]	0 to +50°C	120max	120max	150max	150max	150max
		-10 - 0°C	160max	160max	180max	180max	180max
	TEMPERATURE REGULATION[mV]	0 to +50°C	50max	50max	120max	150max	240max
		-10 to +50°C	60max	60max	150max	180max	290max
	DRIFT[mV]	*2	20max	20max	48max	60max	96max
START-UP TIME[ms]	200typ (ACIN 100V, Io=100%) *Start-up time is 700ms typ for less than 1minute of applying input again from turning off the input voltage.						
HOLD-UP TIME[ms]	20typ (ACIN 100V, Io=100%)						
OUTPUT VOLTAGE ADJUSTMENT RANGE[V]	2.85 to 3.60	4.50 to 5.50	10.00 to 13.20	13.20 to 18.00	19.20 to 27.00		
OUTPUT VOLTAGE SETTING[V]	3.30 to 3.40	5.00 to 5.15	12.00 to 12.48	15.00 to 15.60	24.00 to 24.96		
PROTECTION CIRCUIT AND OTHERS	OVERCURRENT PROTECTION	Works over 105% of rating and recovers automatically					
	OVERVOLTAGE PROTECTION[V]	4.00 to 5.25	5.75 to 7.00	15.00 to 18.00	20.00 to 25.00	30.00 to 37.00	
	OPERATING INDICATION	LED (Green)					
	REMOTE ON/OFF	Not provided					
ISOLATION	INPUT-OUTPUT	AC4,000V 1minute, Cutoff current = 10mA, DC500V 50MΩ min (At Room Temperature)					
	INPUT-FG	AC2,000V 1minute, Cutoff current = 10mA, DC500V 50MΩ min (At Room Temperature)					
	OUTPUT-FG	AC500V 1minute, Cutoff current = 25mA, DC500V 50MΩ min (At Room Temperature)					
ENVIRONMENT	OPERATING TEMP., HUMID. AND ALTITUDE	-10 to +70°C, 20 - 90%RH (Non condensing), 3,000m (10,000 feet) max *3					
	STORAGE TEMP., HUMID. AND ALTITUDE	-20 to +75°C, 20 - 90%RH (Non condensing), 9,000m (30,000 feet) max					
	VIBRATION	10 - 55Hz, 19.6m/s ² (2G), 3minutes period, 60minutes each along X, Y and Z axis					
	IMPACT	196.1m/s ² (20G), 11ms, once each X, Y and Z axis					
SAFETY AND NOISE REGULATIONS	AGENCY APPROVALS	UL60601-1, C-UL (CSA-C22.2 No.601.1), EN60601-1					
	CONDUCTED NOISE	Complies with FCC-B, VCCI-B, CISPR11-B, CISPR22-B, EN55011-B, EN55022-B					
	HARMONIC ATTENUATOR	Complies with IEC61000-3-2 (Class A) *6 (Not built-in to active filter *4)					
OTHERS	CASE SIZE/WEIGHT	31 X 78 X 103mm [1.22 X 3.07 X 4.06 inches] (W X H X D) / 230g max (with cover : 265g max)					
	COOLING METHOD	Convection					

*1 Measured by 20MHz oscilloscope or Ripple-Noise meter (equivalent to KEISOKU-GIKEN: RM101).
*2 Drift is the change in DC output for an eight hour period after a half-hour warm-up at 25°C.
*3 Refer to "Derating".
*4 When two or more units are used, they may not comply with the harmonic attenuator. Please contact us for details.

*5 Please contact us about safety approvals for the model with option.
*6 Please contact us about another class.
* Parallel operation with other model is not possible.
* Derating is required when operated with cover.
* A sound may occur from power supply at peak loading.

Block diagram

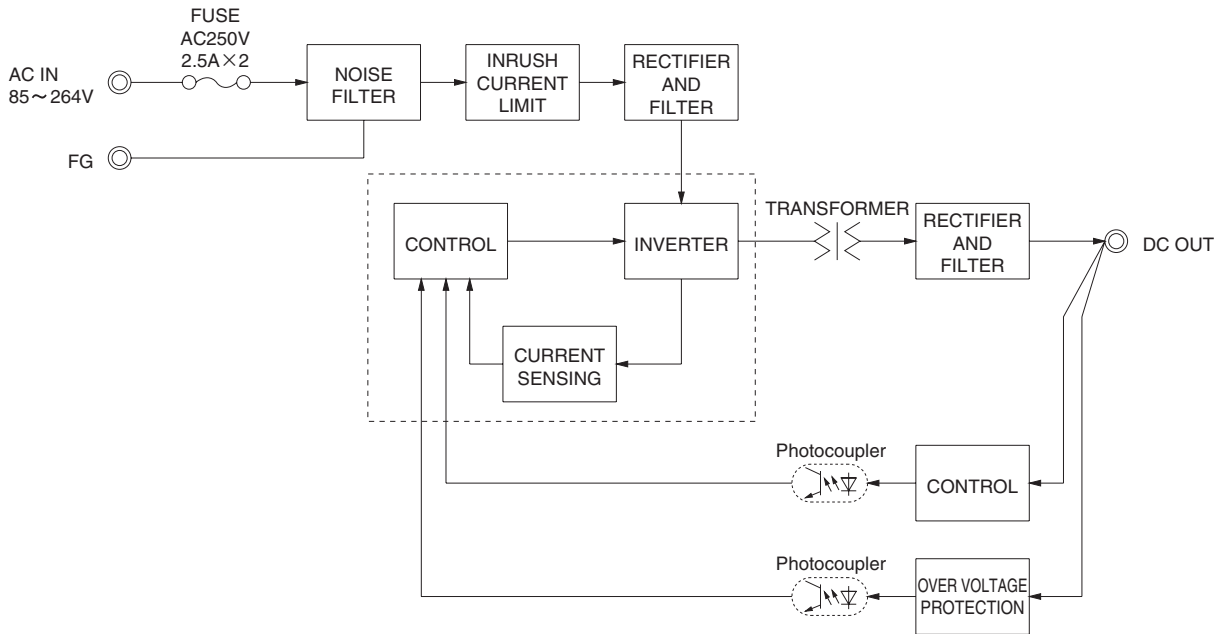

External view

※ External size of option T and T1 is different from standard model and refer to 5 Option of instruction manual for details.

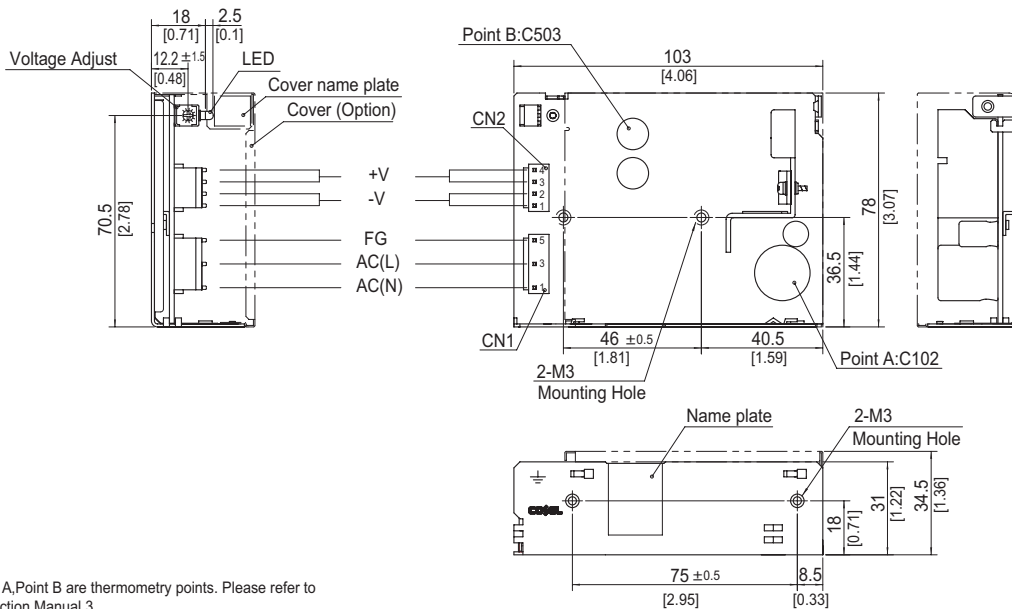

※ Point A, Point B are thermometry points. Please refer to Instruction Manual 3.

I/O Connector	Mating Connector	Terminal
CN1	1-1123722-5	Chain 1123721-1
		Loose 1318912-1
CN2	1-1123722-4	Chain 1123721-1
		Loose 1318912-1

(Mfr : Tyco Electronics AMP)

※ I/O Connector is Mfr. Tyco Electronics AMP
 ※ Option : -J1 : (J.S.T) connector type
 -T : Vertical terminal block type
 -T1 : Horizontal terminal block type
 Refer to Instruction Manual 5.

<PIN CONNECTION>

Pin No.	Input	Pin No.	Output
1	AC(N)	1, 2	-V
2		3, 4	+V
3	AC(L)		
4			
5	FG		

※ Tolerance : ±1 [±0.04]
 ※ Weight : 230g max (with cover : 265g max)
 ※ PCB Material/thickness : CEM-3 / 1.6mm [0.06inches]
 ※ Chassis material : Hot-dip galvanized steel plate
 ※ Keep drawing current per pin below 5A of CN2.
 ※ Dimensions in mm, []=inches
 ※ Mounting torque : 0.6N · m (6.3kgf · cm) max
 ※ Please connect safety ground to the unit in 2-M3 holes.

PMA30F

① PM ② A ③ 30 ④ F ⑤ -□ ⑥ -□



RoHS

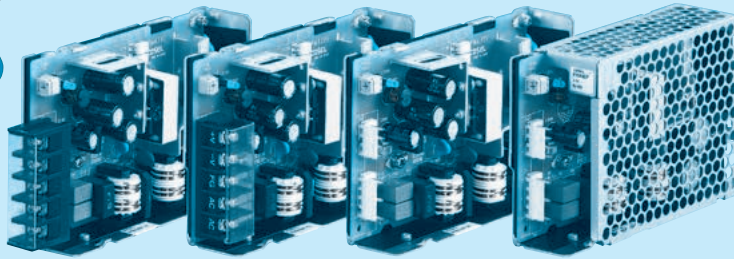

Horizontal terminal block (option : -T1) Vertical terminal block (option : -T) Standard type with Cover (option : -N)

Example recommended EMI/EMC filter
NAM-04-000



Low leakage current type : NAM series
* A higher current rating EMI/EMC filter may be recommended in view of the other devices that could be connected in parallel with the power supply.

- ① Series name
- ② Single output
- ③ Output wattage
- ④ Universal input
- ⑤ Output voltage
- ⑥ Optional *5
- T : Vertical terminal block
- T1 : Horizontal terminal block
- N : with Cover
- J1 : VH(J.S.T.)connector type

Specification is changed at option, refer to Instruction Manual.

*Make sure necessary tests will be carried out on your end equipment with the power supply installed in accordance with any required EMC/EMI regulations.

MODEL	PMA30F-3R3	PMA30F-5	PMA30F-12	PMA30F-15	PMA30F-24
MAX OUTPUT WATTAGE[W]	19.8	30	30	30	31.2
DC OUTPUT	3.3V 6A	5V 6A	12V 2.5A	15V 2A	24V 1.3A

SPECIFICATIONS

	MODEL	PMA30F-3R3	PMA30F-5	PMA30F-12	PMA30F-15	PMA30F-24	
INPUT	VOLTAGE[V]	AC85 - 264 1 φ (Refer to the Instruction Manual 1.1 and "Derating") *3					
	CURRENT[A]	ACIN 100V	0.50typ (Io=100%)	0.70typ (Io=100%)			
		ACIN 200V	0.30typ (Io=100%)	0.40typ (Io=100%)			
	FREQUENCY[Hz]	50 / 60 (47 - 440)					
	EFFICIENCY[%]	ACIN 100V	67typ	71typ	76typ	77typ	
		ACIN 200V	69typ	74typ	78typ	80typ	
INRUSH CURRENT[A]	ACIN 100V	15typ (Io=100%) (At cold start)					
	ACIN 200V	30typ (Io=100%) (At cold start)					
LEAKAGE CURRENT[mA]	0.05 / 0.10max (ACIN 100V / 240V 60Hz, Io=100%, According to IEC60601-1)						
OUTPUT	VOLTAGE[V]	3.3	5	12	15	24	
	CURRENT[A]	6.0	6.0	2.5	2.0	1.3	
	LINE REGULATION[mV]	20max	20max	48max	60max	96max	
	LOAD REGULATION[mV]	40max	40max	100max	120max	150max	
	RIPPLE[mVp-p]	*1	0 to +50°C	80max	80max	120max	120max
			-10 - 0°C	140max	140max	160max	160max
	RIPPLE NOISE[mVp-p]	*1	0 to +50°C	120max	120max	150max	150max
			-10 - 0°C	160max	160max	180max	180max
	TEMPERATURE REGULATION[mV]	*1	0 to +50°C	50max	50max	120max	240max
			-10 to +50°C	60max	60max	150max	180max
DRIFT[mV]	*2	20max	20max	48max	60max	96max	
START-UP TIME[ms]	200typ (ACIN 100V, Io=100%) *Start-up time is 700ms typ for less than 1minute of applying input again from turning off the input voltage.						
HOLD-UP TIME[ms]	20typ (ACIN 100V, Io=100%)						
OUTPUT VOLTAGE ADJUSTMENT RANGE[V]	2.85 to 3.60		4.50 to 5.50	10.00 to 13.20	13.20 to 18.00	19.20 to 27.00	
OUTPUT VOLTAGE SETTING[V]	3.30 to 3.40		5.00 to 5.15	12.00 to 12.48	15.00 to 15.60	24.00 to 24.96	
PROTECTION CIRCUIT AND OTHERS	OVERCURRENT PROTECTION	Works over 105% of rating and recovers automatically					
	OVERVOLTAGE PROTECTION[V]	4.00 to 5.25	5.75 to 7.00	15.00 to 18.00	20.00 to 25.00	30.00 to 37.00	
	OPERATING INDICATION	LED (Green)					
	REMOTE ON/OFF	Not provided					
ISOLATION	INPUT-OUTPUT	AC4,000V 1minute, Cutoff current = 10mA, DC500V 50MΩ min (At Room Temperature)					
	INPUT-FG	AC2,000V 1minute, Cutoff current = 10mA, DC500V 50MΩ min (At Room Temperature)					
	OUTPUT-FG	AC500V 1minute, Cutoff current = 25mA, DC500V 50MΩ min (At Room Temperature)					
ENVIRONMENT	OPERATING TEMP., HUMID. AND ALTITUDE	-10 to +70°C, 20 - 90%RH (Non condensing), 3,000m (10,000feet) max *3					
	STORAGE TEMP., HUMID. AND ALTITUDE	-20 to +75°C, 20 - 90%RH (Non condensing), 9,000m (30,000feet) max					
	VIBRATION	10 - 55Hz, 19.6m/s ² (2G), 3minutes period, 60minutes each along X, Y and Z axis					
	IMPACT	196.1m/s ² (20G), 11ms, once each X, Y and Z axis					
SAFETY AND NOISE REGULATIONS	AGENCY APPROVALS	UL60601-1, C-UL (CSA-C22.2 No.601.1), EN60601-1					
	CONDUCTED NOISE	Complies with FCC-B, VCCI-B, CISPR11-B, CISPR22-B, EN55011-B, EN55022-B					
	HARMONIC ATTENUATOR	Complies with IEC61000-3-2 (Class A) *6 (Not built-in to active filter *4)					
OTHERS	CASE SIZE/WEIGHT	31 X 82 X 120mm [1.22 X 3.23 X 4.72 inches] (W X H X D) / 240g max (with cover : 280g max)					
	COOLING METHOD	Convection					

*1 Measured by 20MHz oscilloscope or Ripple-Noise meter (equivalent to KEISOKU-GIKEN: RM101).
*2 Drift is the change in DC output for an eight hour period after a half-hour warm-up at 25°C.
*3 Refer to "Derating".
*4 When two or more units are used, they may not comply with the harmonic attenuator. Please contact us for details.

*5 Please contact us about safety approvals for the model with option.
*6 Please contact us about another class.
* Parallel operation with other model is not possible.
* Derating is required when operated with cover.
* A sound may occur from power supply at peak loading.

Block diagram

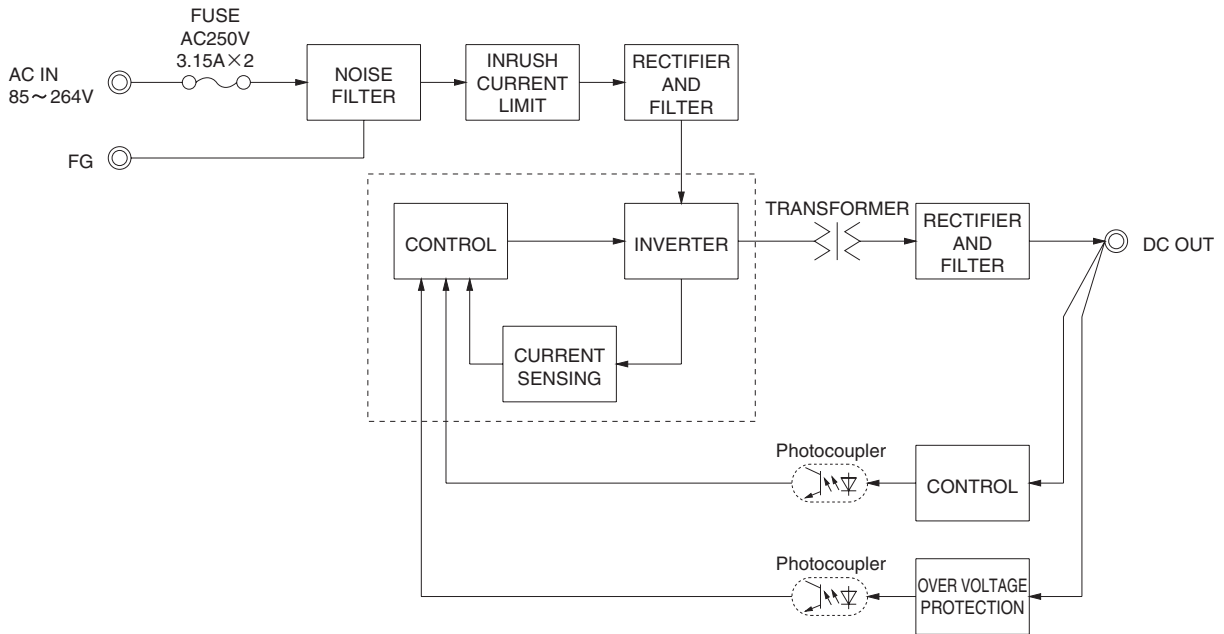

External view

※ External size of option T and T1 is different from standard model and refer to 5 Option of instruction manual for details.

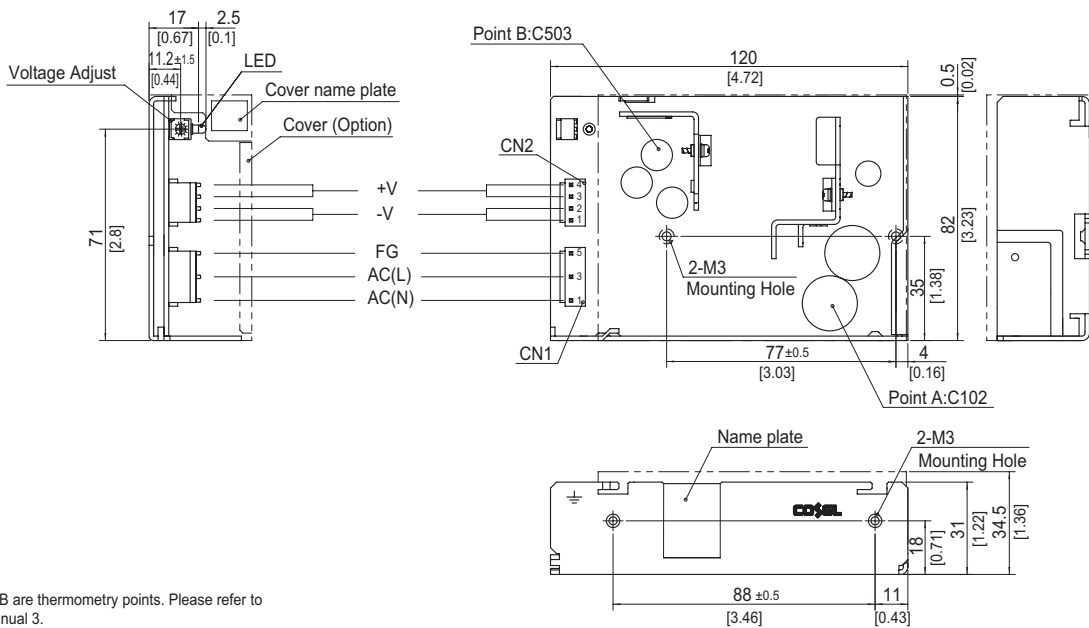

※ Point A, Point B are thermometry points. Please refer to Instruction Manual 3.

I/O Connector	Mating Connector	Terminal
CN1	1-1123724-3	Chain 1123721-1
		Loose 1318912-1
CN2	1-1123723-4	Chain 1123721-1
		Loose 1318912-1

(Mfr: Tyco Electronics AMP)

※ I/O Connector is Mfr. Tyco Electronics AMP
 ※ Option : -J1 : (J.S.T) connector type
 -T : Vertical terminal block type
 -T1 : Horizontal terminal block type
 Refer to Instruction Manual 5.

<PIN CONNECTION>

CN1		CN2	
Pin No.	Input	Pin No.	Output
1	AC(N)	1, 2	-V
2		3, 4	+V
3	AC(L)		
4			
5	FG		

※ Tolerance : ±1 [±0.04]
 ※ Weight : 240g max (with cover : 280g max)
 ※ PCB Material/thickness : CEM-3 / 1.6mm [0.06inches]
 ※ Chassis material : Aluminum
 ※ Keep drawing current per pin below 5A of CN2.
 ※ Dimensions in mm, []=inches
 ※ Mounting torque : 0.49N · m (5kgf · cm) max
 ※ Please connect safety ground to the unit in 2-M3 holes.

PMA60F

① PM ② A ③ 60 ④ F ⑤ -□ ⑥ -□

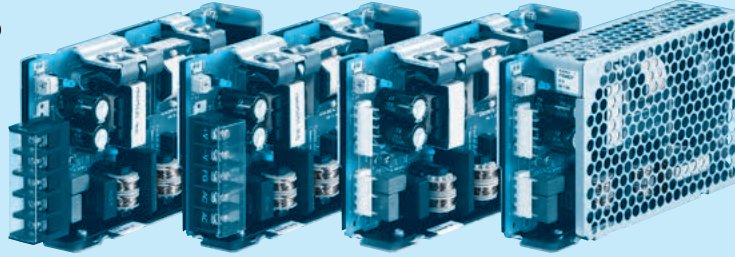
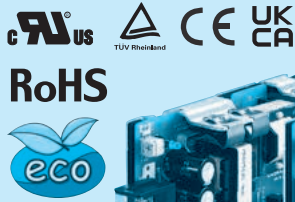

Horizontal terminal block (option : -T1) Vertical terminal block (option : -T) Standard type with Cover (option : -N)

Example recommended EMI/EMC filter
NAM-04-000



Low leakage current type : NAM series
* A higher current rating EMI/EMC filter may be recommended in view of the other devices that could be connected in parallel with the power supply.

- ① Series name
- ② Single output
- ③ Output wattage
- ④ Universal input
- ⑤ Output voltage
- ⑥ Optional *5
- T : Vertical terminal block
- T1 : Horizontal terminal block
- N : with Cover
- J1 : VH(J.S.T.)connector type
- R : with Remote ON/OFF

Specification is changed at option, refer to Instruction Manual.

*Make sure necessary tests will be carried out on your end equipment with the power supply installed in accordance with any required EMC/EMI regulations.

MODEL	PMA60F-3R3	PMA60F-5	PMA60F-12	PMA60F-15	PMA60F-24
MAX OUTPUT WATTAGE[W]	39.6	60	60	60	60
DC OUTPUT	3.3V 12A	5V 12A	12V 5A	15V 4A	24V 2.5A

SPECIFICATIONS

	MODEL	PMA60F-3R3	PMA60F-5	PMA60F-12	PMA60F-15	PMA60F-24	
INPUT	VOLTAGE[V]	AC85 - 264 1 φ (Refer to the Instruction Manual 1.1)					
	CURRENT[A]	ACIN 100V	0.7typ (Io=100%)	0.8typ (Io=100%)			
		ACIN 200V	0.4typ (Io=100%)	0.5typ (Io=100%)			
	FREQUENCY[Hz]	50 / 60 (47 - 63)					
	EFFICIENCY[%]	ACIN 100V	77typ	80typ	80typ	81typ	81typ
		ACIN 200V	78typ	83typ	82typ	83typ	83typ
	POWER FACTOR (Io=100%)	ACIN 100V	0.98typ				
		ACIN 200V	0.85typ		0.90typ		
INRUSH CURRENT[A]	ACIN 100V	15typ (Io=100%) (At cold start)					
	ACIN 200V	30typ (Io=100%) (At cold start)					
LEAKAGE CURRENT[ma]	0.09 / 0.18max (ACIN 100V / 240V 60Hz, Io=100%, According to IEC60601-1)						
OUTPUT	VOLTAGE[V]	3.3	5	12	15	24	
	CURRENT[A]	12.0	12.0	5.0	4.0	2.5	
	LINE REGULATION[mV]	20max					
	LOAD REGULATION[mV]	40max					
	RIPPLE[mVp-p]	0 to +50°C	80max	80max	120max	120max	120max
		-10 - 0°C	140max	140max	160max	160max	160max
	RIPPLE NOISE[mVp-p]	0 to +50°C	120max	120max	150max	150max	150max
		-10 - 0°C	160max	160max	180max	180max	180max
	TEMPERATURE REGULATION[mV]	0 to +50°C	50max	50max	120max	150max	240max
		-10 to +50°C	60max	60max	150max	180max	290max
	DRIFT[mV]	*2	20max	20max	48max	60max	96max
	START-UP TIME[ms]	250typ (ACIN 100V, Io=100%)					
HOLD-UP TIME[ms]	20typ (ACIN 100V, Io=100%)						
OUTPUT VOLTAGE ADJUSTMENT RANGE[V]	2.85 to 3.60	4.50 to 5.50	10.00 to 13.20	13.20 to 18.00	19.20 to 27.00		
OUTPUT VOLTAGE SETTING[V]	3.30 to 3.40	5.00 to 5.15	12.00 to 12.48	15.00 to 15.60	24.00 to 24.96		
PROTECTION CIRCUIT AND OTHERS	OVERCURRENT PROTECTION	Works over 105% of rating and recovers automatically					
	OVERVOLTAGE PROTECTION[V]	4.00 to 5.25	5.75 to 7.00	15.00 to 18.00	20.00 to 25.00	30.00 to 37.00	
	OPERATING INDICATION	LED (Green)					
	REMOTE ON/OFF	Optional (Required external power source)					
ISOLATION	INPUT-OUTPUT-RC	*3 AC4,000V 1minute, Cutoff current = 10mA, DC500V 50MΩ min (At Room Temperature)					
	INPUT-FG	AC2,000V 1minute, Cutoff current = 10mA, DC500V 50MΩ min (At Room Temperature)					
	OUTPUT-RC-FG	*3 AC500V 1minute, Cutoff current = 25mA, DC500V 50MΩ min (At Room Temperature)					
ENVIRONMENT	OPERATING TEMP.,HUMID.AND ALTIITUDE	-10 to +70°C, 20 - 90%RH (Non condensing), 3,000m (10,000feet) max *4					
	STORAGE TEMP.,HUMID.AND ALTIITUDE	-20 to +75°C, 20 - 90%RH (Non condensing), 9,000m (30,000feet) max					
	VIBRATION	10 - 55Hz, 19.6m/s ² (2G), 3minutes period, 60minutes each along X, Y and Z axis					
	IMPACT	196.1m/s ² (20G), 11ms, once each X, Y and Z axis					
SAFETY AND NOISE REGULATIONS	AGENCY APPROVALS	UL60601-1, C-UL (CSA-C22.2 No.601.1), EN60601-1					
	CONDUCTED NOISE	Complies with FCC-B, VCCI-B, CISPR11-B, CISPR22-B, EN55011-B, EN55022-B					
	HARMONIC ATTENUATOR	Complies with IEC61000-3-2 *6					
OTHERS	CASE SIZE/WEIGHT	32 X 82 X 135mm [1.26 X 3.23 X 5.31 inches] (W X H X D) / 350g max (with cover : 395g max)					
	COOLING METHOD	Convection					

*1 Measured by 20MHz oscilloscope or Ripple-Noise meter (equivalent to KEISOKU-GIKEN: RM101).
 *2 Drift is the change in DC output for an eight hour period after a half-hour warm-up at 25°C.
 *3 Applicable when Remote ON/OFF (optional) is added. RC is insulated with input, output and FG.
 *4 Refer to "Derating".
 *5 Please contact us about safety approvals for the model with option.

*6 Please contact us about class C.
 * Parallel operation with other model is not possible.
 * Derating is required when operated with cover.
 * A sound may occur from power supply at peak loading.

Block diagram

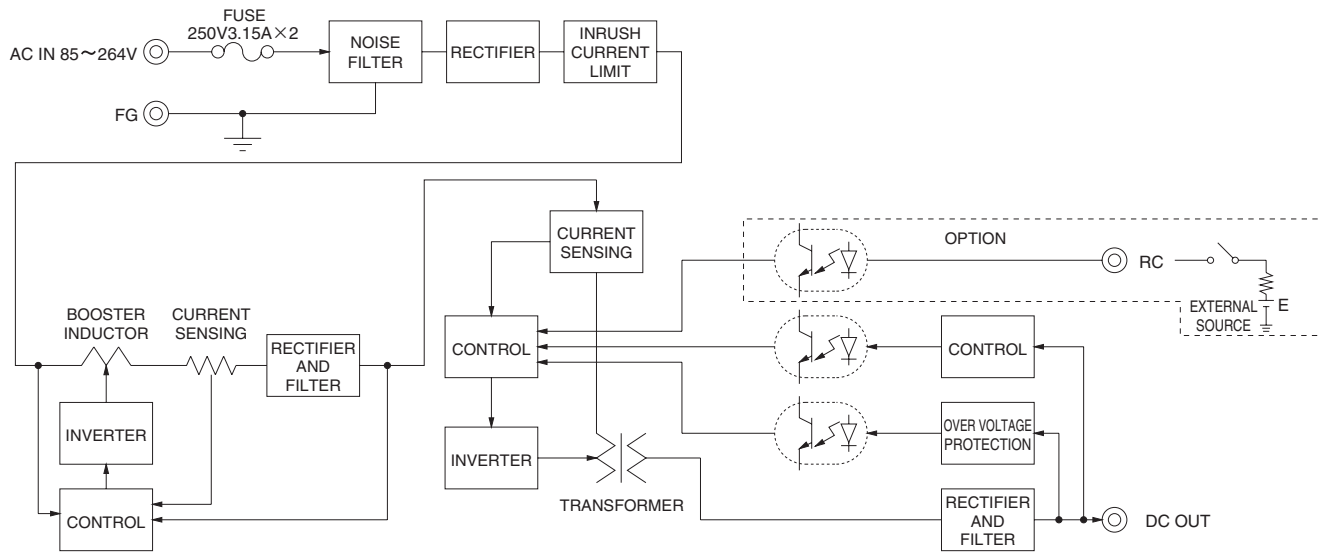

External view

※ External size of option T and T1 is different from standard model and refer to 5 Option of instruction manual for details.

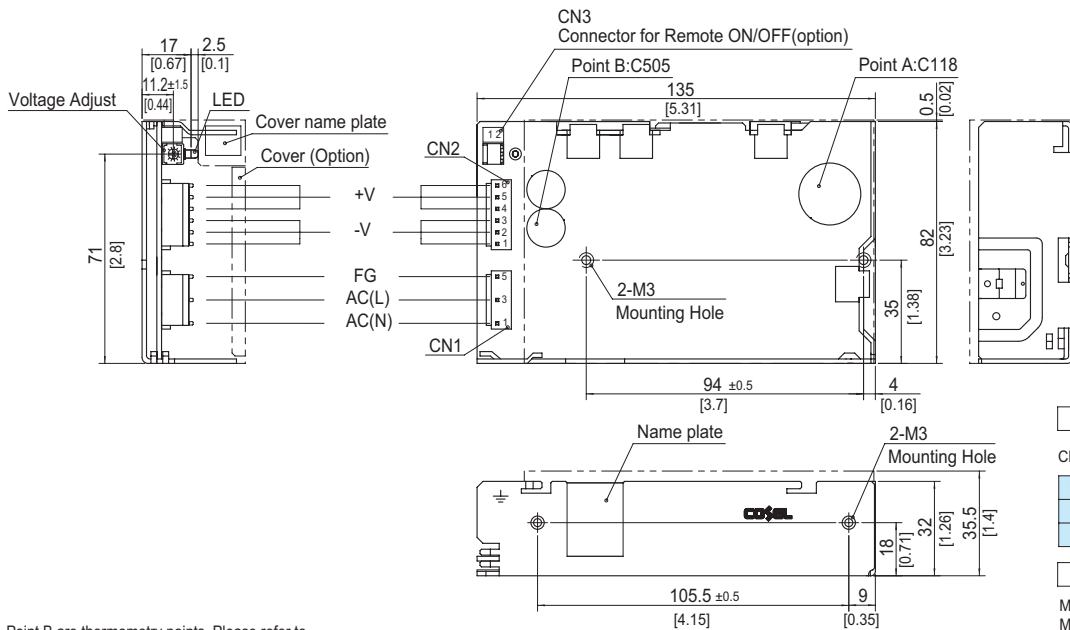

※ Point A, Point B are thermometry points. Please refer to Instruction Manual 3.

I/O Connector	Mating Connector	Terminal
CN1	1-1123724-3	1-1123722-5 Chain 1123721-1
		Loose 1318912-1
CN2	1-1123723-6	1-1123722-6 Chain 1123721-1
		Loose 1318912-1

(Mfr : Tyco Electronics AMP)

※ I/O Connector is Mfr. Tyco Electronics AMP
 ※ Option : -J1 : (J.S.T) connector type
 -T : Vertical terminal block type
 -T1 : Horizontal terminal block type
 Refer to Instruction Manual 5.

<PIN CONNECTION>

Pin No.	Input
1	AC(N)
2	
3	AC(L)
4	
5	FG

Pin No.	Output
1 - 3	-V
4 - 6	+V

※ Tolerance : ±1 [±0.04]
 ※ Weight : 350g max (with cover : 395g max)
 ※ PCB Material/thickness : CEM-3 / 1.6mm [0.06inches]
 ※ Chassis material : Aluminum
 ※ Keep drawing current per pin below 5A of CN2.
 ※ Dimensions in mm, []=inches
 ※ Mounting torque : 0.49N · m (5kgf · cm) max
 ※ Please connect safety ground to the unit in 2-M3 holes.

Connector type

CN3 Option (Mfr. J.S.T)

PIN No.	Contents
1	RC(+)
2	RC(-)

Barrier strip type

Model B2B-XH-A
 Mating Connector (Terminal)
 XHP-2
 (BXH-001T-P0.6
 or SXH-001T-P0.6)

PMA100F

① PM ② A ③ 100 ④ F ⑤ -□ ⑥ -□

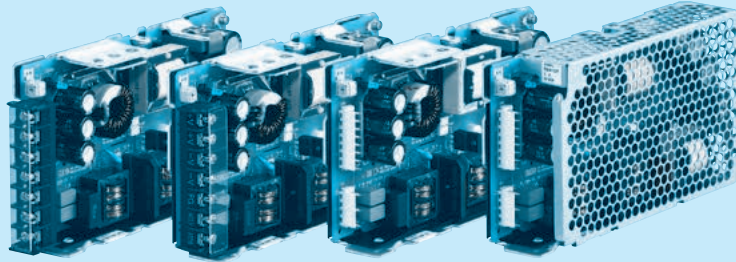
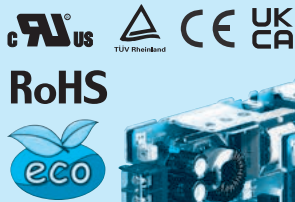

Horizontal terminal block (option : -T1) Vertical terminal block (option : -T) Standard type with Cover (option : -N)

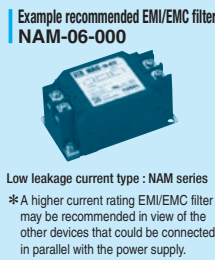

- ① Series name
- ② Single output
- ③ Output wattage
- ④ Universal input
- ⑤ Output voltage
- ⑥ Optional *5
- T : Vertical terminal block
- T1 : Horizontal terminal block
- N : with Cover
- J1 : VH(J.S.T.)connector type
- R : with Remote ON/OFF

Low leakage current type : NAM series
*A higher current rating EMI/EMC filter may be recommended in view of the other devices that could be connected in parallel with the power supply.

Specification is changed at option, refer to Instruction Manual.

*Make sure necessary tests will be carried out on your end equipment with the power supply installed in accordance with any required EMC/EMI regulations.

MODEL	PMA100F-3R3	PMA100F-5	PMA100F-12	PMA100F-24	PMA100F-48
MAX OUTPUT WATTAGE[W]	66	100	102	108	100.8
DC OUTPUT	3.3V 20A	5V 20A	12V 8.5A	24V 4.5A	48V 2.1A

SPECIFICATIONS

	MODEL	PMA100F-3R3	PMA100F-5	PMA100F-12	PMA100F-24	PMA100F-48	
INPUT	VOLTAGE[V]	AC85 - 264 1 φ (Refer to the Instruction Manual 1.1)					
	CURRENT[A]	ACIN 100V	0.9typ (Io=100%)	1.3typ (Io=100%)			
		ACIN 200V	0.5typ (Io=100%)	0.7typ (Io=100%)			
	FREQUENCY[Hz]	50 / 60 (47 - 63)					
	EFFICIENCY[%]	ACIN 100V	77typ	81typ	82typ	84typ	84typ
		ACIN 200V	78typ	83typ	83typ	86typ	86typ
	POWER FACTOR (Io=100%)	ACIN 100V	0.98typ				
		ACIN 200V	0.85typ	0.90typ			
INRUSH CURRENT[A]	ACIN 100V	20typ (Io=100%) (At cold start)					
	ACIN 200V	40typ (Io=100%) (At cold start)					
LEAKAGE CURRENT[mA]	0.09 / 0.18max (ACIN 100V / 240V 60Hz, Io=100%, According to IEC60601-1)						
OUTPUT	VOLTAGE[V]	3.3	5	12	24	48	
	CURRENT[A]	20.0	20.0	8.5	4.5	2.1	
	LINE REGULATION[mV]	20max	20max	48max	96max	192max	
	LOAD REGULATION[mV]	40max	40max	100max	150max	240max	
	RIPPLE[mVp-p]	0 to +50°C	80max	80max	120max	150max	150max
		*1 -10 -0°C	140max	140max	160max	160max	200max
	RIPPLE NOISE[mVp-p]	0 to +50°C	120max	120max	150max	150max	250max
		*1 -10 -0°C	160max	160max	180max	180max	300max
	TEMPERATURE REGULATION[mV]	0 to +50°C	50max	50max	120max	240max	480max
		*1 -10 to +50°C	60max	60max	150max	290max	600max
	DRIFT[mV]	*2	20max	20max	48max	96max	192max
	START-UP TIME[ms]	250typ (ACIN 100V, Io=100%)					
	HOLD-UP TIME[ms]	20typ (ACIN 100V, Io=100%)					
OUTPUT VOLTAGE ADJUSTMENT RANGE[V]	2.85 to 3.60	4.50 to 5.50	10.00 to 13.20	19.20 to 27.00	39.00 to 53.00		
OUTPUT VOLTAGE SETTING[V]	3.30 to 3.40	5.00 to 5.15	12.00 to 12.48	24.00 to 24.96	48.00 to 49.92		
PROTECTION CIRCUIT AND OTHERS	OVERCURRENT PROTECTION	Works over 105% of rating and recovers automatically					
	OVERVOLTAGE PROTECTION[V]	4.00 to 5.25	5.75 to 7.00	15.00 to 18.00	30.00 to 37.00	58.00 to 65.00	
	OPERATING INDICATION	LED (Green)					
	REMOTE ON/OFF	Optional (Required external power source)					
ISOLATION	INPUT-OUTPUT-RC	*3 AC4,000V 1minute, Cutoff current = 10mA, DC500V 50MΩ min (At Room Temperature)					
	INPUT-FG	AC2,000V 1minute, Cutoff current = 10mA, DC500V 50MΩ min (At Room Temperature)					
	OUTPUT-RC-FG	*3 AC500V 1minute, Cutoff current = 25mA, DC500V 50MΩ min (At Room Temperature)					
ENVIRONMENT	OPERATING TEMP.,HUMID.AND ALTITUDE	-10 to +70°C, 20 - 90%RH (Non condensing), 3,000m (10,000feet) max *4					
	STORAGE TEMP.,HUMID.AND ALTITUDE	-20 to +75°C, 20 - 90%RH (Non condensing), 9,000m (30,000feet) max					
	VIBRATION	10 - 55Hz, 19.6m/s ² (2G), 3minutes period, 60minutes each along X, Y and Z axis					
	IMPACT	196.1m/s ² (20G), 11ms, once each X, Y and Z axis					
SAFETY AND NOISE REGULATIONS	AGENCY APPROVALS	UL60601-1, C-UL (CSA-C22.2 No.601.1), EN60601-1					
	CONDUCTED NOISE	Complies with FCC-B, VCCI-B, CISPR11-B, CISPR22-B, EN55011-B, EN55022-B					
	HARMONIC ATTENUATOR	Complies with IEC61000-3-2 *6					
OTHERS	CASE SIZE/WEIGHT	34 X 93 X 168mm [1.34 X 3.66 X 6.61 inches] (W X H X D) / 560g max (with cover : 625g max)					
	COOLING METHOD	Convection					

*1 Measured by 20MHz oscilloscope or Ripple-Noise meter (equivalent to KEISOKU-GIKEN: RM101).
*2 Drift is the change in DC output for an eight hour period after a half-hour warm-up at 25°C.
*3 Applicable when Remote ON/OFF (optional) is added. RC is insulated with input, output and FG.
*4 Refer to "Derating".
*5 Please contact us about safety approvals for the model with option.

*6 Please contact us about class C.
* Parallel operation with other model is not possible.
* Derating is required when operated with cover.
* A sound may occur from power supply at peak loading.

Block diagram

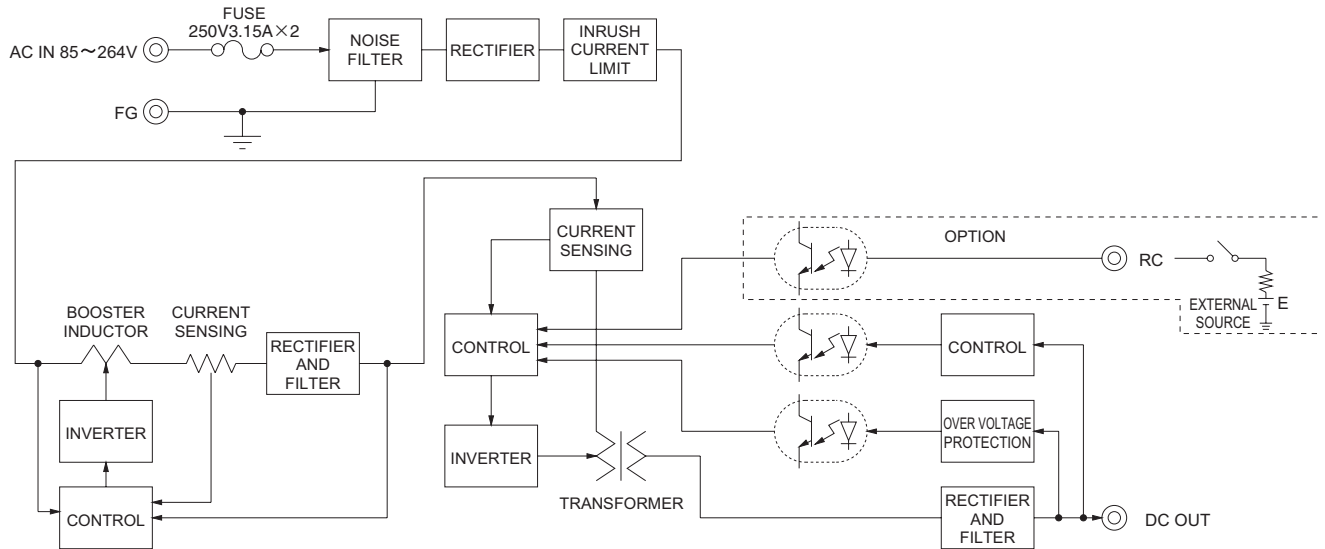

External view

※ External size of option T and T1 is different from standard model and refer to 5 Option of instruction manual for details.

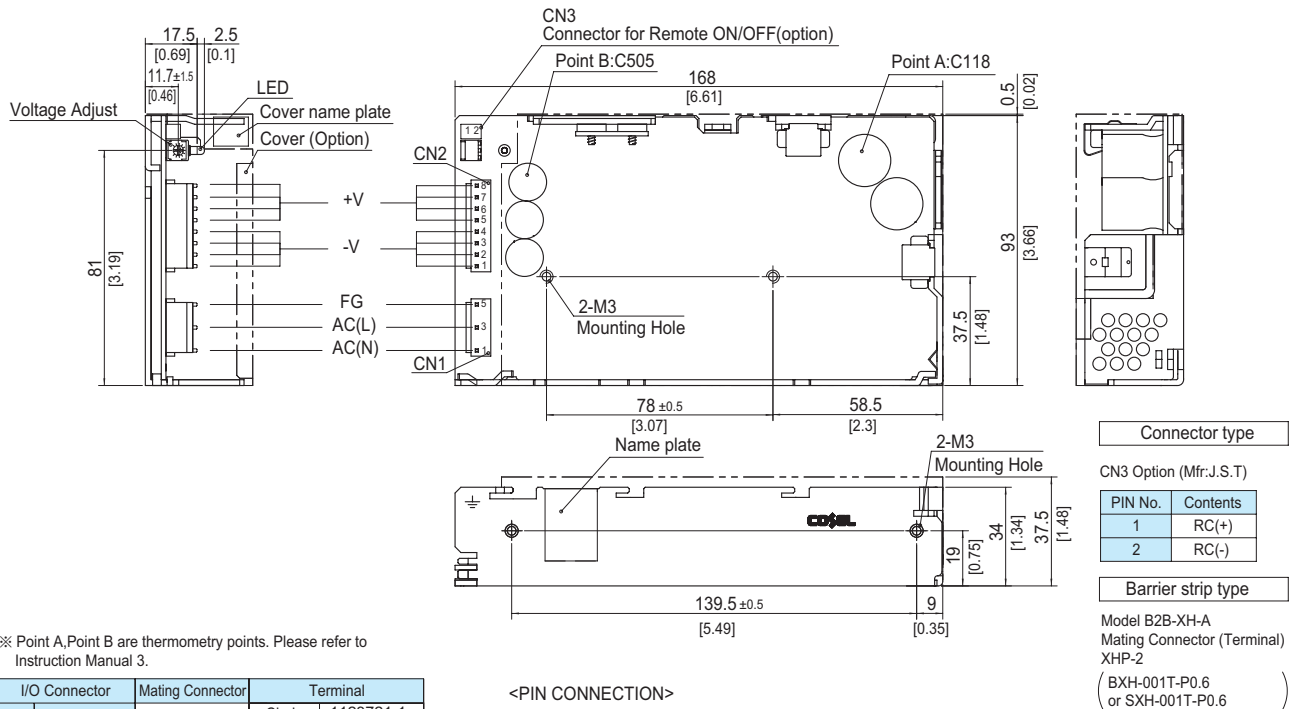

※ Point A, Point B are thermometry points. Please refer to Instruction Manual 3.

I/O Connector	Mating Connector	Terminal
CN1	1-1123724-3	1-1123722-5
		Chain 1123721-1
		Loose 1318912-1
CN2	1-1123723-8	1-1123722-8
		Chain 1123721-1
		Loose 1318912-1

(Mfr: Tyco Electronics AMP)

※ I/O Connector is Mfr. Tyco Electronics AMP
 ※ Option: -J1 : (J.S.T) connector type
 -T : Vertical terminal block type
 -T1 : Horizontal terminal block type
 Refer to Instruction Manual 5.

※ Tolerance : ± 1 [± 0.04]
 ※ Weight : 560g max (with cover : 625g max)
 ※ PCB Material/thickness : CEM-3 / 1.6mm [0.06inches]
 ※ Chassis material : Aluminum
 ※ Keep drawing current per pin below 5A of CN2.
 ※ Dimensions in mm, [] =inches
 ※ Mounting torque : 0.49N · m (5kgf · cm) max
 ※ Please connect safety ground to the unit in 2-M3 holes.

Assembling and Installation Method

Installation method

■ Do not insert a screw more than 6mm from the outside of a power supply to keep enough insulation distance between the screw and internal components.

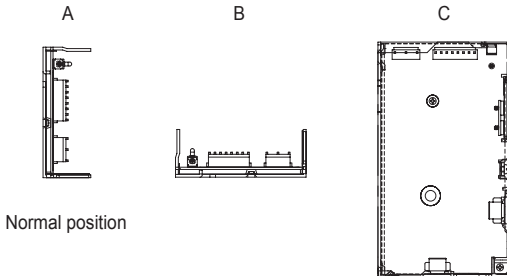

Normal position

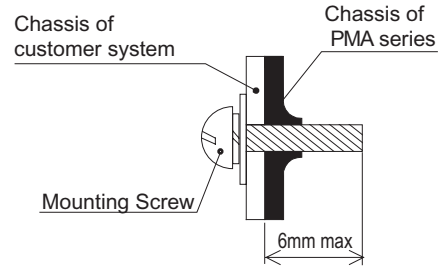

- If you use two or more power supplies side by side, please keep a sufficient distance between them to allow enough air ventilation.
- Ambient temperature around each power supply should not exceed the temperature range shown in “Derating”.

Derating

● PMA15F,PMA30F Input voltage Derating Curve

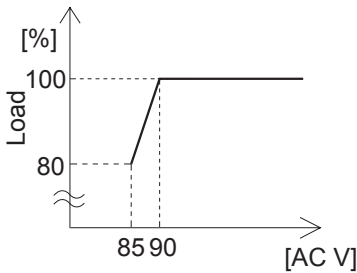

● Ambient temperature Derating Curve (Reference value)

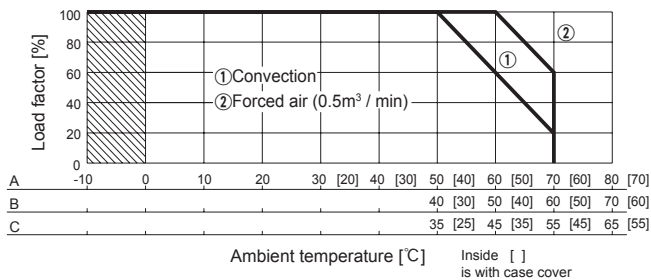

- In the hatched area, the specification of Ripple, Ripple Noise is different from other area.
- The ambient temperature should be measured 5 to 10 cm away from the power supply so that it won't be influenced by the heat from the power supply. Please consult us for more details.
- Make sure the temperature at point A and point B is less than the temperatures shown in Instruction Manual 3.

Instruction Manual

◆ It is necessary to read the “Instruction Manual” and “Before using our product” before you use our product.

Instruction Manual <https://www.cosel.co.jp/redirect/catalog/en/PMA/>
 Before using our product <https://en.cosel.co.jp/technical/caution/index.html>



Basic Characteristics Data

Model	Circuit method	Switching frequency [kHz]	Input current [A] *1	Inrush current protection	PCB/Pattern			Series/Parallel operation availability *2	
					Material	Single sided	Double sided	Series operation	Parallel operation
PMA15F	Flyback converter	100	0.4	Thermistor	CEM-3	Yes		Yes	No
PMA30F	Flyback converter	100	0.7	Thermistor	CEM-3	Yes		Yes	No
PMA60F	Active filter	60 - 550	0.8	Thermistor	CEM-3	Yes		Yes	No
	Forward converter	120							
PMA100F	Active filter	60 - 550	1.3	Thermistor	CEM-3	Yes		Yes	No
	Forward converter	120							

*1 The value of input current is at ACIN 100V and rated load.

*2 Refer to Instruction Manual 2.