

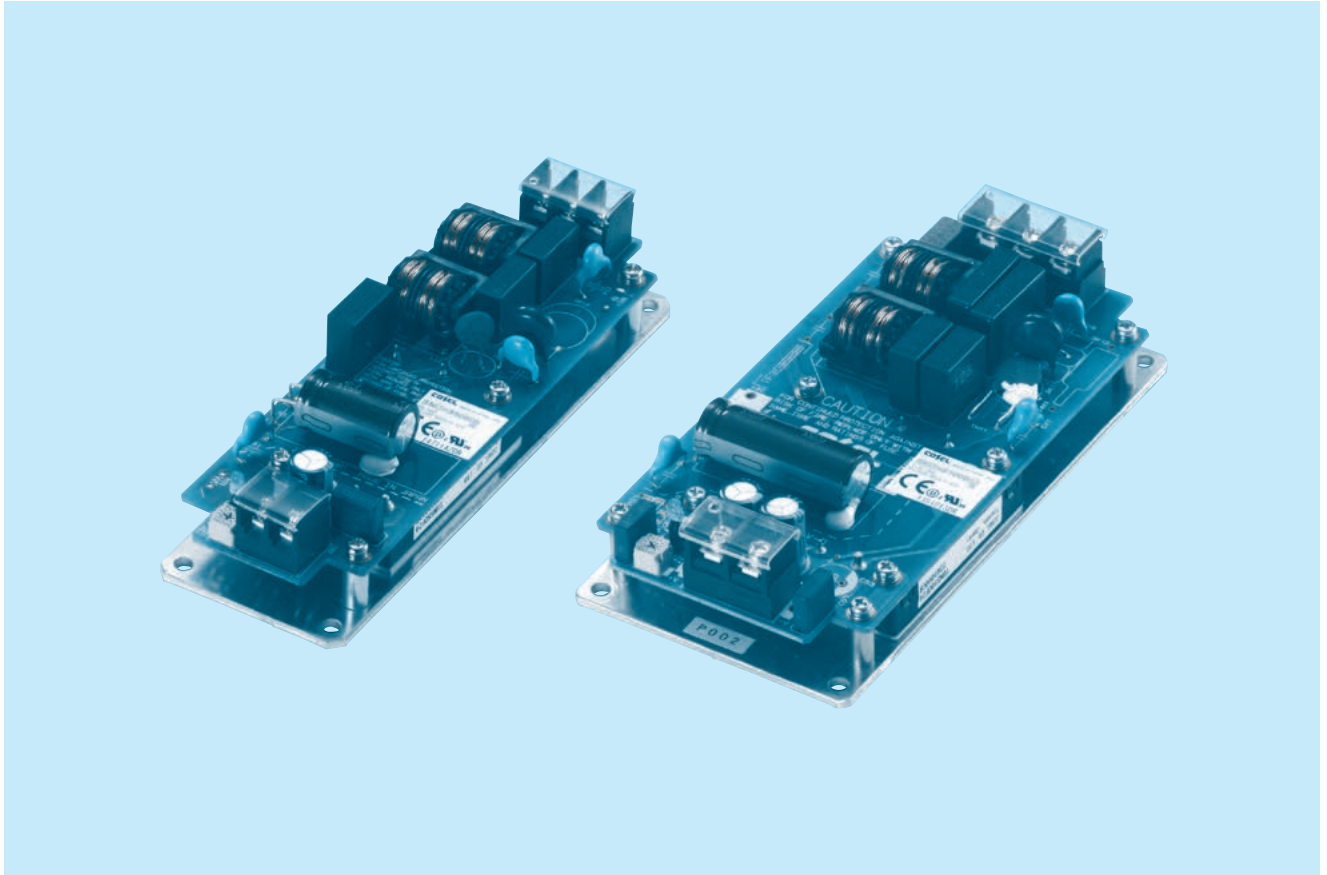

SNTU-series



■ Feature

AC-DC converter, SNTUNS50/100F series includes TUNS50/100F series.
 Universal input(AC85-264V)
 Power factor correction
 Harmonic attenuator (Complies with IEC61000-3-2)
 Built-in Inrush current , overcurrent, overvoltage and thermal protection

■ Safety agency approvals

UL60950-1, C-UL, EN62368-1
 Complies with DEN-AN

■ 3-year warranty

■ CE marking

Low voltage directive
 RoHS Directive

■ UKCA marking

Electrical Equipment Safety Regulations
 RoHS Regulations

SNTUNS50

SNTUN S 50 F 05 -□

① ② ③ ④ ⑤ ⑥

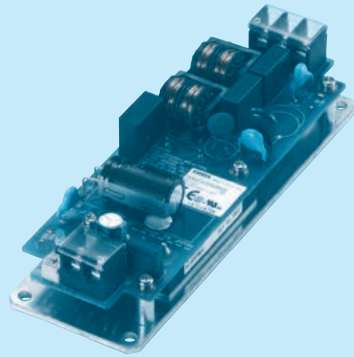

Recommended EMI/EMC Filter
NAC-04-472



High voltage pulse noise type : NAP series
Low leakage current type : NAM series
*The EMI/EMC Filter is recommended to connect with several devices.

- ① Series name
- ② Single output
- ③ Output wattage
- ④ Universal Input
- ⑤ Output voltage
- ⑥ Optional
- C :with Coating
- J :Connector type

MODEL	SNTUNS50F05	SNTUNS50F12	SNTUNS50F24
MAX OUTPUT WATTAGE[W]	50.0	50.4	50.4
DC OUTPUT	5V 10A	12V 4.2A	24V 2.1A

SPECIFICATIONS

	MODEL	SNTUNS50F05	SNTUNS50F12	SNTUNS50F24	
INPUT	VOLTAGE[V]	AC85 - 264 1 φ (Please refer to the instruction manual 1.1 and 3.2)			
	CURRENT[A]	ACIN 100V	0.67typ (Io=100%)		
		ACIN 200V	0.37typ (Io=100%)		
	FREQUENCY[Hz]	50/60 (47 - 63)			
	EFFICIENCY[%]	ACIN 100V	76typ	80typ	81typ
		ACIN 200V	78typ	83typ	84typ
	POWER FACTOR (Io=100%)	ACIN 100V	0.95typ		
		ACIN 200V	0.90typ		
INRUSH CURRENT[A]	ACIN 100V	15typ (Io=100%) (At cold start) (Ta=25°C)			
	ACIN 200V	30typ (Io=100%) (At cold start) (Ta=25°C)			
LEAKAGE CURRENT[mA]	0.4/0.75 (ACIN 100V / 240V 60Hz, Io=100%, According to IEC62368-1 and DEN-AN)				
OUTPUT	VOLTAGE[V]	5	12	24	
	CURRENT[A]	10	4.2	2.1	
	LINE REGULATION[mV]	10max	24max	48max	
	LOAD REGULATION[mV]	150max	100max	100max	
	RIPPLE[mVp-p]	0 to +95°C *1	80max	120max	120max
		-20 to 0°C *1	140max	160max	160max
		0 to 15% Load *1	200max	280max	380max
	RIPPLE NOISE[mVp-p]	0 to +95°C *1	120max	150max	150max
		-20 to 0°C *1	200max	200max	250max
		0 to 15% Load *1	280max	360max	460max
	TEMPERATURE REGULATION[mV]	0 to +65°C	50max	120max	240max
		-20 to +95°C	100max	240max	480max
	DRIFT[mV]	*2	20max	40max	90max
	OUTPUT VOLTAGE ADJUSTMENT RANGE[V]	4.50 - 5.50	10.80 - 13.20	21.60 - 26.40	
OUTPUT VOLTAGE SETTING[V]	5.00 - 5.15	12.00 - 12.48	24.00 - 24.96		
PROTECTION CIRCUIT AND OTHERS	OVERCURRENT PROTECTION	Works over 105% of rating and recovers automatically			
	OVERVOLTAGE PROTECTION[V]	6.30 - 7.00	13.90 - 16.35	27.60 - 32.40	
	REMOTE SENSING	Not provided			
	REMOTE ON/OFF	Not provided			
ISOLATION	INPUT-OUTPUT	AC3,000V 1minute, Cutoff current = 10mA, DC500V 50MΩ min (20±15°C)			
	INPUT-FG	AC2,000V 1minute, Cutoff current = 10mA, DC500V 50MΩ min (20±15°C)			
	OUTPUT-FG	AC500V 1minute, Cutoff current = 100mA, DC500V 50MΩ min (20±15°C)			
ENVIRONMENT	OPERATING TEMP., HUMID. AND ALTITUDE	-20 to +95°C (On aluminum base plate), 20 - 95%RH (Non condensing) *4			
	STORAGE TEMP., HUMID. AND ALTITUDE	-20 to +95°C, 20 - 95%RH (Non condensing), 9,000m (30,000 feet) max			
	VIBRATION	10 - 55Hz, 19.6m/s ² (2G), 3minutes period, 60minutes each along X, Y and Z axis			
	IMPACT	196.1m/s ² (20G), 11ms, once each along X, Y and Z axis			
SAFETY AND NOISE REGULATIONS	AGENCY APPROVALS	UL60950-1, C-UL (CSA60950-1), EN62368-1 Complies with DEN-AN			
	CONDUCTED NOISE	Complies with FCC-B, VCCI-B, CISPR-B, EN55011-B, EN55022-B			
	HARMONIC ATTENUATOR	Complies with IEC61000-3-2 (Class A) *3			
OTHERS	CASE SIZE/WEIGHT	50 X 36 X 150mm [1.97 X 1.42 X 5.91 inches] (W X H X D) / 230g max			

*1 Refer to Instruction manual for measuring method of an electrical property.

*2 Drift is the change in DC output for an eight hour period after a half-hour warm-up at 25°C, with the input voltage held constant at the rated input/output.

*3 Please contact us about another class.

*4 Refer to Instruction manual 3.2 and 3.3.

Block diagram

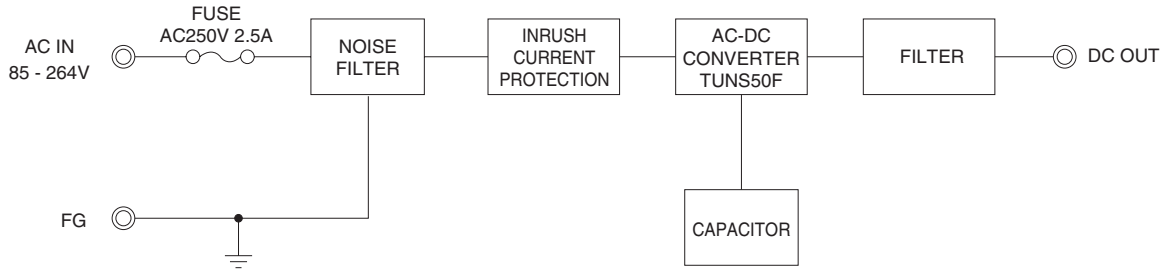

External view

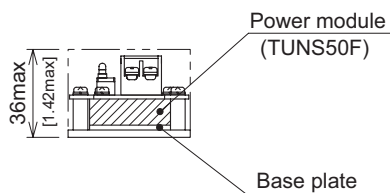
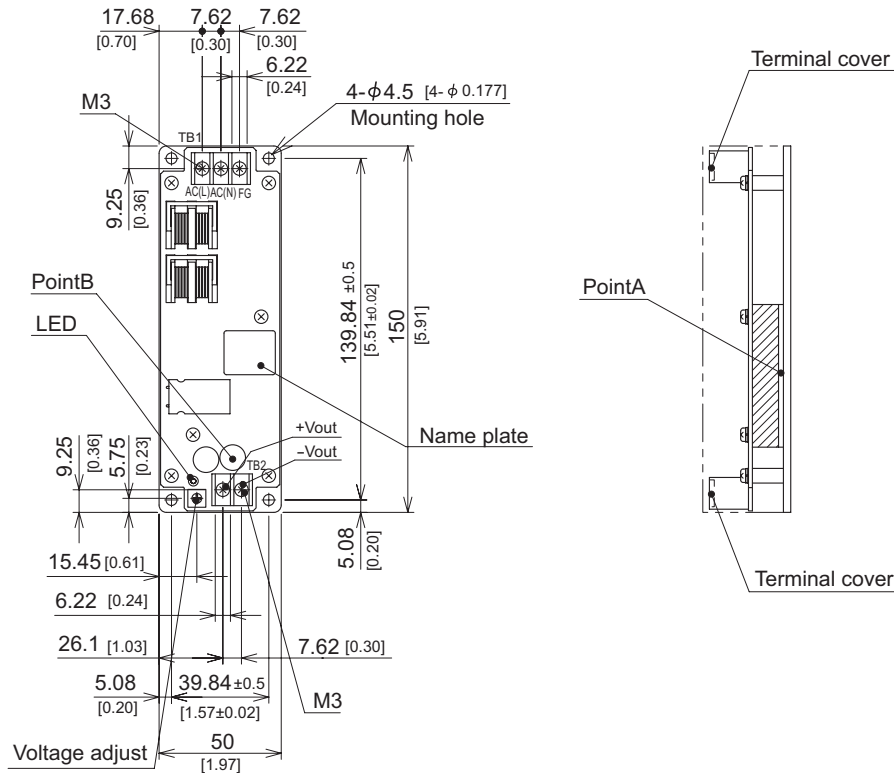

- * Tolerance ± 1 [± 0.04]
- * Weight : 230g max
- * Dimensions in mm, []=inches
- * PCB material / thickness : FR-4 / 1.6mm [0.06]
- * Base plate material / thickness : Aiuminum / 3.0mm [0.12]
- * Screw tightning torque M3 : $0.9N \cdot m$ (9.2kgf \cdot cm) max
- * Please connect safety ground to the base plate in $\phi 4.5$ [$\phi 0.177$] hole.

SNTUNS100

SNTUN S 100 F 05 -□

① ② ③ ④ ⑤ ⑥

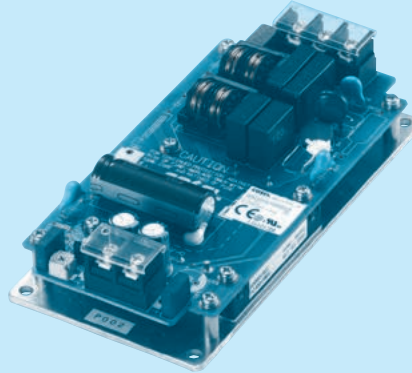

Recommended EMI/EMC Filter
NAC-04-472



High voltage pulse noise type : NAP series
Low leakage current type : NAM series

*The EMI/EMC Filter is recommended to connect with several devices.

- ① Series name
- ② Single output
- ③ Output wattage
- ④ Universal Input
- ⑤ Output voltage
- ⑥ Optional
- C :with Coating
- J :Connector type

MODEL	SNTUNS100F05	SNTUNS100F12	SNTUNS100F24
MAX OUTPUT WATTAGE[W]	100.0	100.8	100.8
DC OUTPUT	5V 20A	12V 8.4A	24V 4.2A

SPECIFICATIONS

	MODEL	SNTUNS100F05	SNTUNS100F12	SNTUNS100F24	
INPUT	VOLTAGE[V]	AC85 - 264 1 φ (Please refer to the instruction manual 1.1 and 3.2)			
	CURRENT[A]	ACIN 100V	1.3typ (Io=100%)		
		ACIN 200V	0.7typ (Io=100%)		
	FREQUENCY[Hz]	50/60 (47 - 63)			
	EFFICIENCY[%]	ACIN 100V	79typ	81typ	82typ
		ACIN 200V	82typ	83typ	84typ
	POWER FACTOR (Io=100%)	ACIN 100V	0.95typ		
		ACIN 200V	0.90typ		
INRUSH CURRENT[A]	ACIN 100V	20yp (Io=100%) (At cold start) (Ta=25°C)			
	ACIN 200V	40typ (Io=100%) (At cold start) (Ta=25°C)			
LEAKAGE CURRENT[mA]	0.4/0.75 (ACIN 100V / 240V 60Hz, Io=100%, According to IEC62368-1 and DEN-AN)				
OUTPUT	VOLTAGE[V]	5	12	24	
	CURRENT[A]	20	8.4	4.2	
	LINE REGULATION[mV]	10max	24max	48max	
	LOAD REGULATION[mV]	150max	100max	100max	
	RIPPLE[mVp-p]	0 to +95°C *1	80max	120max	120max
		-20 to 0°C *1	140max	160max	160max
		0 to 15% Load *1	160max	240max	240max
	RIPPLE NOISE[mVp-p]	0 to +95°C *1	120max	150max	150max
		-20 to 0°C *1	200max	200max	250max
		0 to 15% Load *1	240max	300max	300max
	TEMPERATURE REGULATION[mV]	0 to +65°C	50max	120max	240max
		-20 to +95°C	100max	240max	480max
	DRIFT[mV]	*2	20max	40max	90max
OUTPUT VOLTAGE ADJUSTMENT RANGE[V]	4.50 - 5.50	10.80 - 13.20	21.60 - 26.40		
OUTPUT VOLTAGE SETTING[V]	5.00 - 5.15	12.00 - 12.48	24.00 - 24.96		
PROTECTION CIRCUIT AND OTHERS	OVERCURRENT PROTECTION	Works over 105% of rating and recovers automatically			
	OVERVOLTAGE PROTECTION[V]	6.30 - 7.00	13.90 - 16.35	27.60 - 32.40	
	REMOTE SENSING	Optional (Option:K)	-	-	
	REMOTE ON/OFF	Not provided			
ISOLATION	INPUT-OUTPUT	AC3,000V 1minute, Cutoff current = 10mA, DC500V 50MΩ min (20±15°C)			
	INPUT-FG	AC2,000V 1minute, Cutoff current = 10mA, DC500V 50MΩ min (20±15°C)			
	OUTPUT-FG	AC500V 1minute, Cutoff current = 100mA, DC500V 50MΩ min (20±15°C)			
ENVIRONMENT	OPERATING TEMP., HUMID. AND ALTITUDE	-20 to +95°C (On aluminum base plate), 20 - 95%RH (Non condensing) *4			
	STORAGE TEMP., HUMID. AND ALTITUDE	-20 to +95°C, 20 - 95%RH (Non condensing), 9,000m (30,000 feet) max			
	VIBRATION	10 - 55Hz, 19.6m/s ² (2G), 3minutes period, 60minutes each along X, Y and Z axis			
	IMPACT	196.1m/s ² (20G), 11ms, once each along X, Y and Z axis			
SAFETY AND NOISE REGULATIONS	AGENCY APPROVALS	UL60950-1, C-UL (CSA60950-1), EN62368-1 Complies with DEN-AN			
	CONDUCTED NOISE	Complies with FCC-B, VCCI-B, CISPR-B, EN55011-B, EN55022-B			
	HARMONIC ATTENUATOR	Complies with IEC61000-3-2 (Class A) *3			
OTHERS	CASE SIZE/WEIGHT	74 X 37 X 150mm [2.91 X 1.46 X 5.91 inches] (W X H X D) / 340g max			

*1 Refer to Instruction manual for measuring method of an electrical property.

*2 Drift is the change in DC output for an eight hour period after a half-hour warm-up at 25°C, with the input voltage held constant at the rated input/output.

*3 Please contact us about another class.

*4 Refer to Instruction manual 3.2 and 3.3.

Block diagram

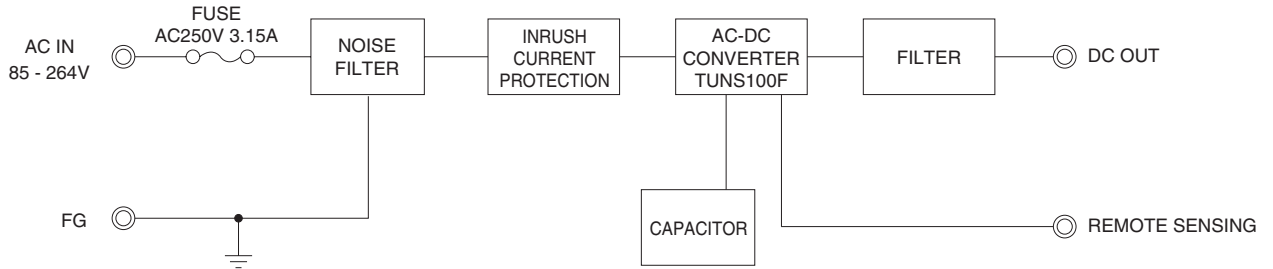

External view

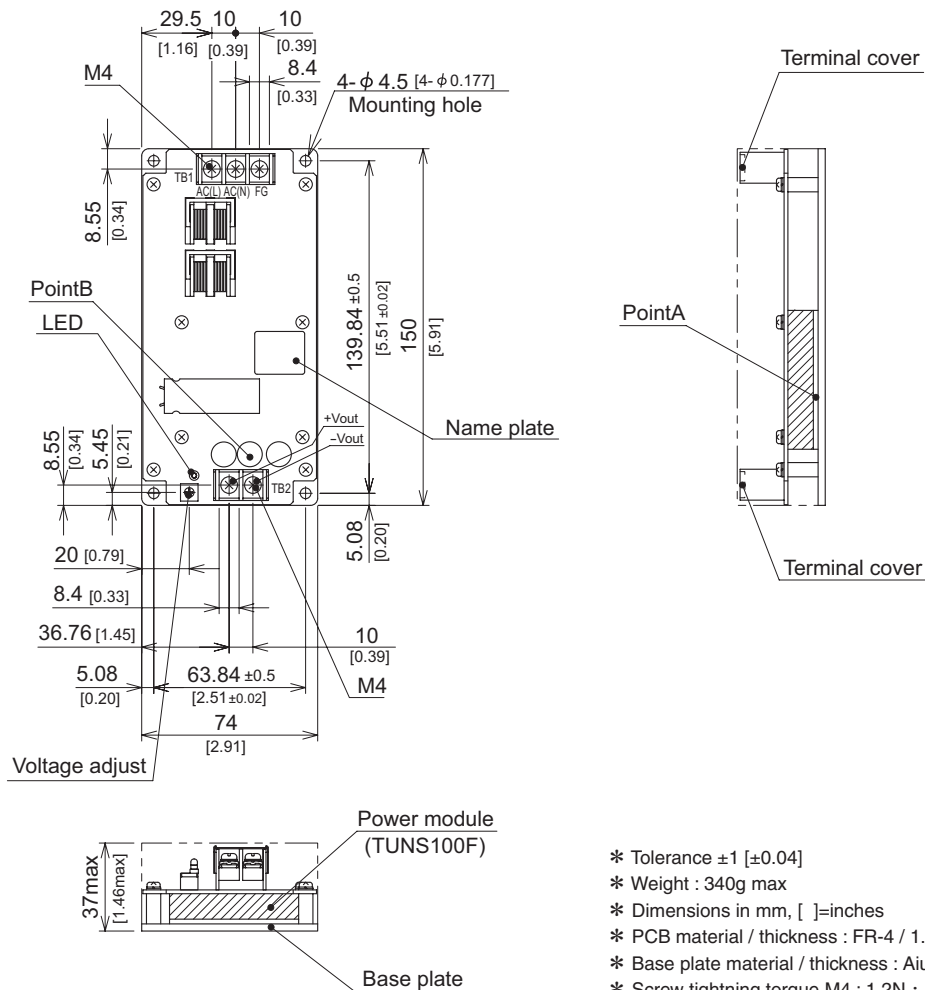

- * Tolerance ±1 [±0.04]
- * Weight : 340g max
- * Dimensions in mm, []=inches
- * PCB material / thickness : FR-4 / 1.6mm [0.06]
- * Base plate material / thickness : Aluminum / 3.0mm [0.12]
- * Screw tightening torque M4 : 1.2N · m (12.2kgf · cm) max
- * Please connect safety ground to the base plate in φ 4.5 [φ 0.177] hole.